



US00D727879S

(12) **United States Design Patent**
Lee et al.

(10) **Patent No.:** **US D727,879 S**
(45) **Date of Patent:** **** Apr. 28, 2015**

- (54) **STAND FOR TV RECEIVER**
- (71) Applicant: **Samsung Electronics Co., Ltd.**,
Suwon-si (KR)
- (72) Inventors: **Sangyoung Lee**, Gwangmyeong-si
(KR); **Kyubok Lee**, Seoul (KR)
- (73) Assignee: **Samsung Electronics Co., Ltd.**,
Suwon-si (KR)

D656,115	S	*	3/2012	Kim et al.	D14/126
D656,471	S	*	3/2012	Han et al.	D14/126
D656,913	S	*	4/2012	Ann et al.	D14/126
D659,663	S	*	5/2012	Xu et al.	D14/126
D662,906	S	*	7/2012	Chiu	D14/126
D664,940	S	*	8/2012	Kim et al.	D14/129
D670,257	S	*	11/2012	Yang et al.	D14/126
D671,923	S	*	12/2012	Seong et al.	D14/239
D680,106	S	*	4/2013	Hwangbo et al.	D14/239
D680,508	S	*	4/2013	Kim et al.	D14/126
D682,227	S	*	5/2013	Lee et al.	D14/126
D694,208	S	*	11/2013	Duys et al.	D14/126

(**) Term: **14 Years**

(21) Appl. No.: **29/494,046**

(22) Filed: **Jun. 17, 2014**

(30) **Foreign Application Priority Data**

Jan. 2, 2014 (KR) 30-2014-0000243

(51) **LOC (10) Cl.** **14-03**

(52) **U.S. Cl.**
USPC **D14/239**

(58) **Field of Classification Search**
USPC D14/239, 211, 238, 251, 253, 371-382,
D14/125-129, 336, 337, 447, 448, 451, 452,
D14/492, 450; 341/12; 345/104, 156, 168,
345/173; 348/180, 184, 325, 739; 349/1, 2,
349/11, 62; 361/679.05-679.07, 679.21;
D6/300, 310-313, 308, 708

See application file for complete search history.

(56) **References Cited**

U.S. PATENT DOCUMENTS

D635,980	S	*	4/2011	Hung	D14/451
D643,389	S	*	8/2011	Lee et al.	D14/126
D643,390	S	*	8/2011	Han et al.	D14/126
D644,620	S	*	9/2011	Song et al.	D14/126

* cited by examiner

Primary Examiner — Randall Gholson

(74) *Attorney, Agent, or Firm* — NSIP Law

(57) **CLAIM**

We claim the ornamental design for a stand for TV receiver, as shown and described.

DESCRIPTION

FIG. 1 is a front perspective view of a stand for TV receiver showing our new design;
FIG. 2 is a front view thereof;
FIG. 3 is a rear view thereof;
FIG. 4 is a left-side view thereof;
FIG. 5 is a right-side view thereof;
FIG. 6 is a top view thereof;
FIG. 7 is a bottom view thereof; and,
FIG. 8 is another front perspective view, in which a TV receiver in broken lines is provided to illustrate an example environment.

The broken lines in the figures show portions of the stand for TV receiver which form no part of the claimed design.
The broken line showing of the TV receiver in FIG. 8 is for environmental purposes only and forms no part of the claimed design.

1 Claim, 8 Drawing Sheets

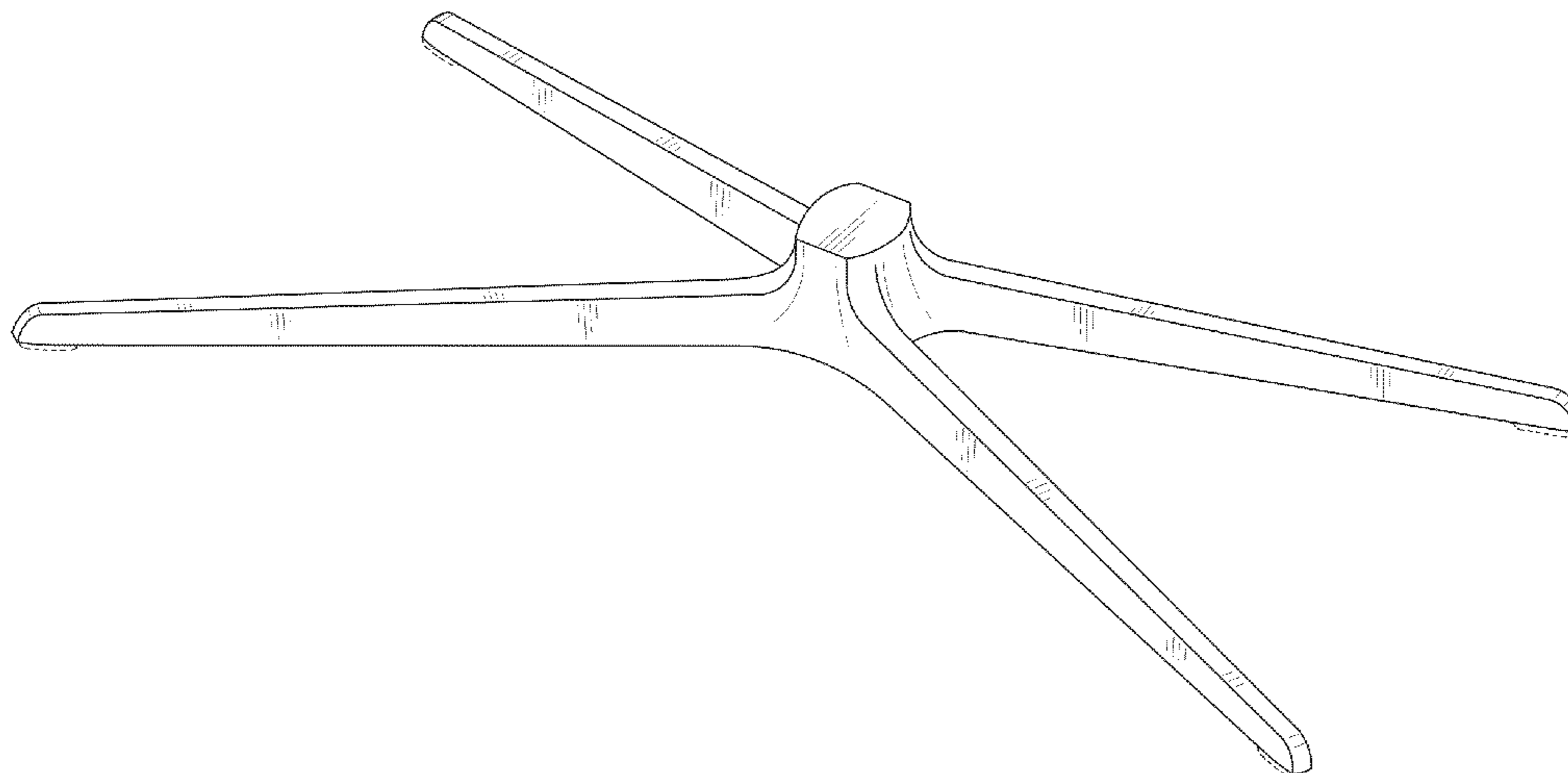

FIG. 1

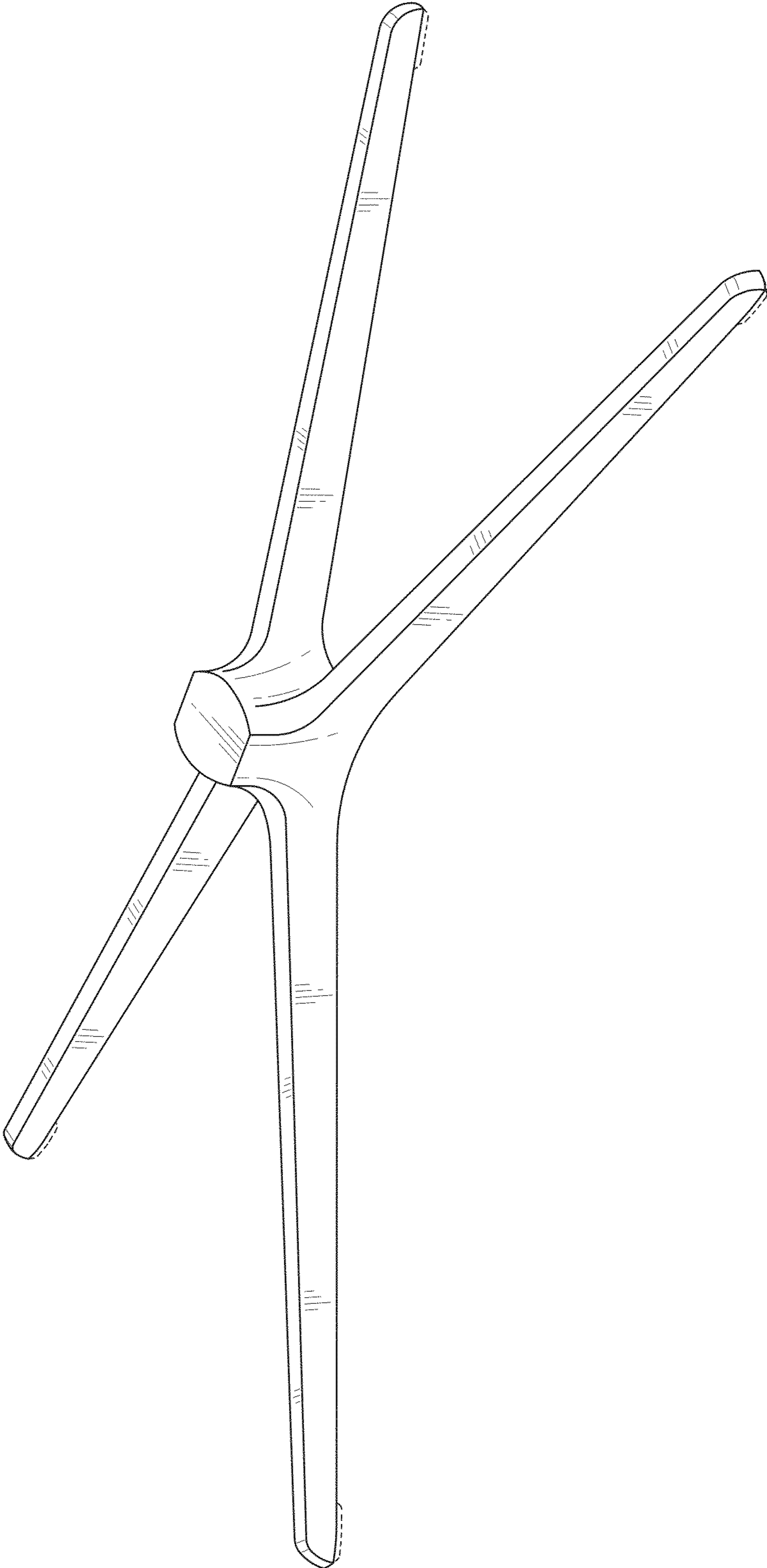

FIG. 2

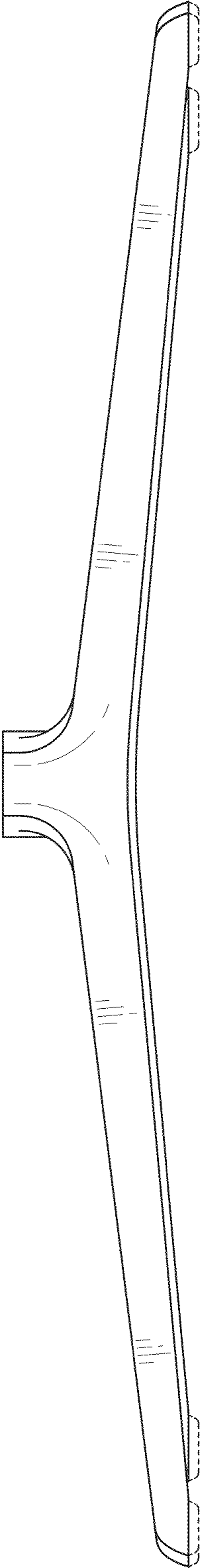

FIG. 3

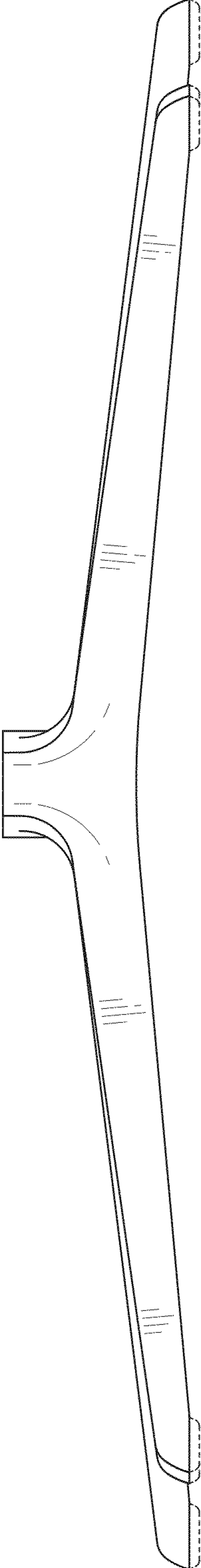

FIG. 4

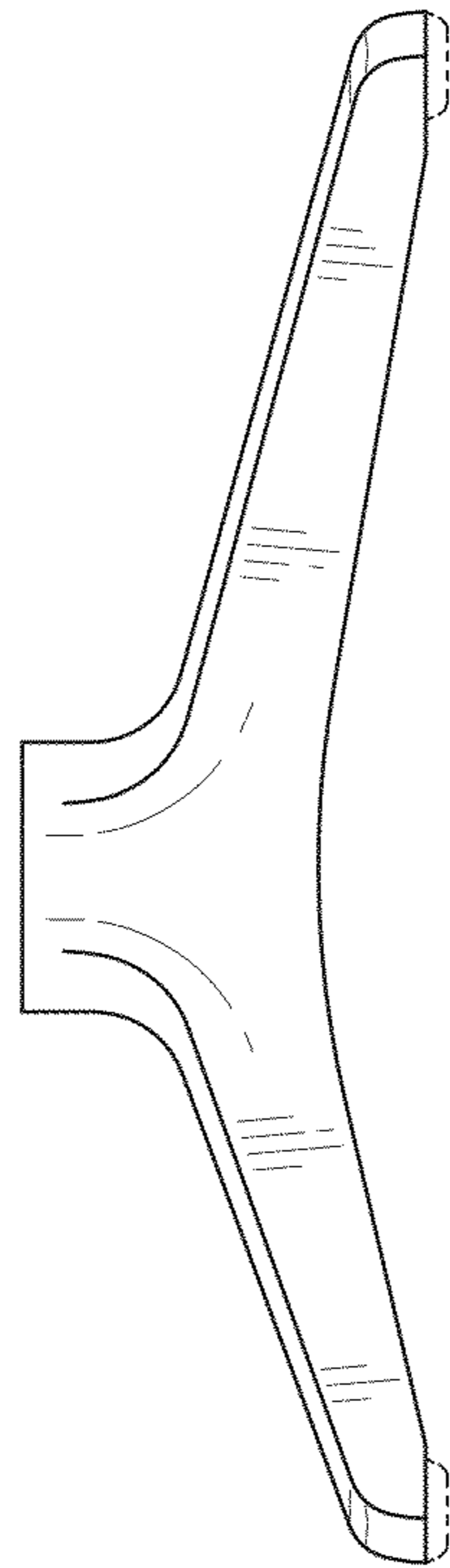

FIG. 5

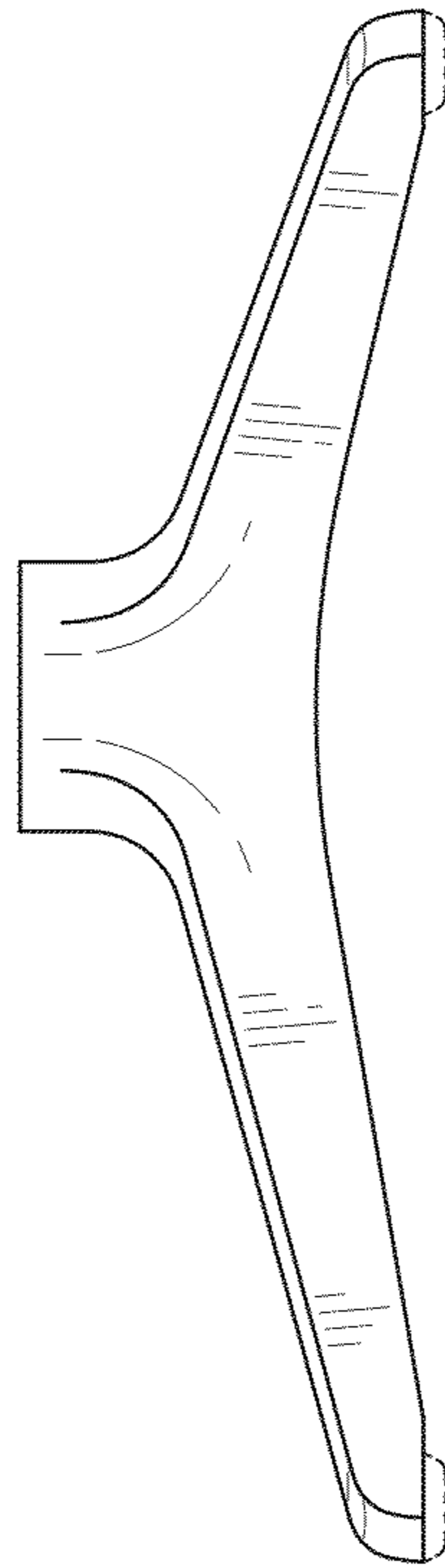

FIG. 6

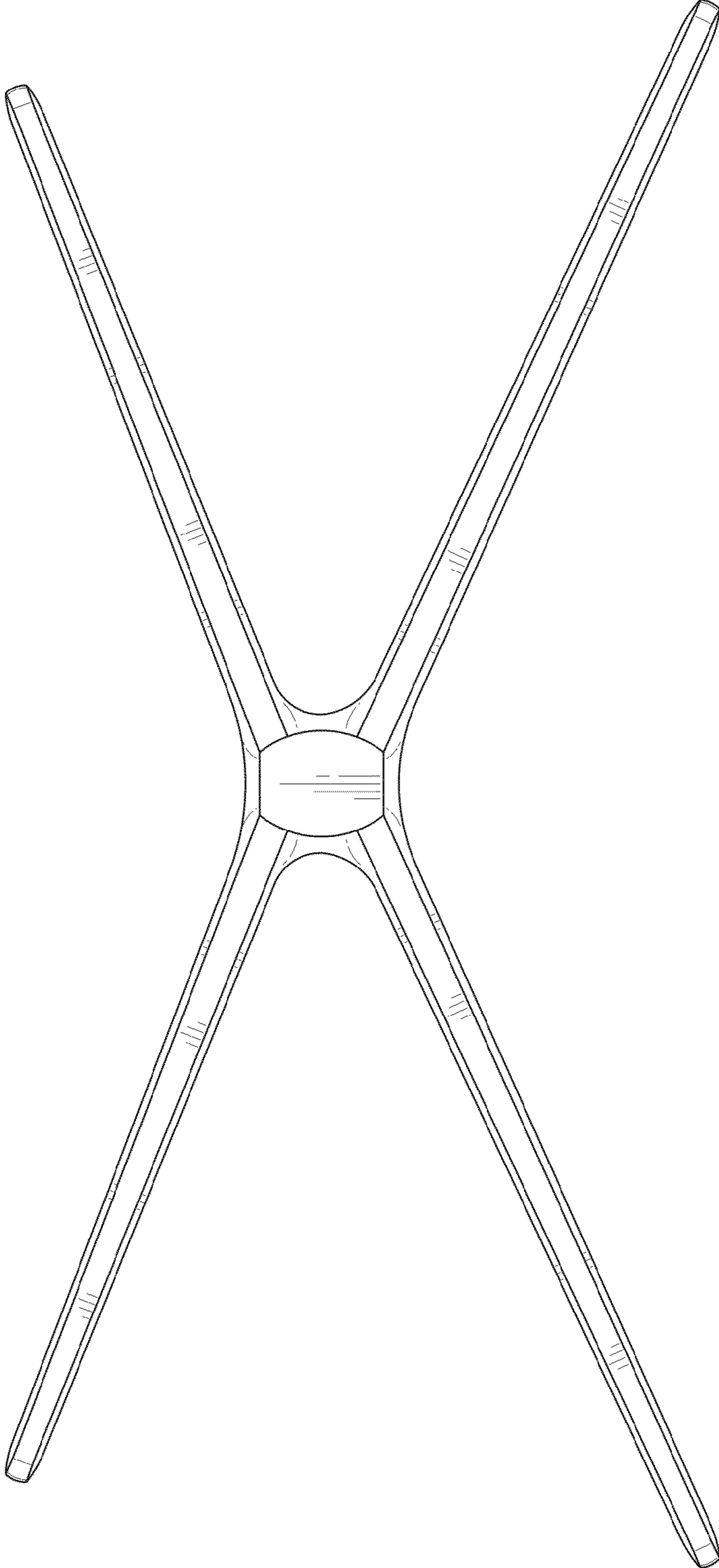

FIG. 7

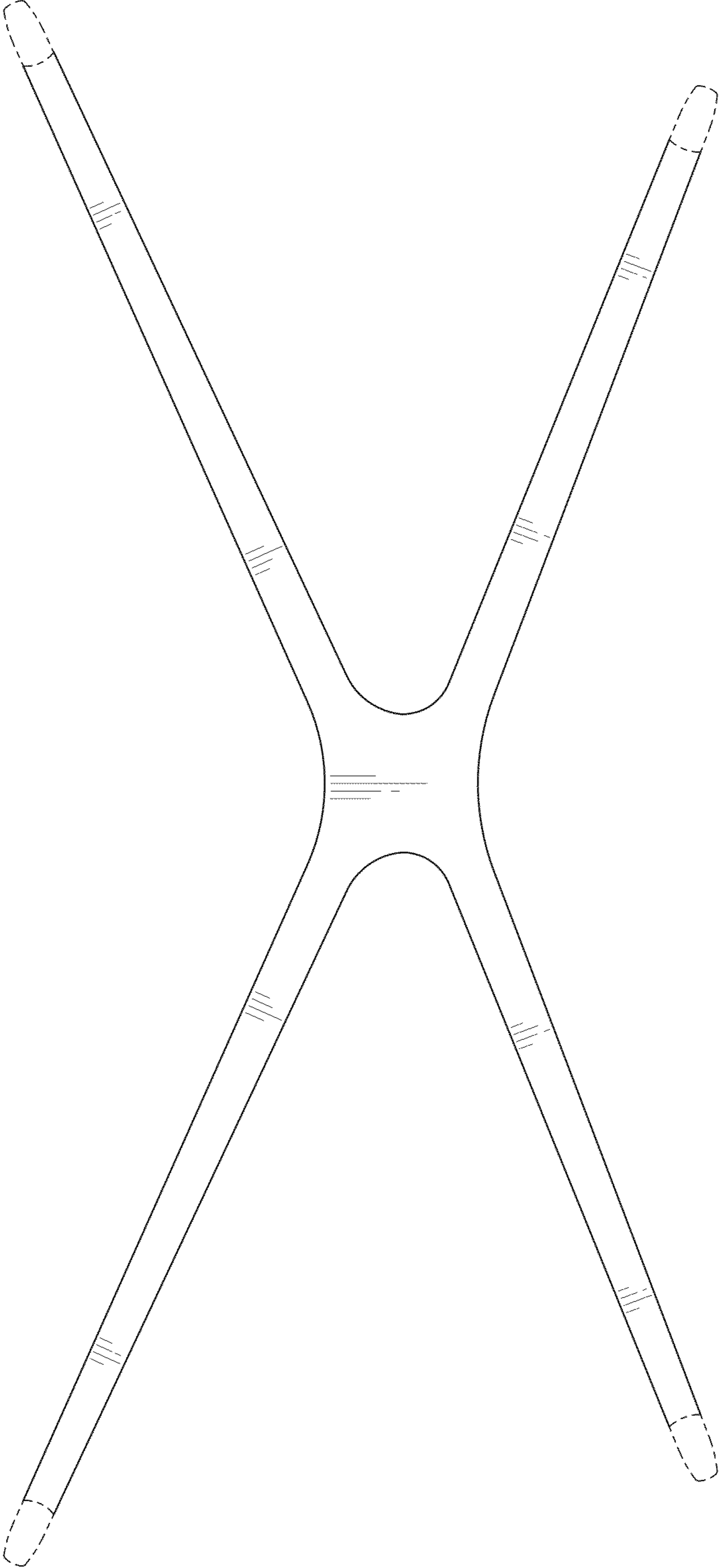

FIG. 8

