



US00D727812S

(12) **United States Design Patent**
Hanson et al.

(10) **Patent No.:** **US D727,812 S**
(45) **Date of Patent:** **** Apr. 28, 2015**

(54) **SIDE MIRROR OF A TRUCK**

(71) Applicant: **Caterpillar Inc.**, Peoria, IL (US)

(72) Inventors: **Eric J. Hanson**, Valparaiso, IN (US);
Joseph F. DeNatale, Greensboro, NC (US)

(73) Assignee: **Caterpillar Inc.**, Peoria, IL (US)

(**) Term: **14 Years**

(21) Appl. No.: **29/448,314**

(22) Filed: **Mar. 12, 2013**

Related U.S. Application Data

(62) Division of application No. 29/413,736, filed on Feb. 20, 2012, now Pat. No. Des. 680,929, which is a division of application No. 29/381,459, filed on Dec. 20, 2010, now Pat. No. Des. 660,207.

(51) **LOC (10) Cl.** **12-16**

(52) **U.S. Cl.**
USPC **D12/187**

(58) **Field of Classification Search**
USPC D12/187, 188-189; D6/300, 309;
359/838, 841-844, 868, 871, 604, 881,
359/514, 866; 248/479-483, 475.1
See application file for complete search history.

(56) **References Cited**

U.S. PATENT DOCUMENTS

2,860,548	A *	11/1958	Bruce et al.	409/103
3,277,678	A *	10/1966	Booth	74/98
D335,272	S	5/1993	Allendorph et al.	
D366,640	S	1/1996	Tucker et al.	
D367,027	S	2/1996	Onopa	
D387,317	S	12/1997	Lang	
D394,026	S	5/1998	Hellhake et al.	
D397,072	S	8/1998	Hellhake et al.	
D407,360	S	3/1999	Hellhake et al.	

D407,361	S *	3/1999	Lang	D12/187
D416,221	S	11/1999	Sutton et al.	
D421,412	S	3/2000	Sutton et al.	
D437,574	S	2/2001	Beigel	
6,286,968	B1	9/2001	Sailer et al.	
D452,671	S	1/2002	Lang	
D457,114	S *	5/2002	Lang et al.	D12/187
D458,875	S	6/2002	Maher et al.	
D460,023	S	7/2002	Beigel	

(Continued)

OTHER PUBLICATIONS

http://www.innerauto.com/Jeep_Parts/Jeep_Fender_Flare/; Jeep aftermarket fender flare; accessed May 11, 2010.

(Continued)

Primary Examiner — Katrina A Betton

(74) *Attorney, Agent, or Firm* — Finnegan, Henderson, LLP

(57) **CLAIM**

The ornamental design for a side mirror of a truck, as shown and described.

DESCRIPTION

FIG. 1 is a front, left perspective view of a side mirror of a truck showing our new design, the portions of the truck shown in broken lines are for illustrative purposes only and form no part of the claimed design;
FIG. 2 is an enlarged front, left perspective view thereof, without the truck portions shown;
FIG. 3 is an enlarged left side view thereof;
FIG. 4 is an enlarged right side view thereof;
FIG. 5 is an enlarged top view thereof;
FIG. 6 is an enlarged front view thereof;
FIG. 7 is an enlarged rear view thereof; and,
FIG. 8 is an enlarged bottom view thereof.
The broken lines of the figures are included for the purposes of illustrating environmental structure and form no part of the claimed design.

1 Claim, 8 Drawing Sheets

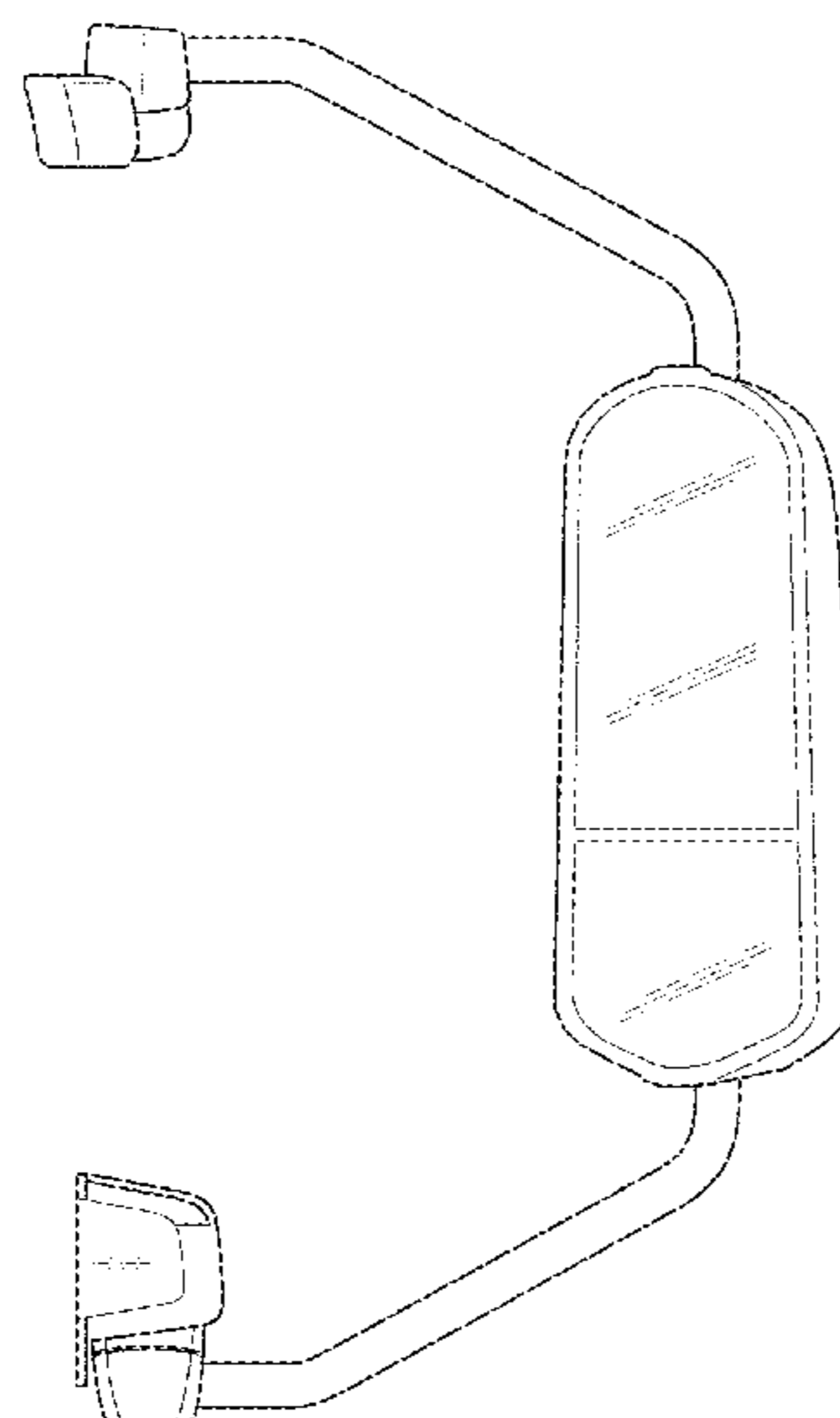

(56)

References Cited

U.S. PATENT DOCUMENTS

D460,393	S	7/2002	Kidd	
D466,455	S	12/2002	Kidd et al.	
D482,993	S	12/2003	Conway et al.	
6,764,207	B2	7/2004	Abalos et al.	
D498,193	S	11/2004	Metros et al.	
6,814,336	B2 *	11/2004	Courbon	248/478
D512,355	S *	12/2005	Courbon	D12/187
D514,488	S *	2/2006	Perfetti et al.	D12/187
D526,258	S *	8/2006	Branham et al.	D12/187
7,113,340	B2 *	9/2006	Lang et al.	359/599
D545,255	S	6/2007	Angelo et al.	
7,232,234	B2	6/2007	Branham et al.	
D552,020	S *	10/2007	Hofle	D12/187
D552,515	S	10/2007	Prosser et al.	
7,318,650	B2	1/2008	Courbon	
D581,333	S	11/2008	Enz	
D593,396	S	6/2009	Habib	
D610,060	S *	2/2010	Meier et al.	D12/187
D612,309	S	3/2010	Beigel et al.	
2009/0161378	A1	6/2009	Enz	

OTHER PUBLICATIONS

<http://www.ridgelineownersclub.com/forums/showthread.php?t=28525&page=20>; Honda Ridgeline custom fender conversion; accessed May 11, 2010.
http://www.truckcessories.ca/store/index.php?main_page=index&cPath=34; Dodge Ram aftermarket fender flare (bolt access from the front); accessed May 11, 2010.

<http://www.ultimatecarpage.com/car/2535Honda-Ridgeline-All-Terrain-Concept.html>; Honda Ridgeline—OEM concept package; accessed May 11, 2010.
<http://4wheelonline.com/jeep/StampedeFenderFlares.54162>; Stampede truck accessories: Aftermarket fender flare for GMC/Chevy truck; accessed May 11, 2010.
<http://www.crawltech.com.side-x-side-parts-5/polaris-rzr-parts-7/rzr-body-parts-93/polaris-rzr-fender-flares-286.html>; Polaris ATV fender flare; aftermarket accessory; accessed May 11, 2010.
<http://www.jeepcommander.com/forums/showthread.php?t=11440>; Jeep custom pack (by AEV) with new flares; accessed May 11, 2010.
<http://www.kenworth.com/brochures/T800.pdf>; Kenworth T800 cab; accessed May 11, 2010.
<http://www.fordvehicles.com/trucks/f150/gallery/photos/>; Ford F150 door (on Raptor model); accessed May 11, 2010.
<http://www.fordvehicles.com/trucks/superduty/gallery/photos/>; 2011 Ford Super Duty; accessed May 11, 2010.
http://www.macktrucks.com/assets/MackMarketing/Brochures/BullDgLnBro/4601_BullDgLnBro.pdf; Mack Pinnacle; accessed May 12, 2010.
http://www.internationaltrucks.com/InternationalTrucks/V2Global/Brochures/9200i_brochure.pdf; International 9200i; accessed May 12, 2010.
<http://velvac.thomasnet.com/item/rors-mirror-systems-recreational-specialty-vehicle/7-x-16-heated-angle-back-mirror-with-marker-light/708331?&plpvi=10&origin=keyword&by-prod&filter=0>; Velvac 708331 side mirror; accessed May 12, 2010.
<http://www.sureplus.com/products/westcoast.htm>; Sure Plus mirror; accessed May 12, 2010.

* cited by examiner

FIG. 1

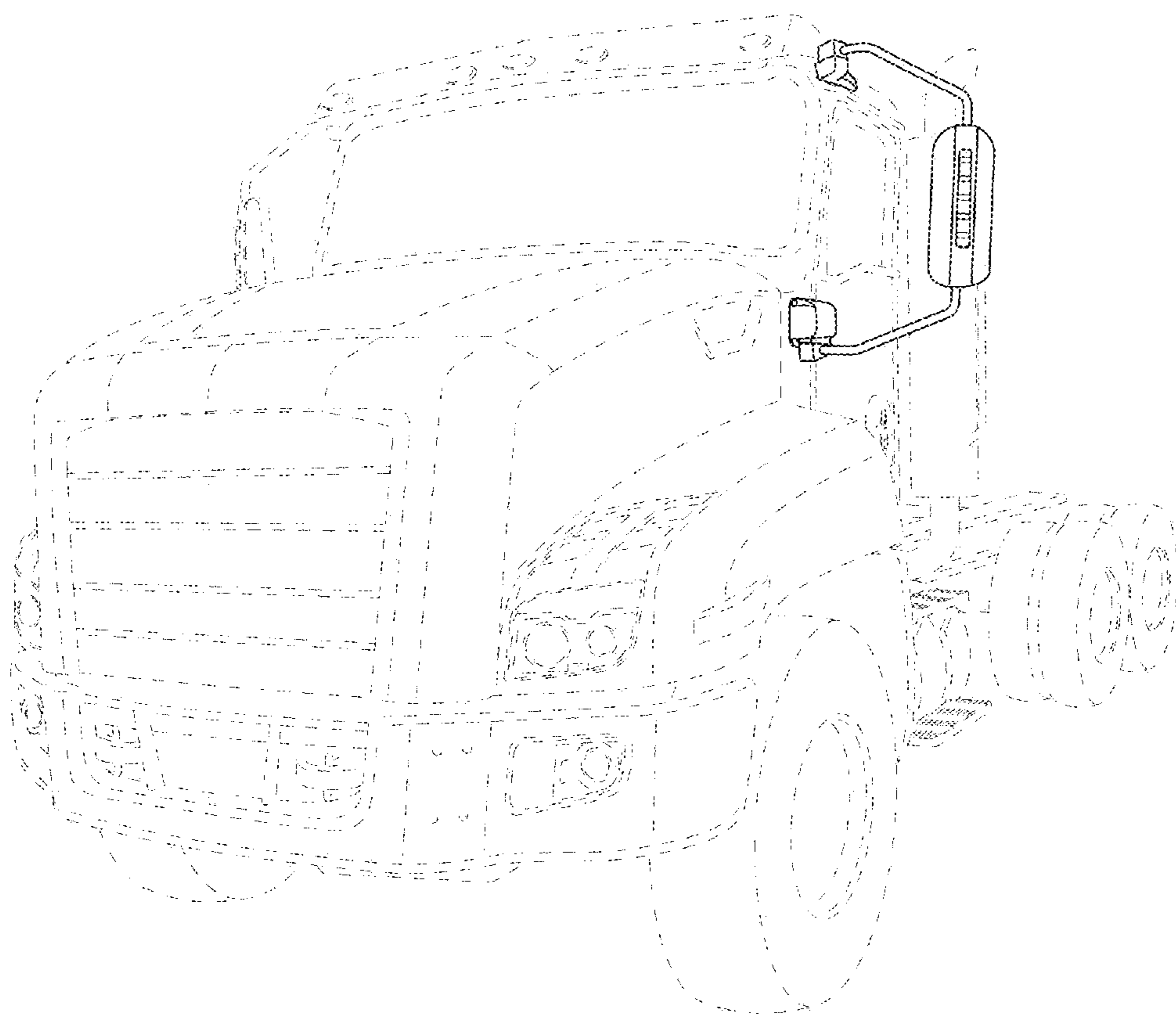

FIG. 2

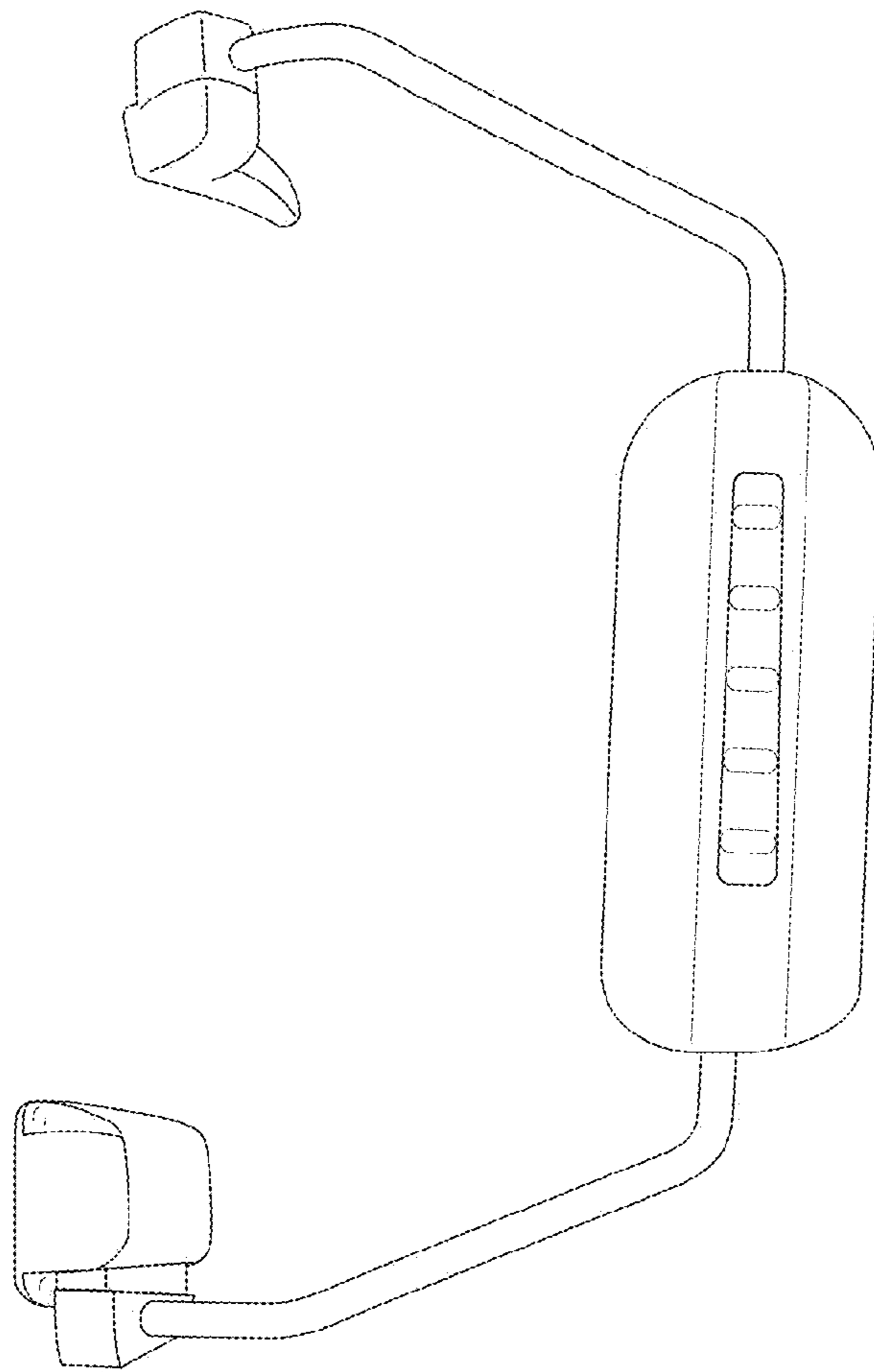

FIG. 3

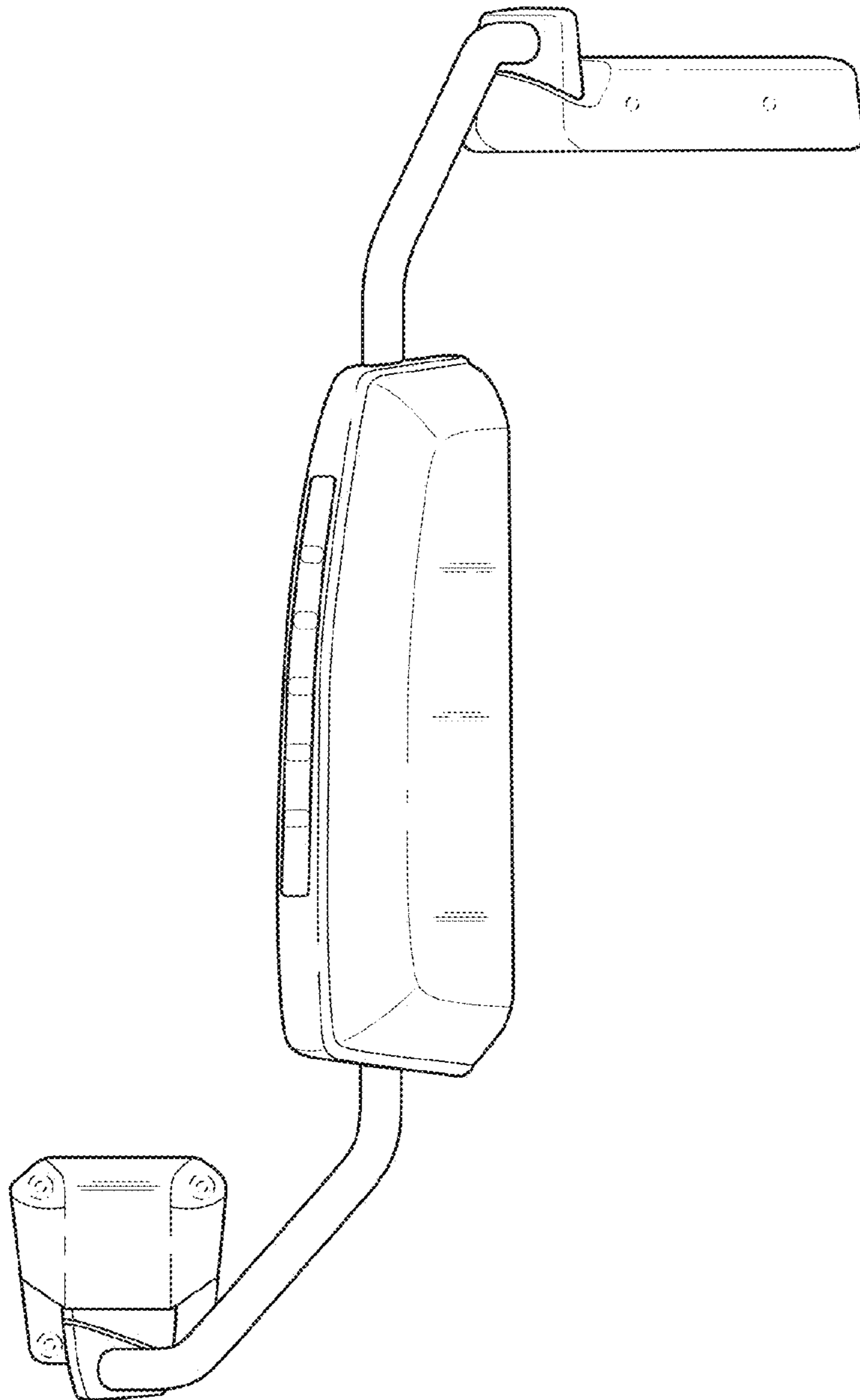

FIG. 4

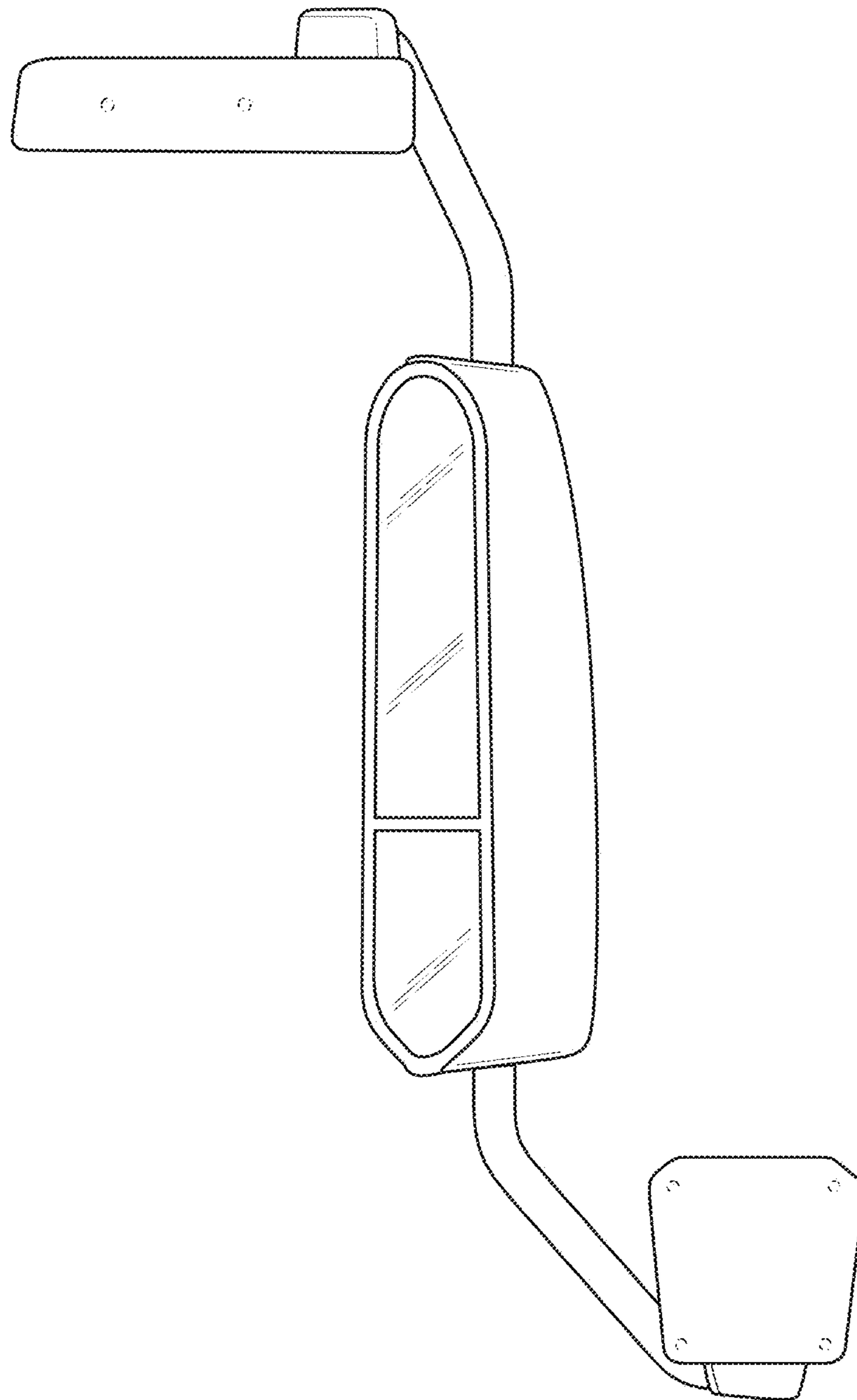

FIG. 5

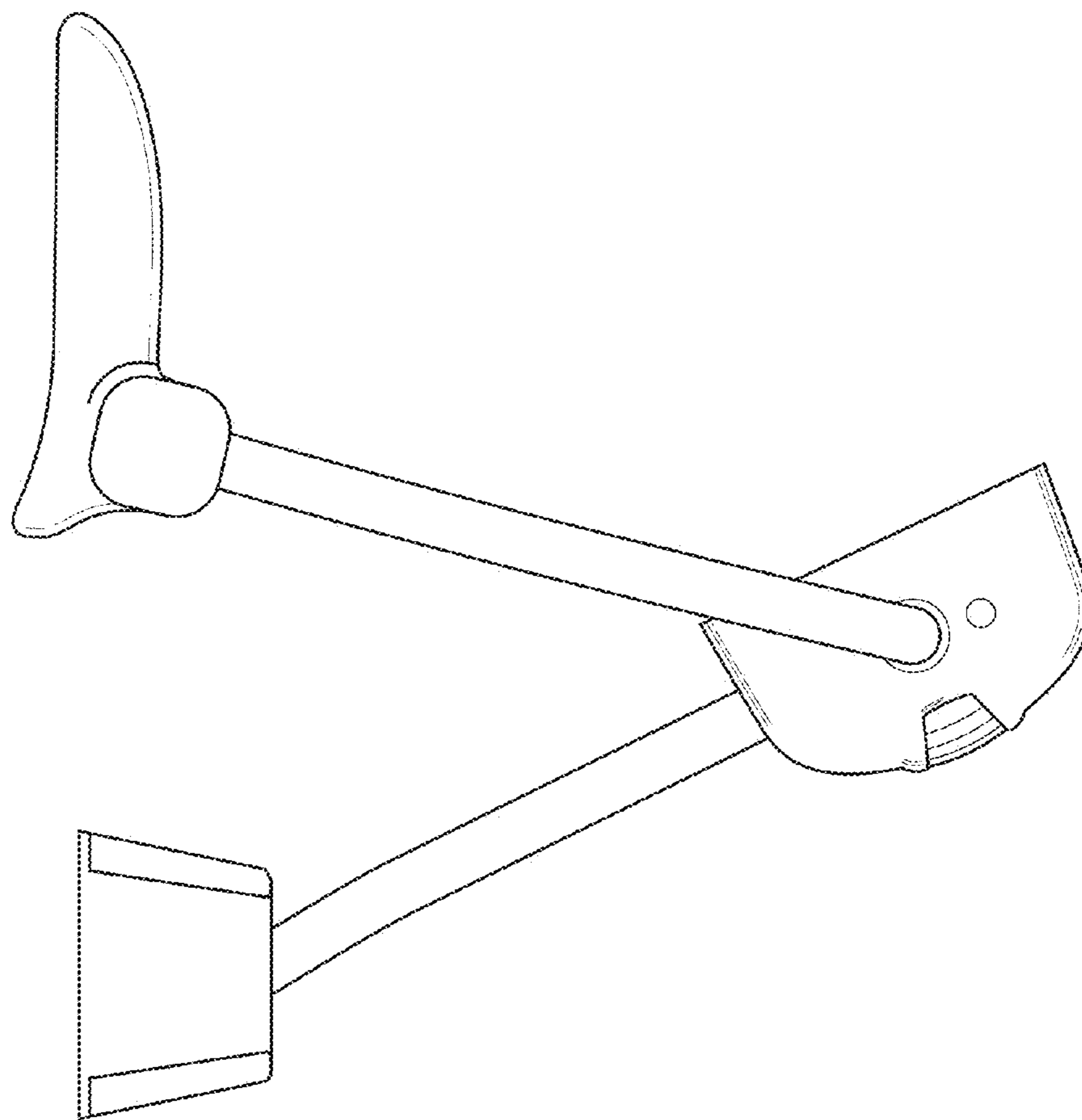

FIG. 6

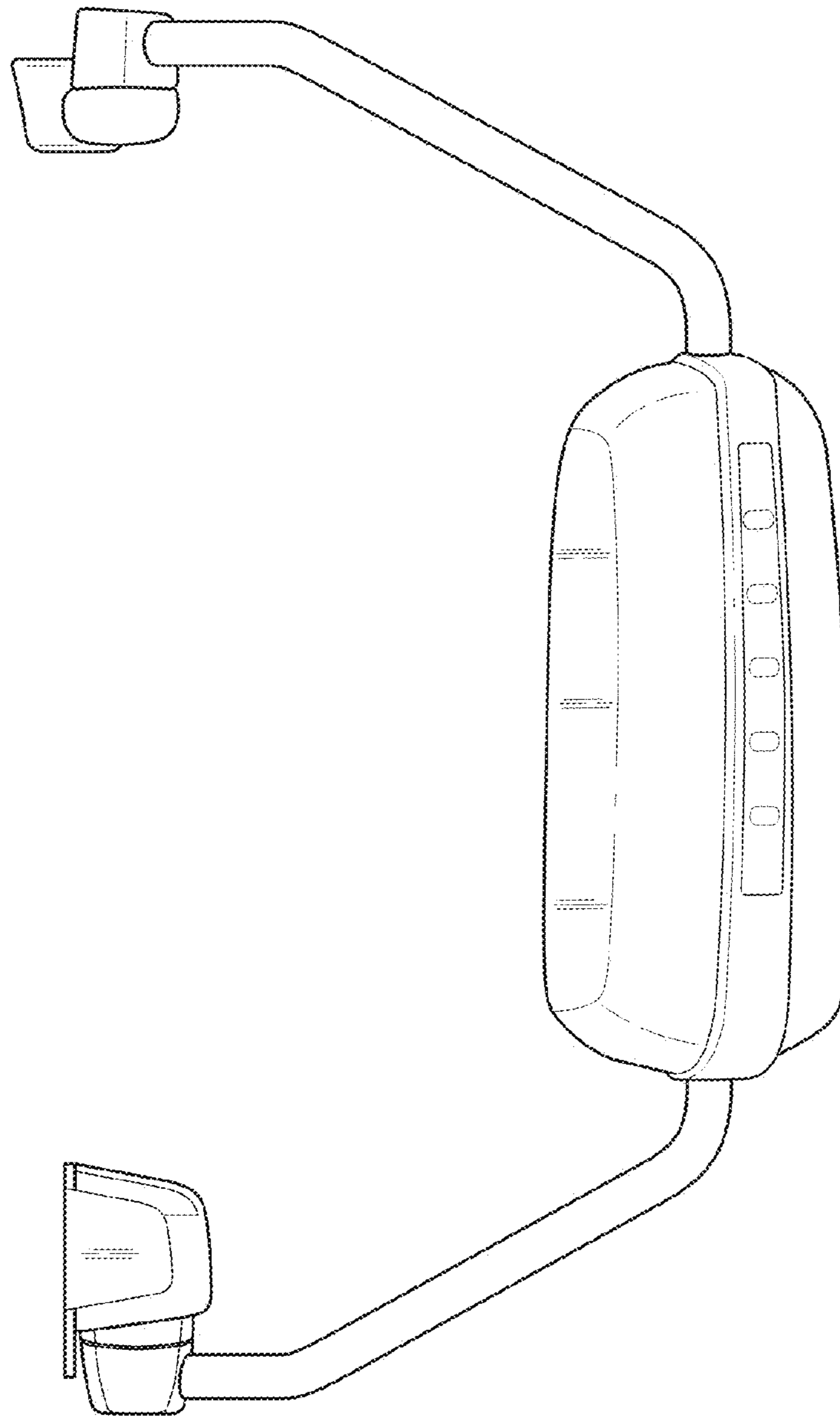

FIG. 7

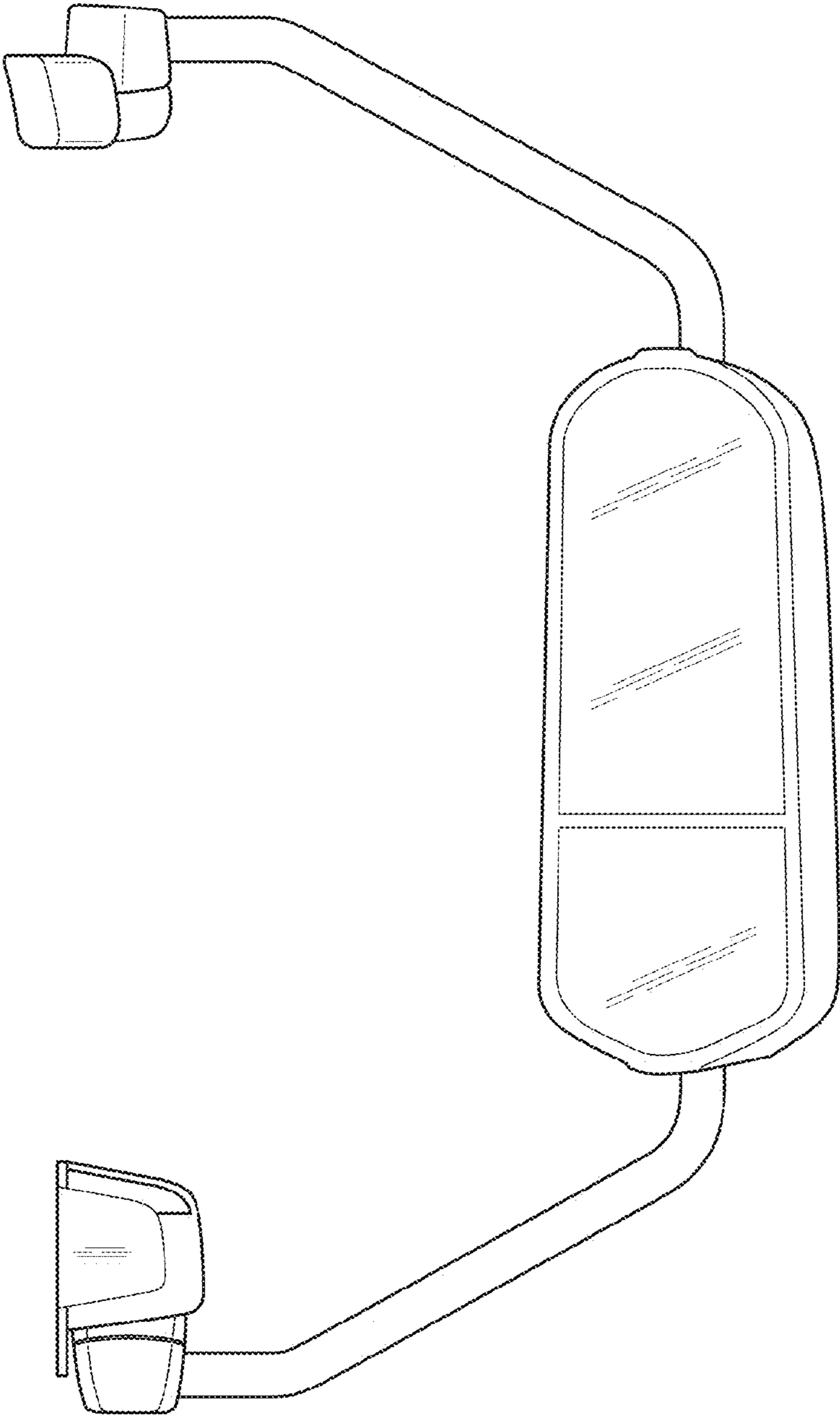

FIG. 8

