



US00D727778S

(12) **United States Design Patent**
Levinson et al.

(10) **Patent No.:** **US D727,778 S**
(45) **Date of Patent:** **** *Apr. 28, 2015**

- (54) **CURLYCUE EARRING SUPPORT**
- (71) Applicants: **Robin A. Levinson**, Fort Lauderdale, FL (US); **Ruben Derlly**, Fort Lauderdale, FL (US)
- (72) Inventors: **Robin A. Levinson**, Fort Lauderdale, FL (US); **Ruben Derlly**, Fort Lauderdale, FL (US)
- (73) Assignee: **Earring Support, LLC**, Fort Lauderdale, FL (US)

(*) Notice: This patent is subject to a terminal disclaimer.

(**) Term: **14 Years**

(21) Appl. No.: **29/473,110**

(22) Filed: **Nov. 19, 2013**

(51) **LOC (10) Cl.** **11-01**

(52) **U.S. Cl.**
USPC **D11/86**

(58) **Field of Classification Search**
 CPC A44C 5/02
 USPC D11/1-2, 7, 40-44, 46-49, 53, 56, 57,
 D11/59-61, 63, 65, 79-83, 86-87, 89-90,
 D11/91-92, 99, 101, 106, 114-116,
 D11/200-201; 63/18-20
 See application file for complete search history.

(56) **References Cited**

U.S. PATENT DOCUMENTS

2,931,196 A	4/1960	Liftman
3,446,033 A	5/1969	Driscoll
3,563,056 A	2/1971	Noel

3,630,048 A	12/1971	Masters	
3,828,577 A *	8/1974	Haynes	63/33
4,688,400 A	8/1987	Chioffe	

(Continued)

FOREIGN PATENT DOCUMENTS

JP 3284204 3/1990

Primary Examiner — Zenia Bennett

(74) *Attorney, Agent, or Firm* — Robert M. Schwartz

(57) **CLAIM**

The ornamental design for a curlycue earring support, as shown and described.

DESCRIPTION

FIG. 1 is a front view of a first embodiment of a left curlycue earring support showing the new design.

FIG. 2 is a top view of the left curlycue design.

FIG. 3 is a bottom view of the left curlycue design.

FIG. 4 is a rear view of the left curlycue design.

FIG. 5 is a right side view of the left curlycue design.

FIG. 6 is a left side view of the left curlycue design.

FIG. 7 is a front perspective view of the left curlycue design.

FIG. 8 is a front view of a second embodiment of a right curlycue earring support showing the new design.

FIG. 9 is a top view of the right curlycue design.

FIG. 10 is a bottom view of the right curlycue design.

FIG. 11 is a rear view of the right curlycue design.

FIG. 12 is a right side view of the right curlycue design.

FIG. 13 is a left side view of the right curlycue design; and,

FIG. 14 is a front perspective view of the right curlycue design.

The broken lines shown in the figures are provided for illustrative purposes only and form no part of the claimed design. Specifically, the broken lines represent non-claimed subject matter.

1 Claim, 6 Drawing Sheets

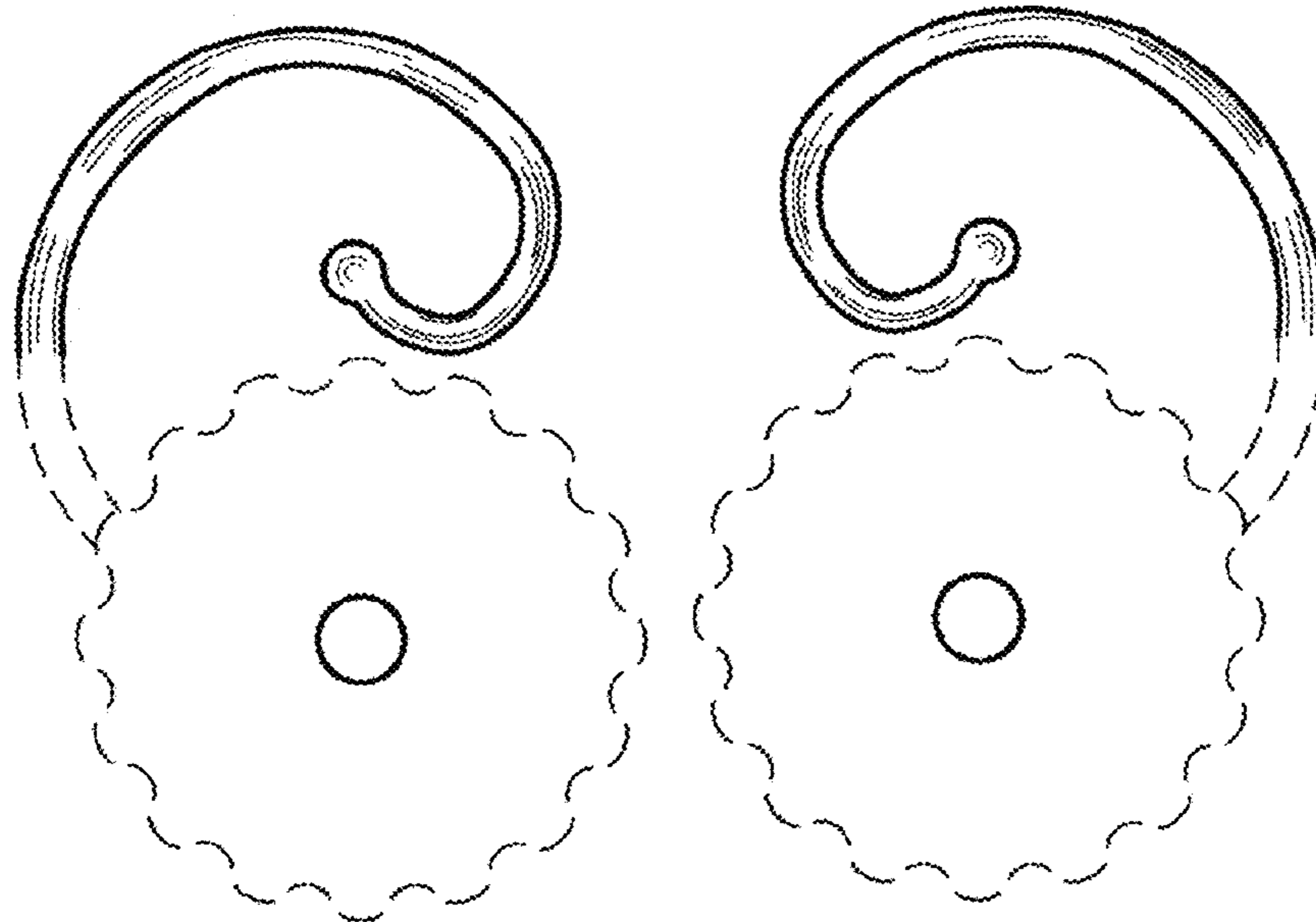

(56)

References Cited

U.S. PATENT DOCUMENTS

4,704,878 A *	11/1987	Saraga	63/14.1	5,588,309 A	12/1996	Chioffe	
D295,151 S *	4/1988	Saraga	D11/42	5,906,114 A	5/1999	Rissin	
D298,611 S *	11/1988	Saraga	D11/42	D420,304 S *	2/2000	Porcell	D11/40
5,074,128 A *	12/1991	Kowalski	63/12	D461,140 S	8/2002	Benhamou	
D337,963 S *	8/1993	Gladorisi	D11/40	6,718,796 B2	4/2004	Baum et al.	
D340,527 S *	10/1993	Goodell	D24/211	D533,803 S *	12/2006	Corso	D11/42
D344,910 S *	3/1994	Nelson	D11/79	7,818,852 B2	10/2010	Van der Gref	
D374,637 S *	10/1996	Esser	D11/44	8,261,576 B1 *	9/2012	Clements	63/12
				2002/0124364 A1	9/2002	Rissin et al.	
				2007/0163298 A1	7/2007	Van der Gref	

* cited by examiner

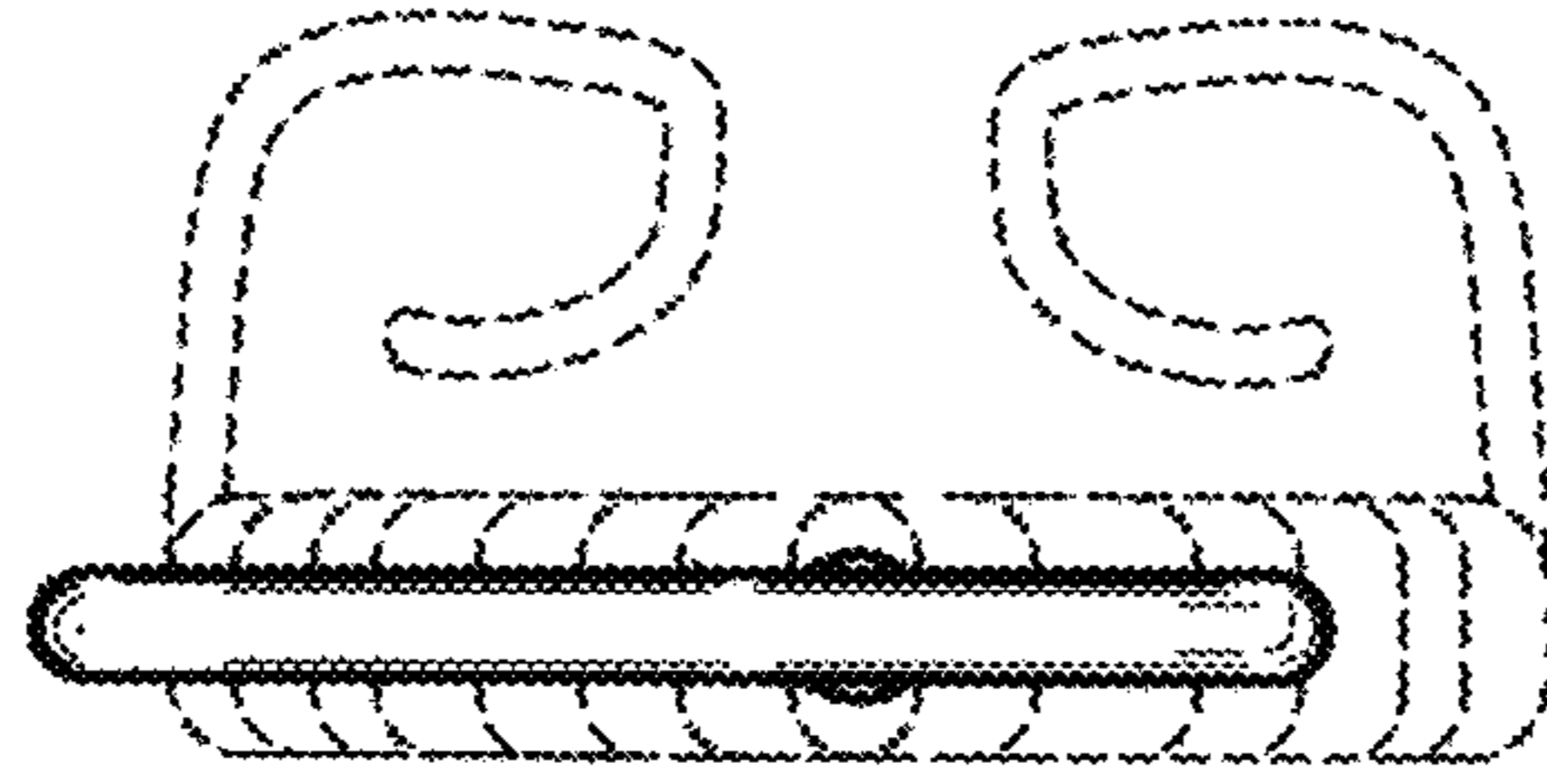

FIG. 2

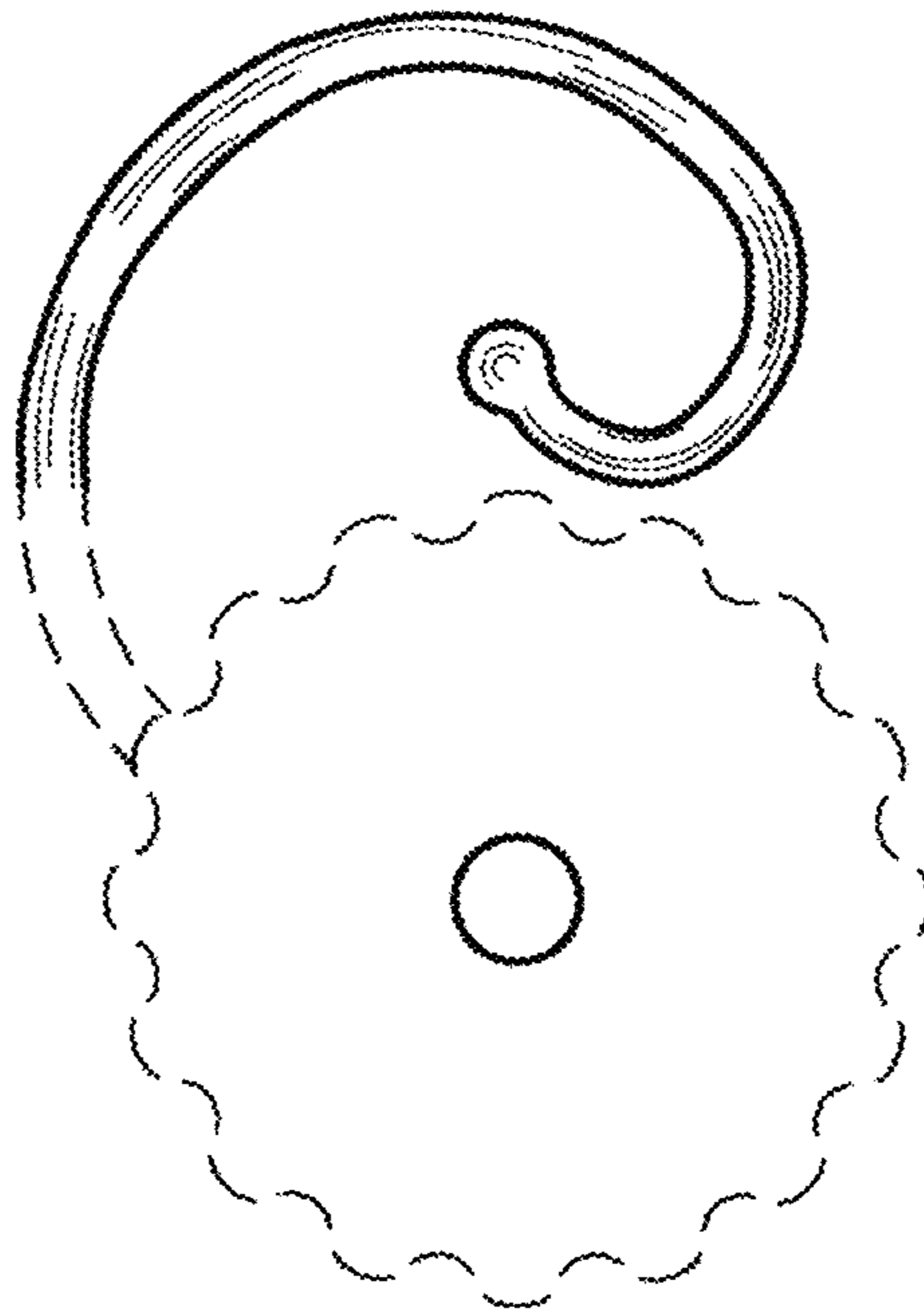

FIG. 1

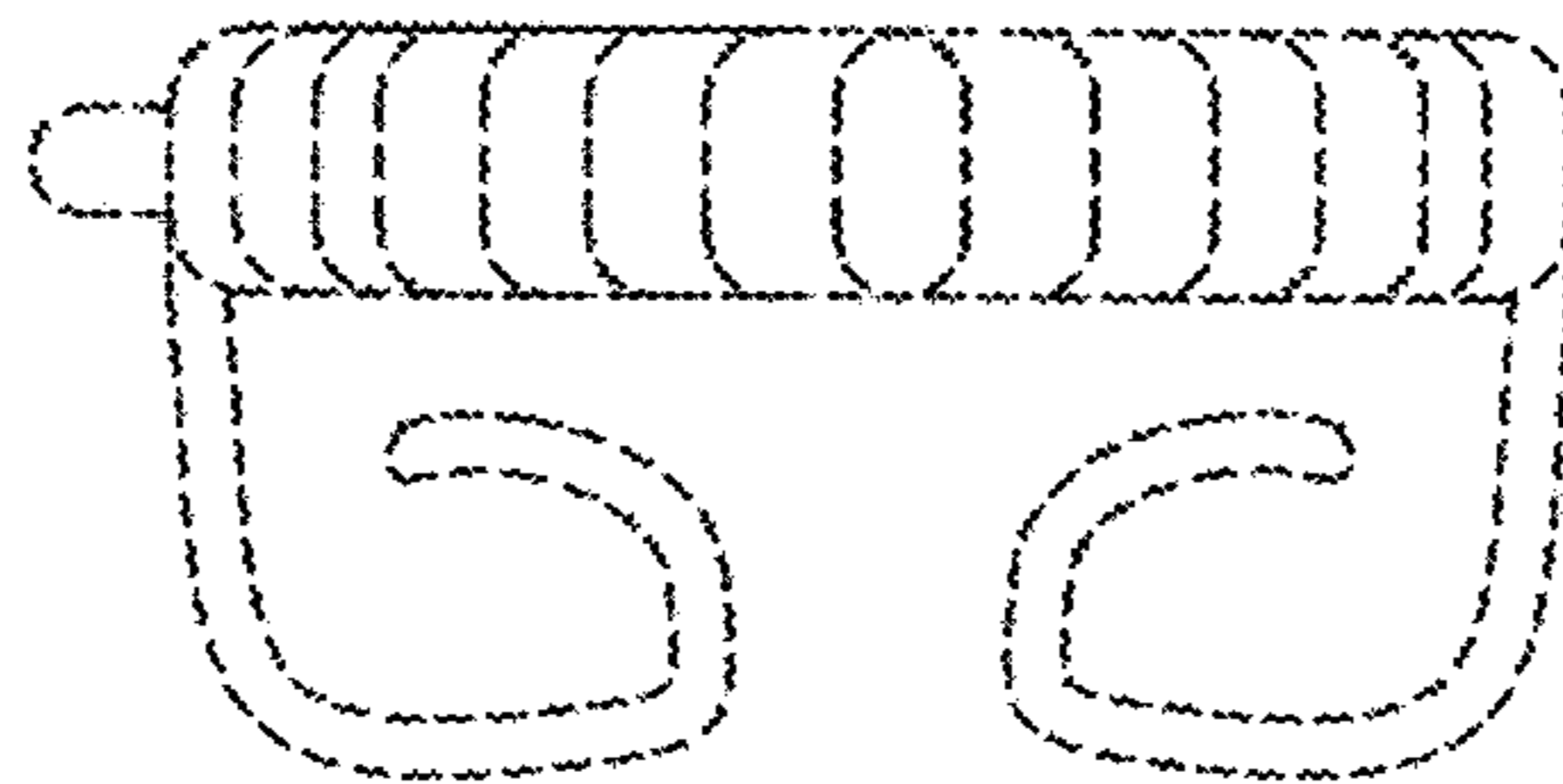

FIG. 3

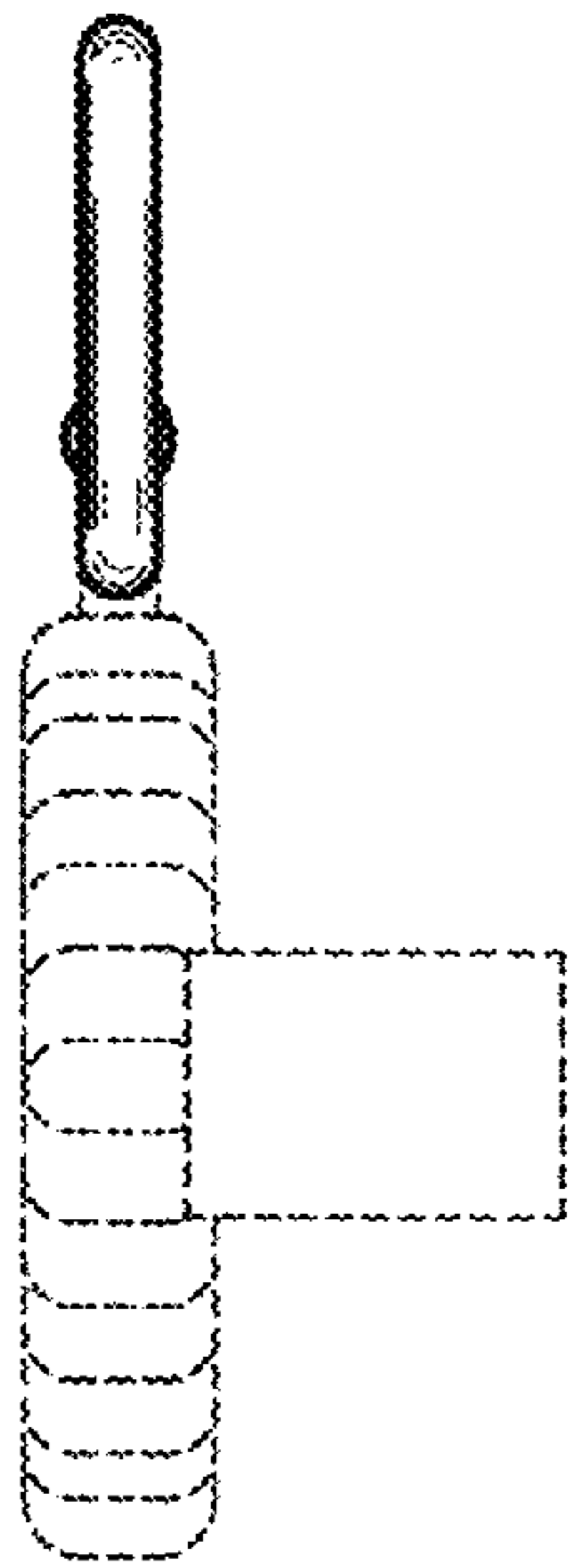

FIG. 5

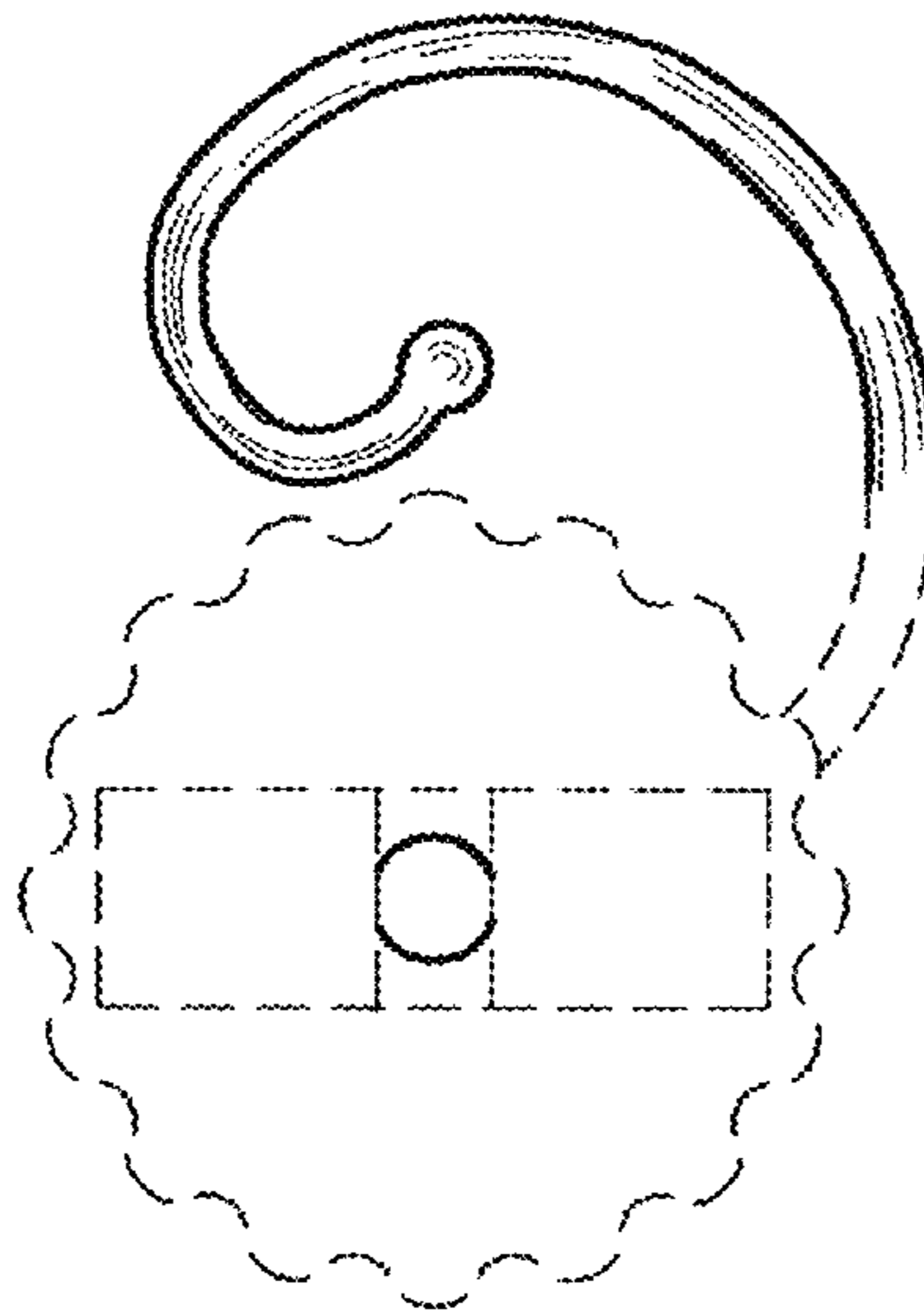

FIG. 4

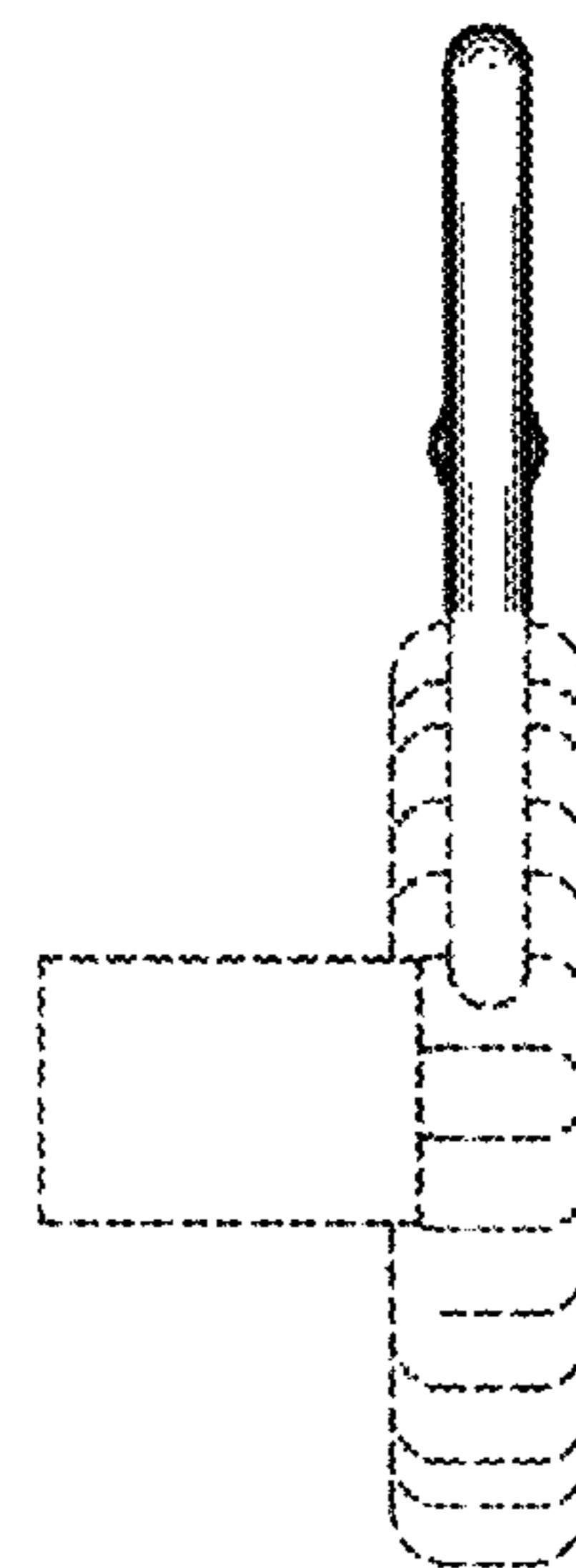

FIG. 6

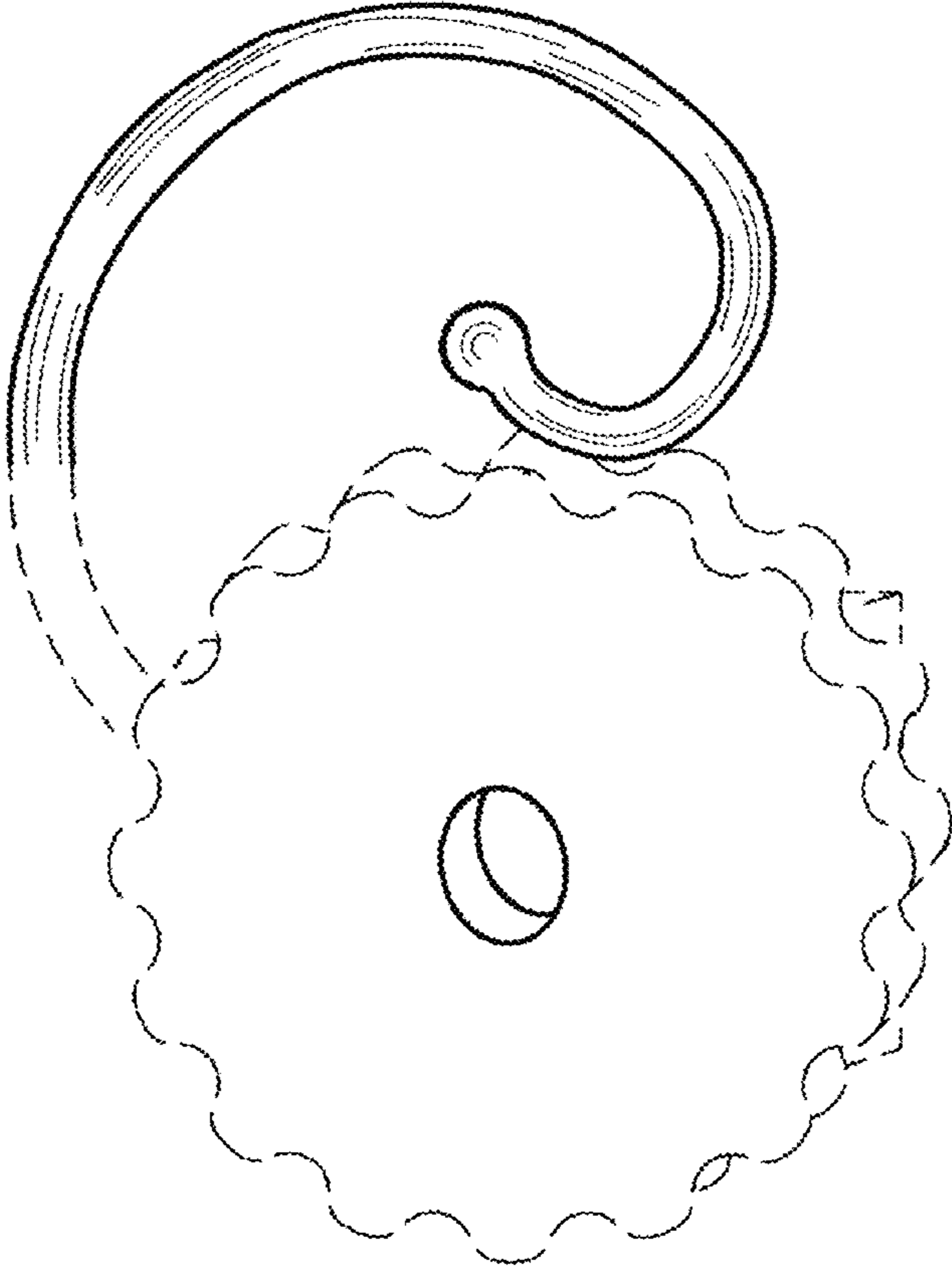

FIG.7

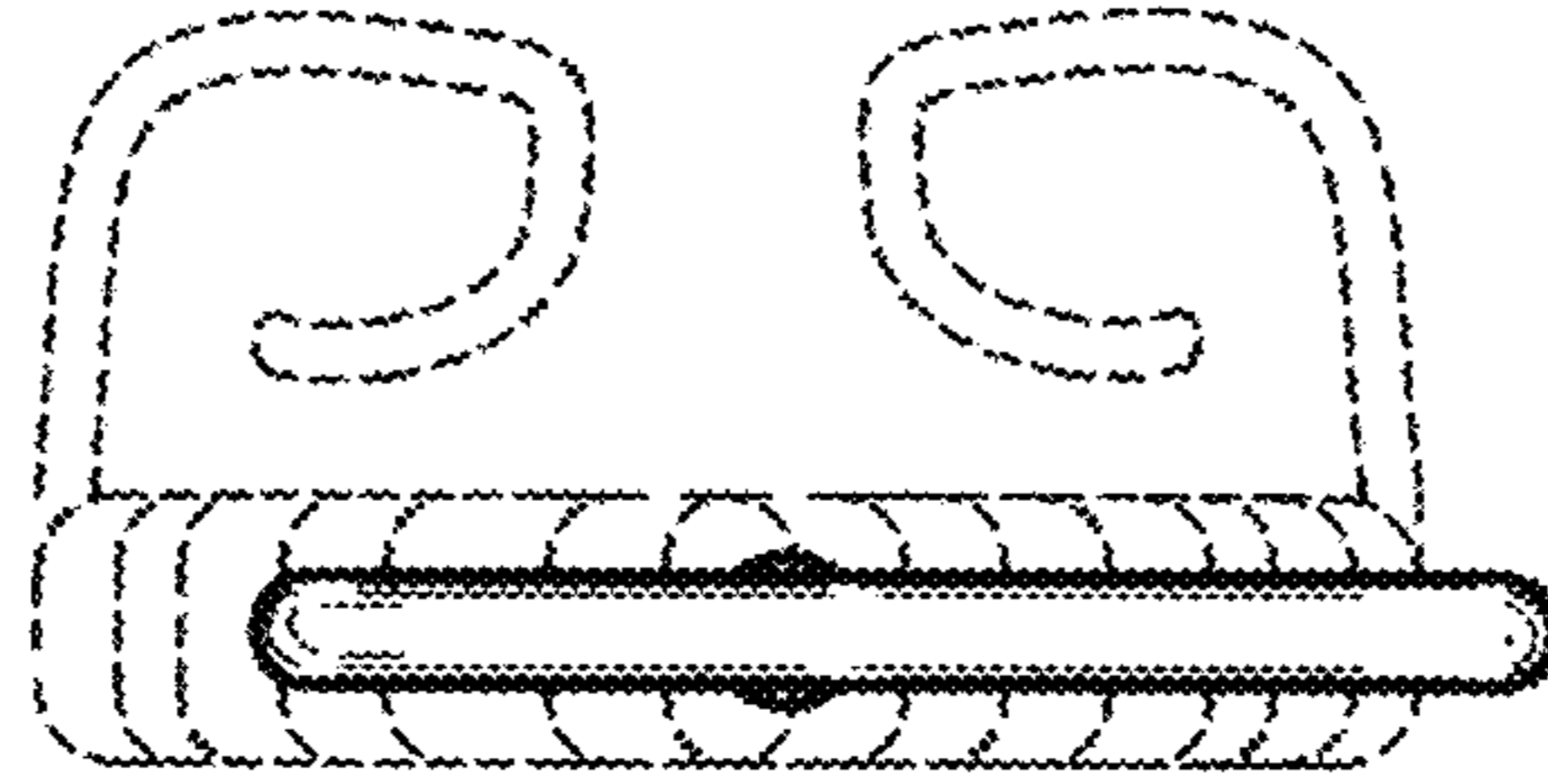

FIG. 9

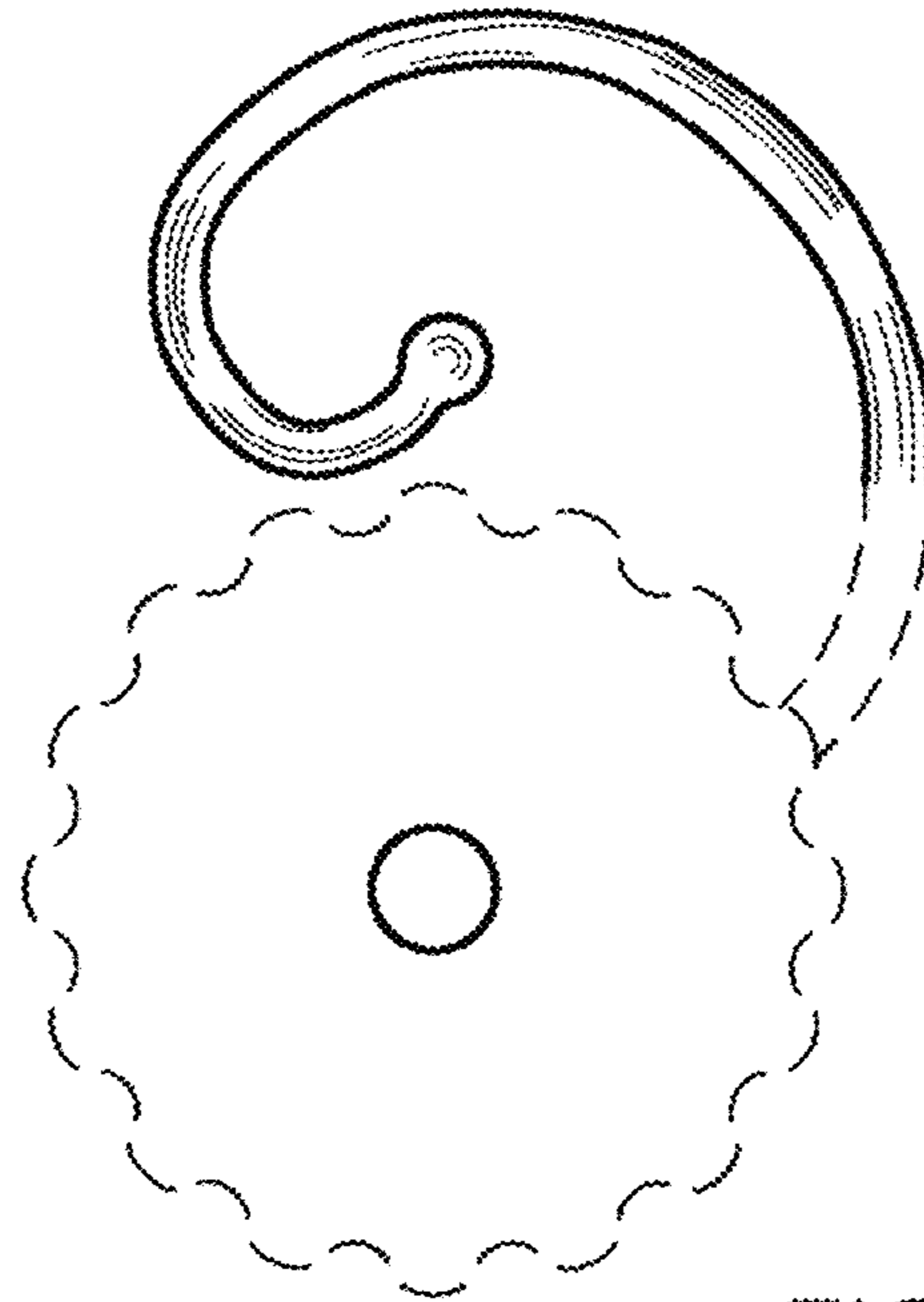

FIG. 8

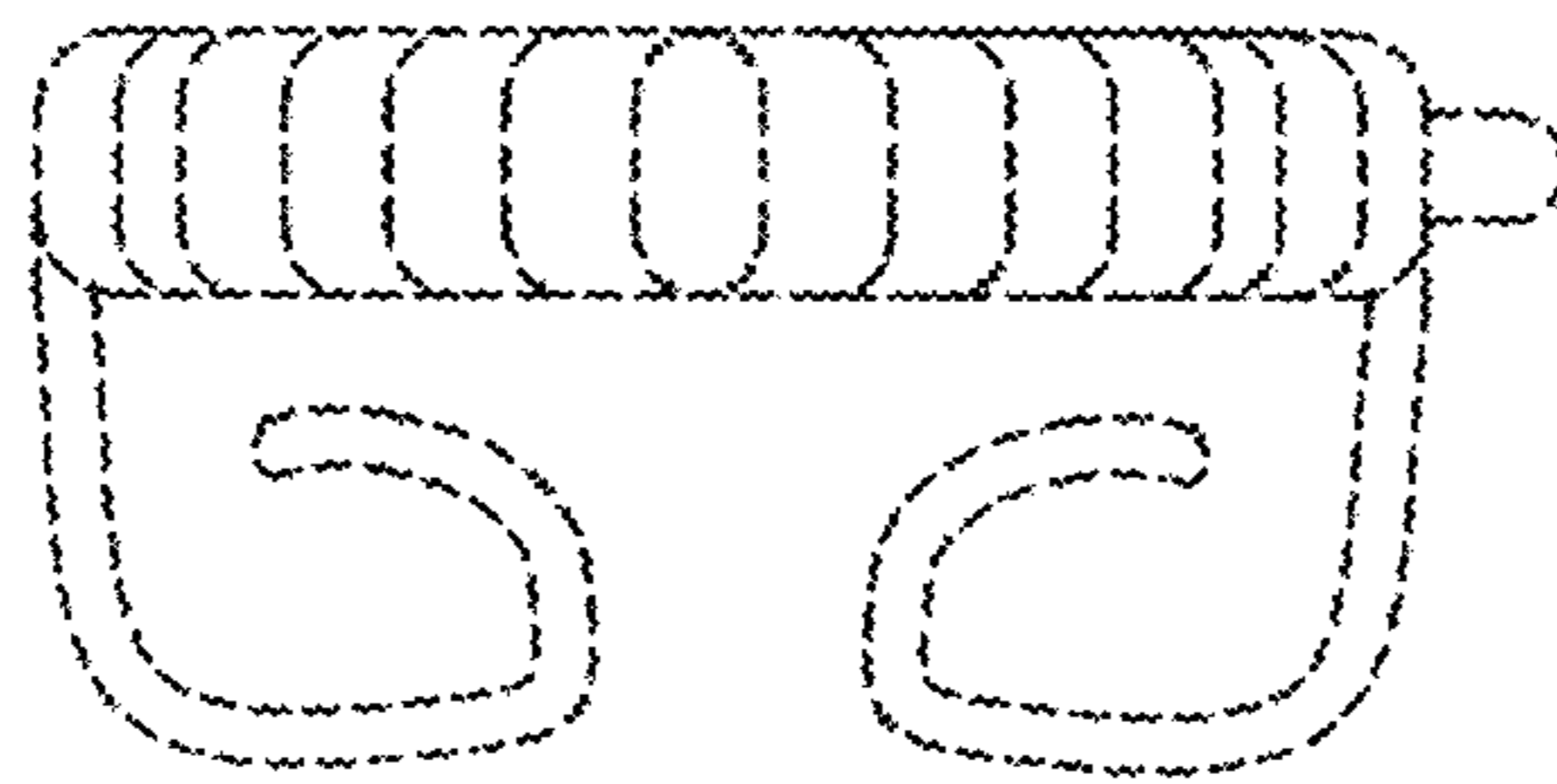

FIG. 10

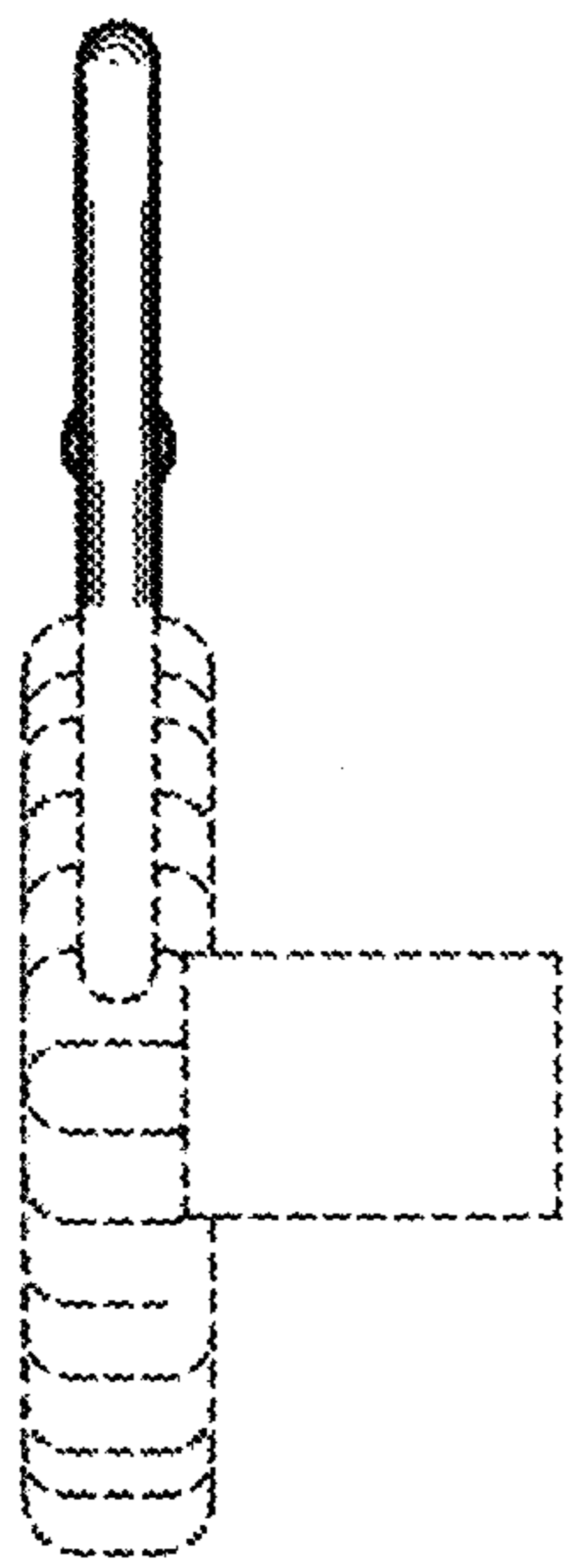

FIG. 12

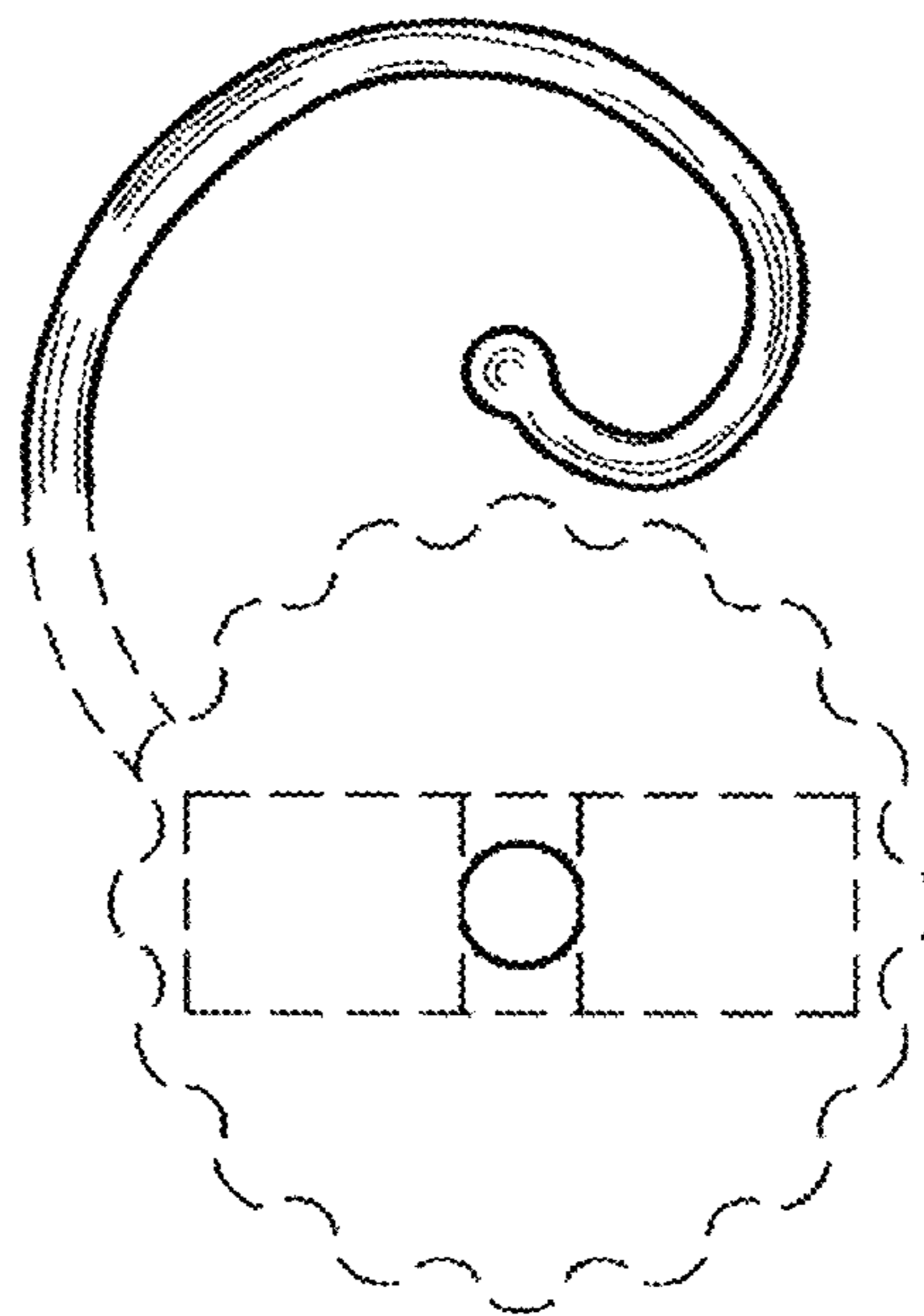

FIG. 11

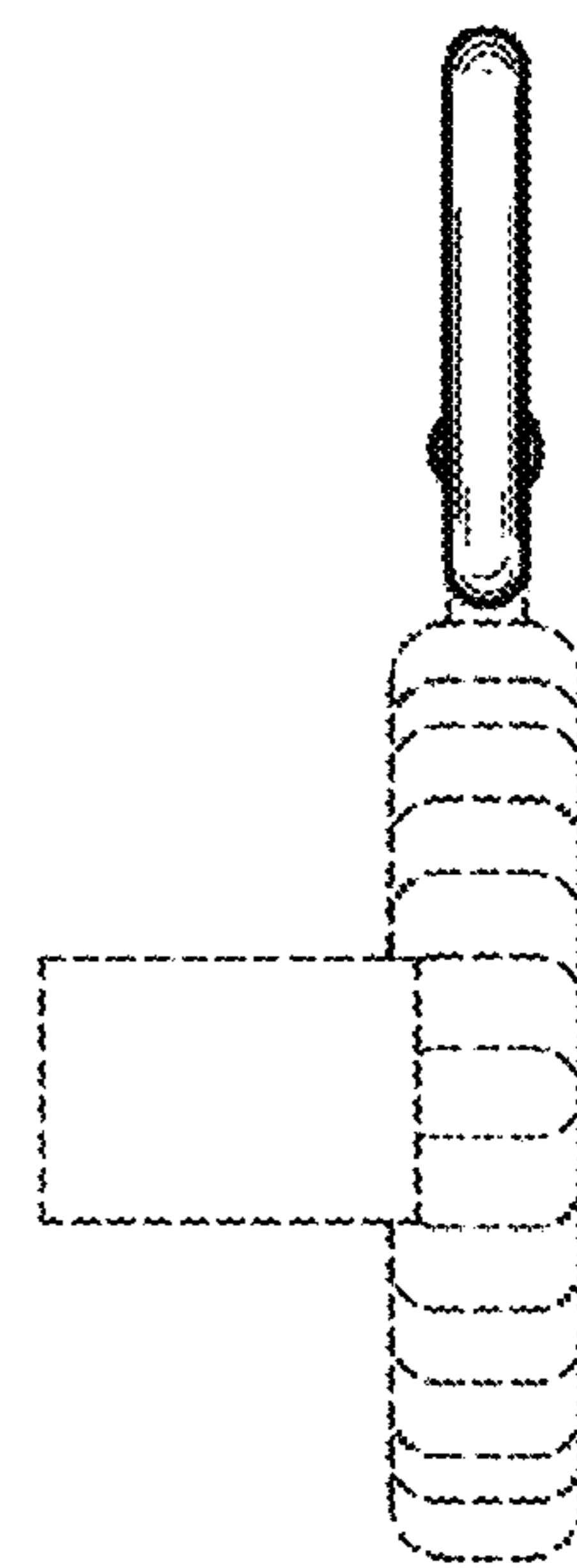

FIG. 13

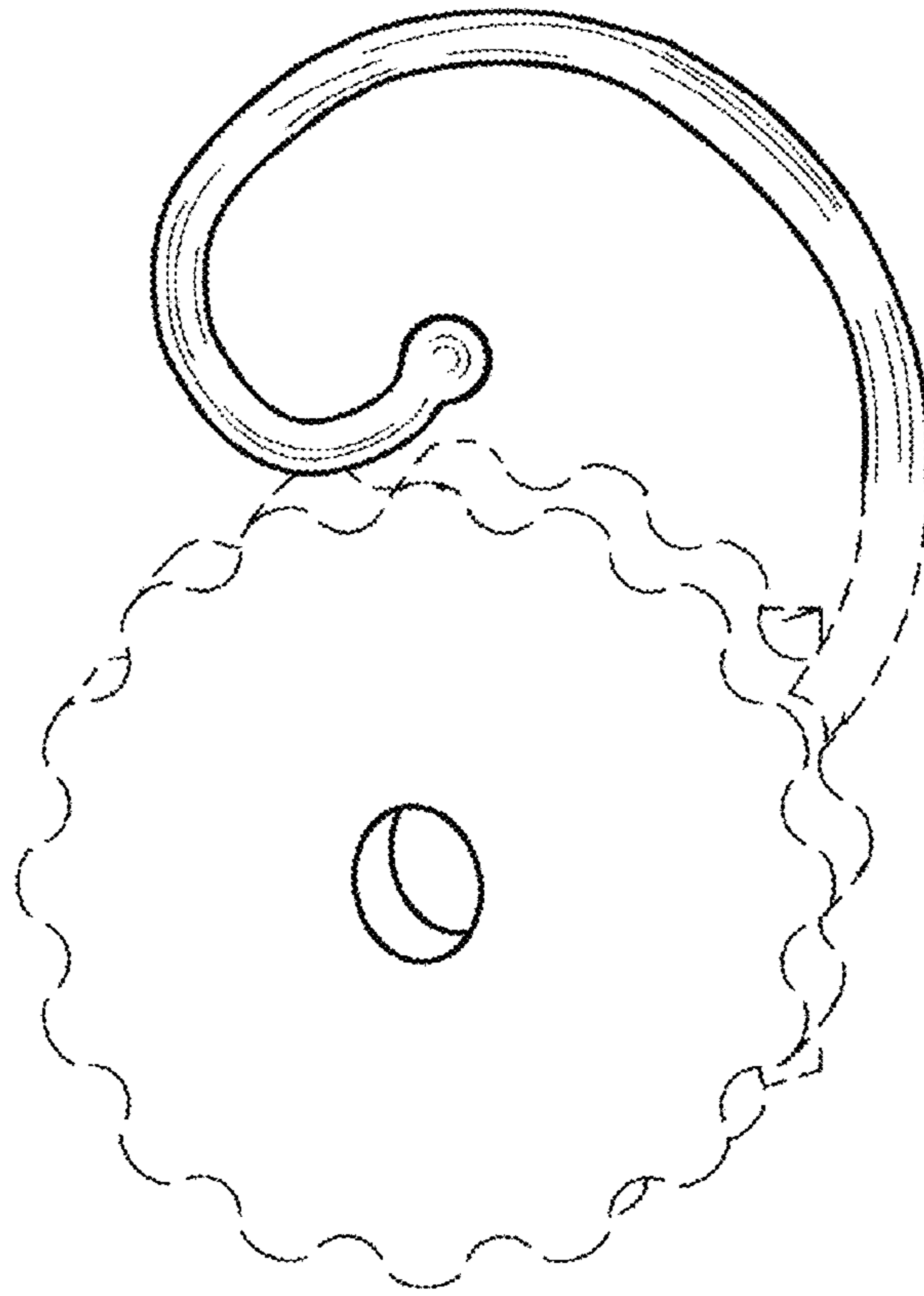

FIG.14