



US00D727714S

(12) **United States Design Patent**
Gherlenda

(10) **Patent No.:** **US D727,714 S**

(45) **Date of Patent:** **** Apr. 28, 2015**

(54) **ACTUATOR FOR GATES AND DOORS**

(71) Applicant: **NICE S.p.A.**, Oderzo (TV) (IT)

(72) Inventor: **Roberto Gherlenda**, Oderzo (IT)

(73) Assignee: **NICE S.p.A.**, Oderzo (TV) (IT)

(**) Term: **14 Years**

(21) Appl. No.: **29/469,453**

(22) Filed: **Oct. 10, 2013**

(30) **Foreign Application Priority Data**

Apr. 12, 2013 (EM) 002219410-0001

(51) **LOC (10) Cl.** **08-07**

(52) **U.S. Cl.**
USPC **D8/331; D8/336; D8/339**

(58) **Field of Classification Search**
USPC D8/330, 331, 336, 338, 339, 341, 344,
D8/349, 323; 70/57, 57.1, 266, 431;
292/92, 289, 290, DIG. 29; 16/86.1,
16/86.2, 239; 49/208, 236, 246, 9, 141,
49/135, 324, 334, 340; 160/368.1
See application file for complete search history.

(56) **References Cited**

U.S. PATENT DOCUMENTS

4,330,958 A * 5/1982 Richmond 49/280
5,271,426 A * 12/1993 Clarkson et al. 137/375

D365,268 S * 12/1995 Wostyn D8/331
5,867,939 A * 2/1999 Merrill 49/340
6,408,571 B1 * 6/2002 Trott 49/263
6,470,626 B2 * 10/2002 Luetzow et al. 49/9
6,651,386 B2 * 11/2003 Long 49/141
6,672,008 B1 * 1/2004 Luetzow et al. 49/9
6,748,848 B1 * 6/2004 Riley et al. 92/103 R
7,367,161 B1 * 5/2008 Jones 49/334
D614,014 S * 4/2010 Bo D8/331
D655,997 S * 3/2012 Merget D8/339
8,240,618 B1 * 8/2012 Luetzow 246/111

* cited by examiner

Primary Examiner — Prabhakar Deshmukh

(74) *Attorney, Agent, or Firm* — Novak Druce Connolly
Bove + Quigg LLP

(57) **CLAIM**

The ornamental design for an actuator for gates and doors, as shown and described.

DESCRIPTION

FIG. 1 is a perspective view of an actuator for gates and doors showing my new design;
FIG. 2 is another perspective view thereof;
FIG. 3 is a front view thereof;
FIG. 4 is a rear view thereof;
FIG. 5 is a side view thereof;
FIG. 6 is a top view thereof; and,
FIG. 7 is a bottom view thereof.
The broken lines indicate unclaimed portions and form no part of the claimed design.

1 Claim, 7 Drawing Sheets

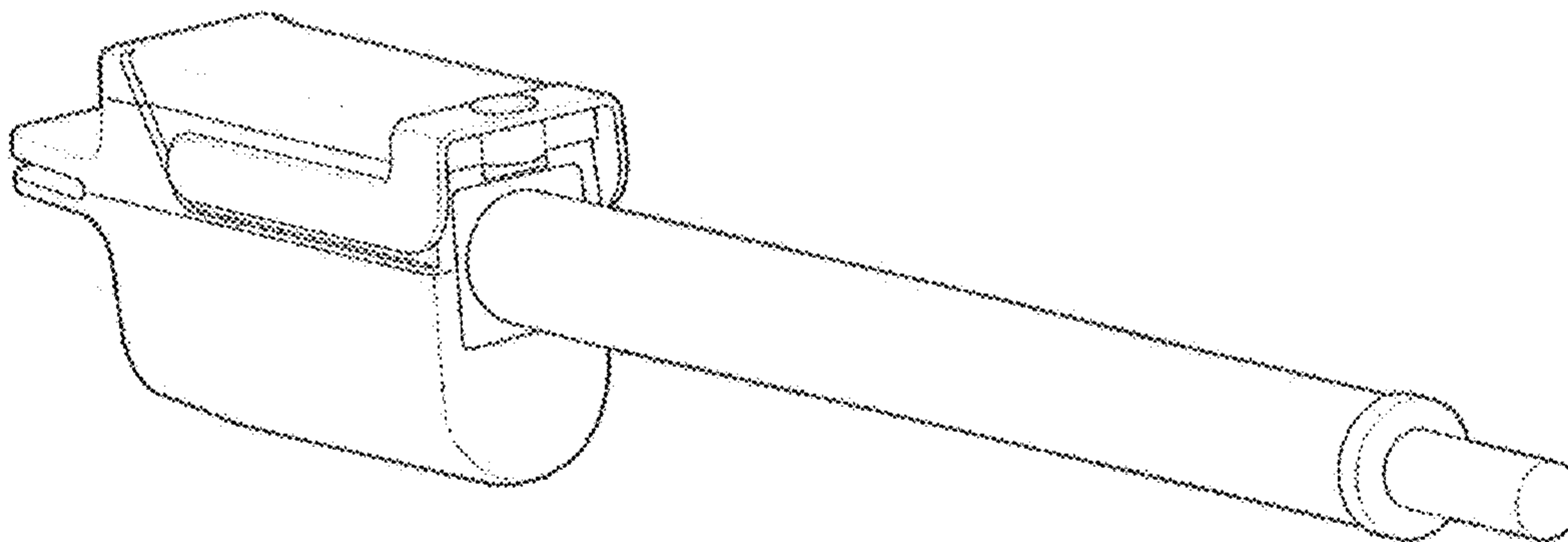

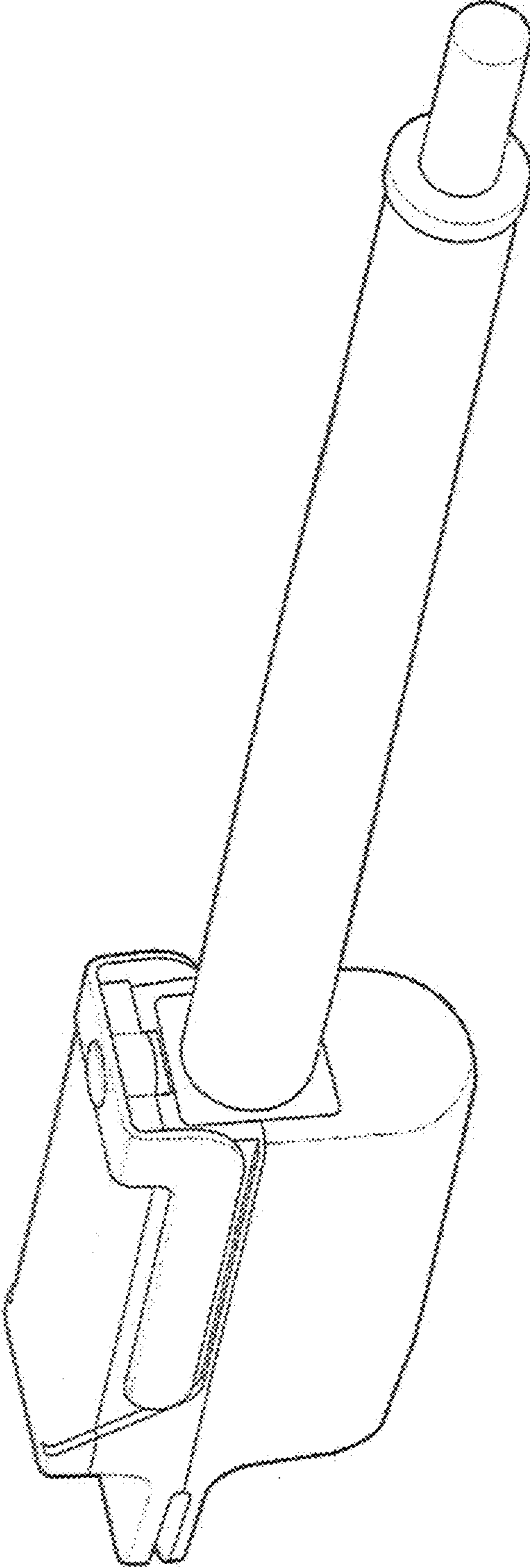

FIG. 1

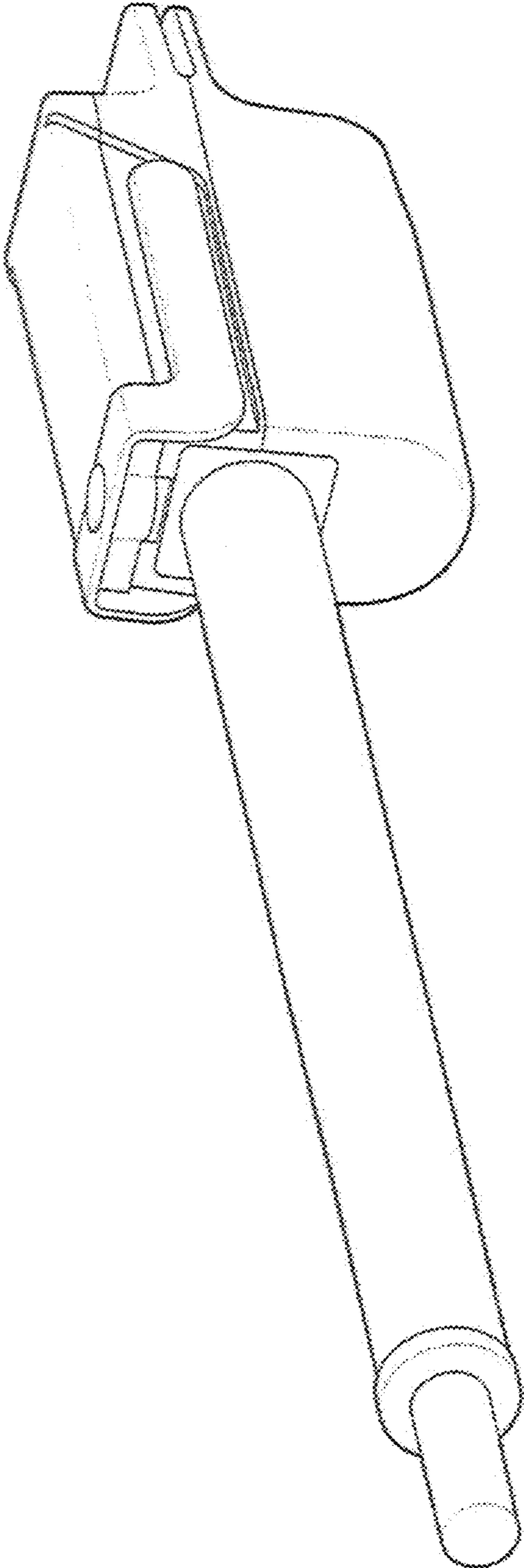

FIG. 2

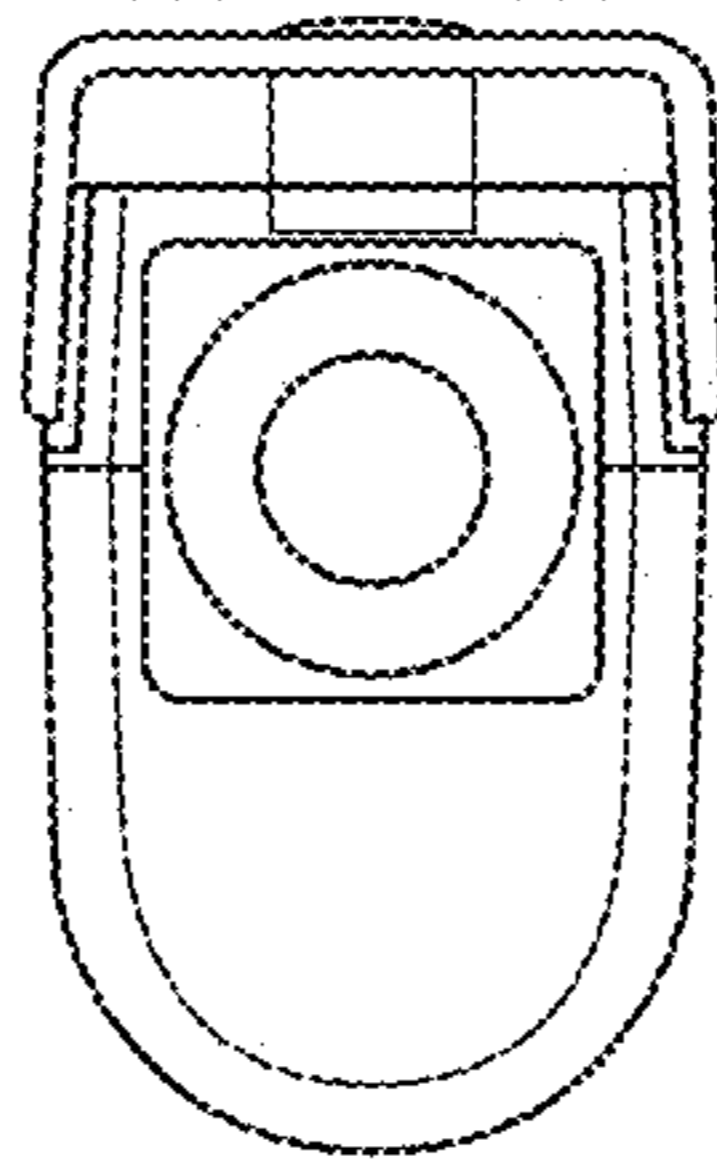

FIG. 3

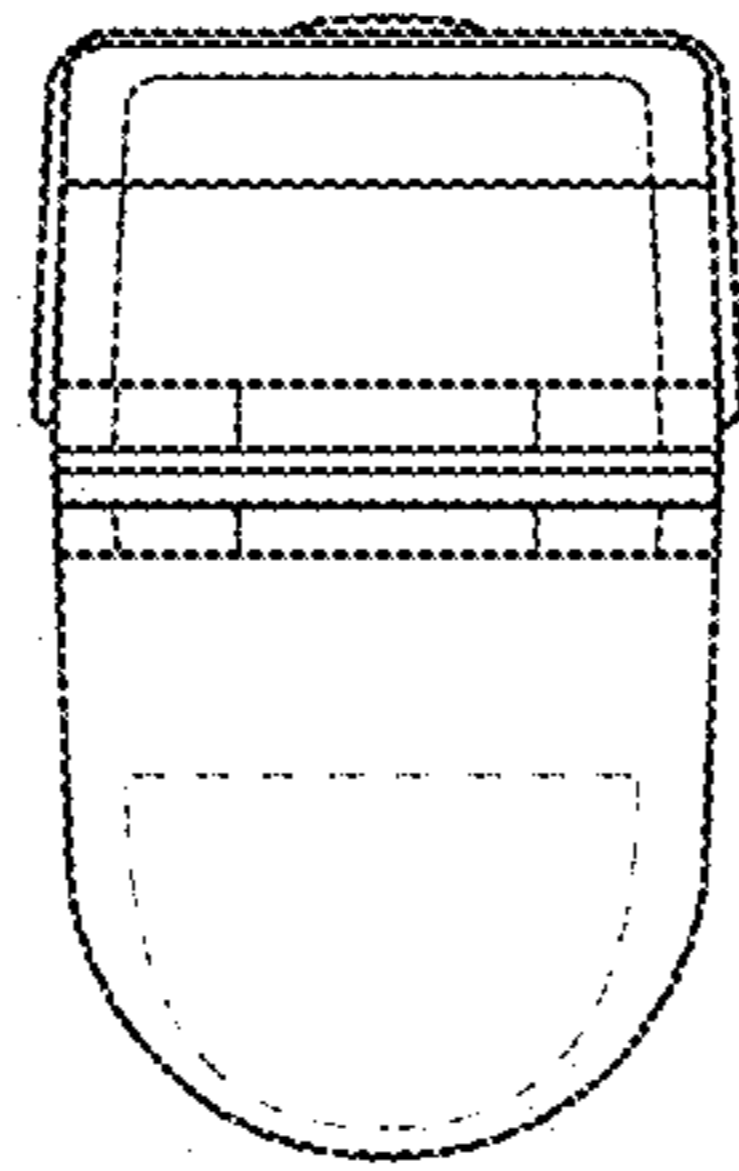

FIG. 4

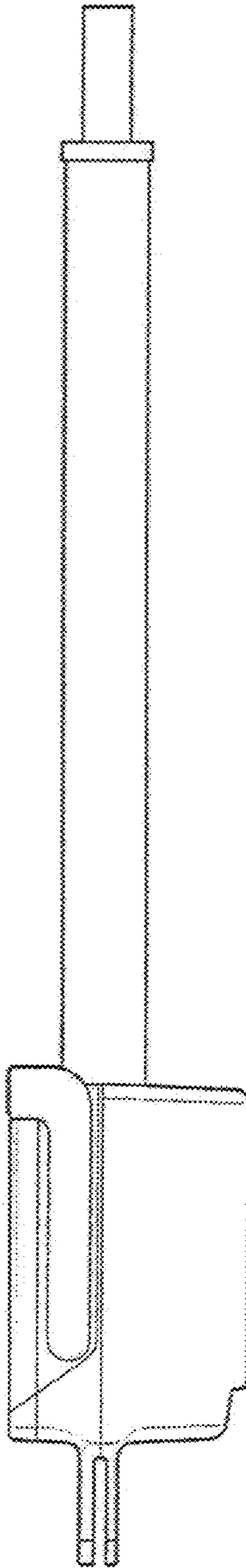

FIG. 5

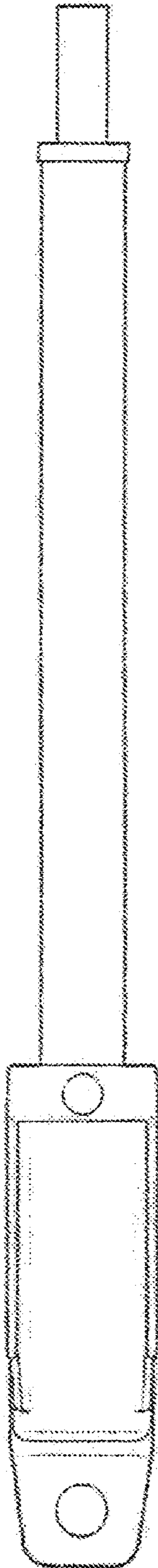

FIG. 6

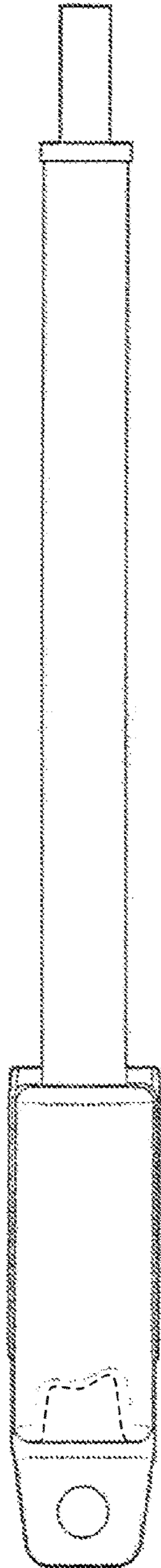

FIG. 7