



US00D727676S

(12) **United States Design Patent**
Barford

(10) **Patent No.:** **US D727,676 S**
(45) **Date of Patent:** **** Apr. 28, 2015**

(54) **COOKING STOVE**

(71) Applicant: **Standard Brands (UK) Limited**,
Leatherhead, Surrey (GB)

(72) Inventor: **Eric Dennis Barford**, Castlebellingham
(IE)

(73) Assignee: **Standard Brands (UK) Limited**,
Leatherhead, Surrey (GB)

(**) Term: **14 Years**

(21) Appl. No.: **29/481,497**

(22) Filed: **Feb. 6, 2014**

(51) **LOC (10) Cl.** **07-02**

(52) **U.S. Cl.**
USPC **D7/332**

(58) **Field of Classification Search**
USPC D7/332, 335-337, 402-403, 405, 543,
D7/547, 548, 354, 361, 533; 126/25 R,
126/29-30, 9 R, 9 B, 38, 40, 50, 41 R,
126/43-44; 99/450

See application file for complete search history.

(56) **References Cited**

U.S. PATENT DOCUMENTS

3,589,353	A	6/1971	Sanders	
3,682,154	A	8/1972	Mollere	
4,126,116	A *	11/1978	McCallum	126/9 R
4,726,349	A *	2/1988	Gehrke	126/25 R
6,425,387	B1 *	7/2002	Rohback, Jr.	126/9 R
D468,959	S *	1/2003	Rohback, Jr.	D7/402
D498,976	S *	11/2004	Schulte et al.	D7/402
D546,114	S *	7/2007	Reiner	D7/332
D615,354	S *	5/2010	Garpelin	D7/402
D644,474	S *	9/2011	Wilgus et al.	D7/332
8,028,689	B2 *	10/2011	Bruno	126/25 R
D658,438	S *	5/2012	Zandbergen et al.	D7/402
D682,006	S *	5/2013	Merkurieff	D7/332
D693,621	S *	11/2013	Weyandt	D7/332
D693,622	S *	11/2013	Weyandt	D7/332

D693,623 S * 11/2013 Merkurieff D7/332
2004/0020484 A1 * 2/2004 Skidmore et al. 126/25 R
2004/0250807 A1 12/2004 Reiner

(Continued)

FOREIGN PATENT DOCUMENTS

CH 706414 A1 10/2013
GB 2247748 A 3/1992

OTHER PUBLICATIONS

International Search Report for PCT/GB2014/050352 dated Sep. 29,
2014, 5 pages.

Primary Examiner — Ruth McInroy

(74) *Attorney, Agent, or Firm* — Banner & Witcoff, Ltd.

(57) **CLAIM**

The ornamental design for a cooking stove, as shown and
described.

DESCRIPTION

FIG. 1 is a front perspective view of a cooking stove showing
my new design in a collapsed position;
FIG. 2 is a front view thereof;
FIG. 3 is a rear view thereof;
FIG. 4 is a left side view thereof;
FIG. 5 is a right side view thereof;
FIG. 6 is a top view thereof;
FIG. 7 is a bottom view thereof;
FIG. 8 is a rear perspective view thereof;
FIG. 9 is a front perspective view thereof, in an expanded
position;
FIG. 10 is a front view thereof;
FIG. 11 is a rear view thereof;
FIG. 12 is a left side view thereof;
FIG. 13 is a right side view thereof;
FIG. 14 is a top view thereof;
FIG. 15 is a bottom view thereof; and,
FIG. 16 is a rear perspective view thereof.

1 Claim, 9 Drawing Sheets

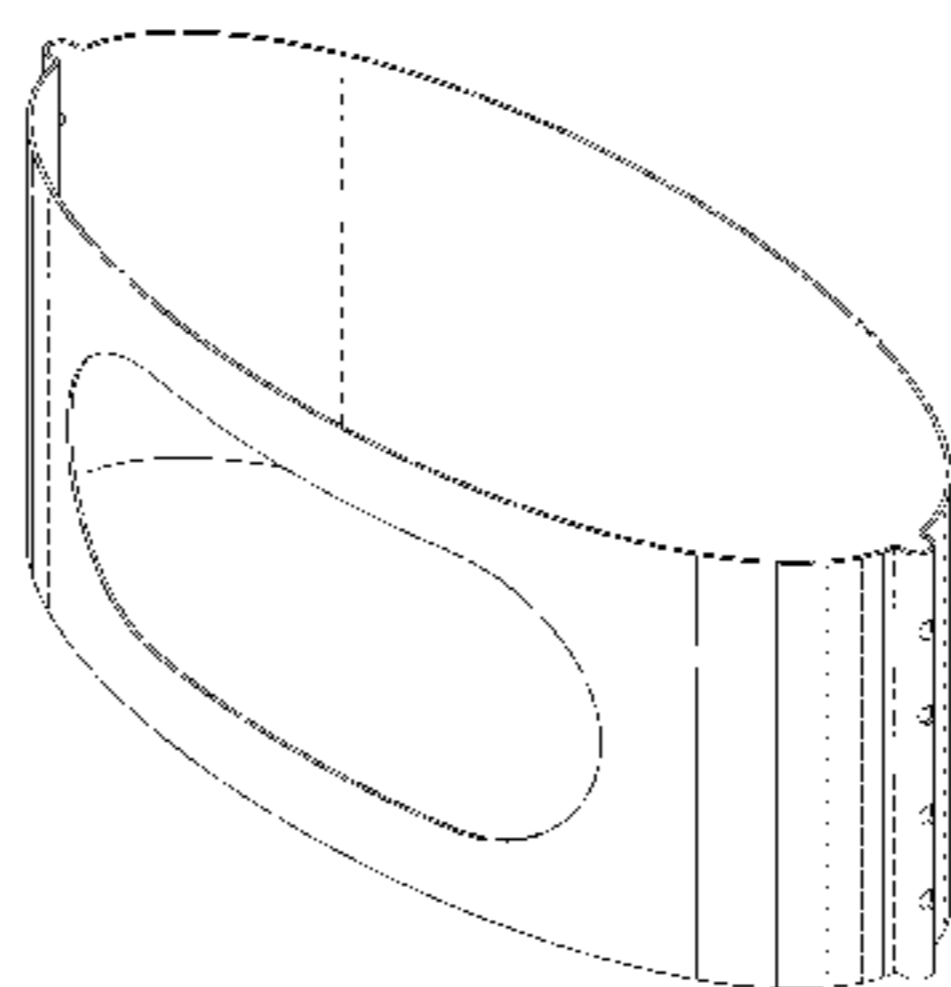
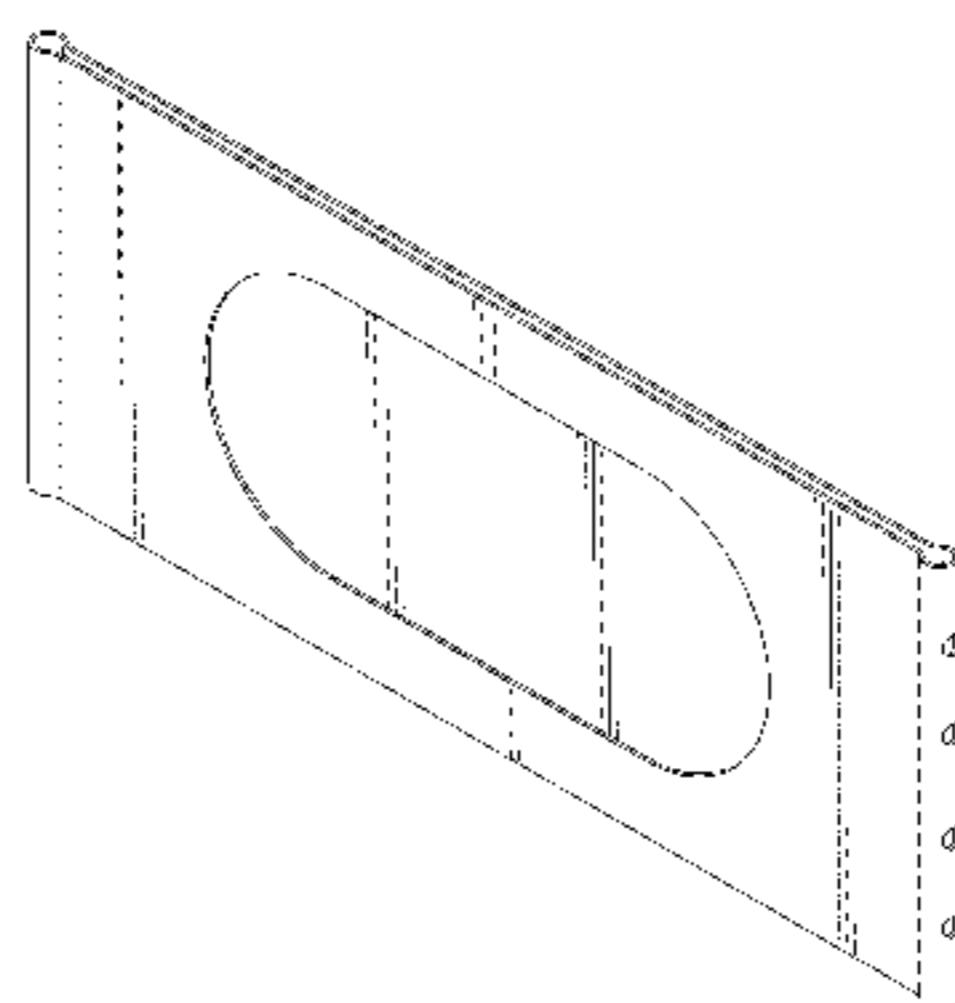

(56)

References Cited

U.S. PATENT DOCUMENTS

2005/0115556	A1*	6/2005	Carson et al.	126/25 R	2010/0288261	A1*	11/2010	Jones	126/25 R
2009/0205627	A1	8/2009	Timmons et al.		2012/0260904	A1*	10/2012	Russell	126/25 R
2009/0301470	A1*	12/2009	Ellis	126/9 R	2013/0180515	A1*	7/2013	Zandbergen et al.	126/25 R
					2013/0220313	A1	8/2013	Ellis	

* cited by examiner

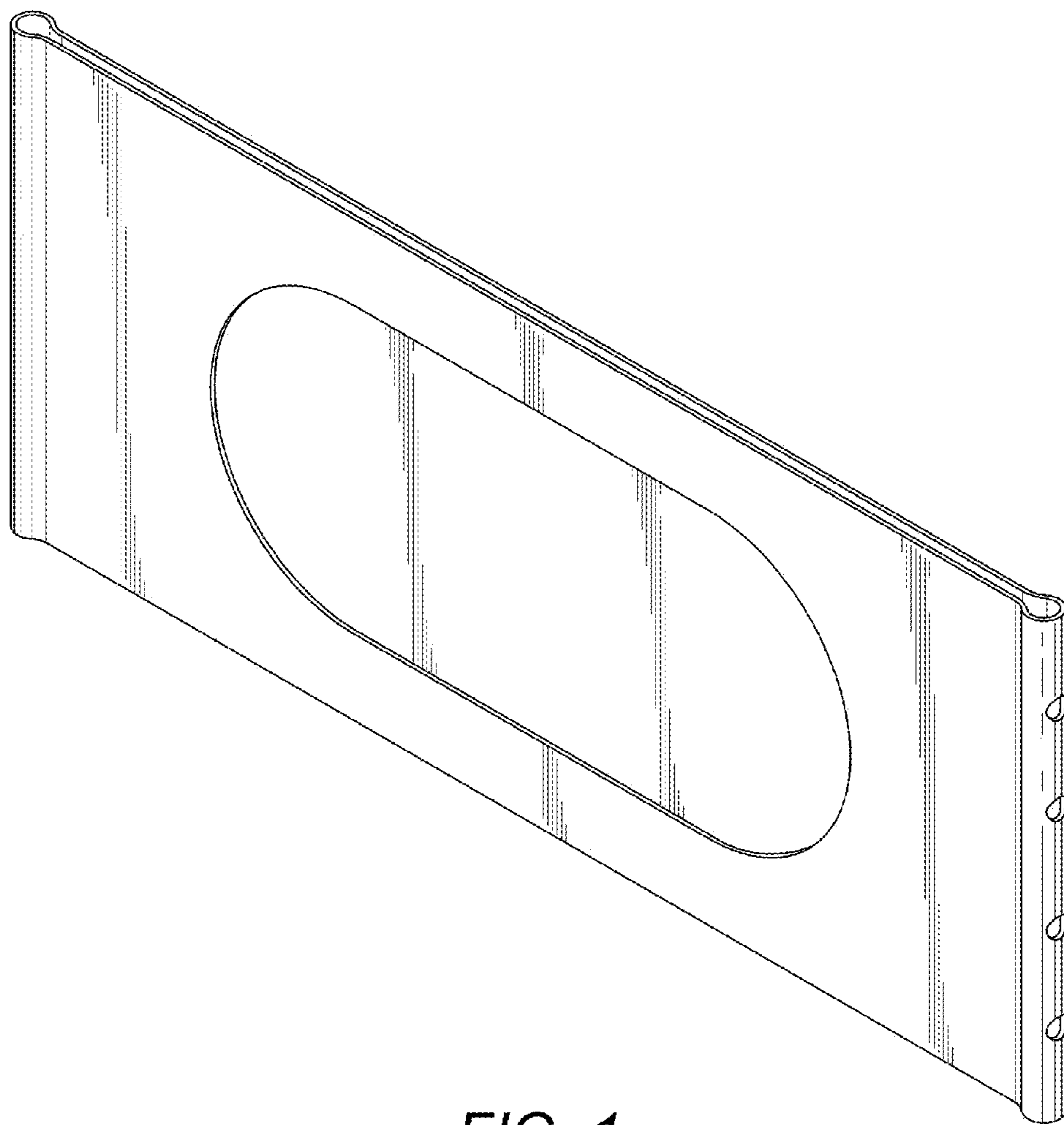

FIG. 1

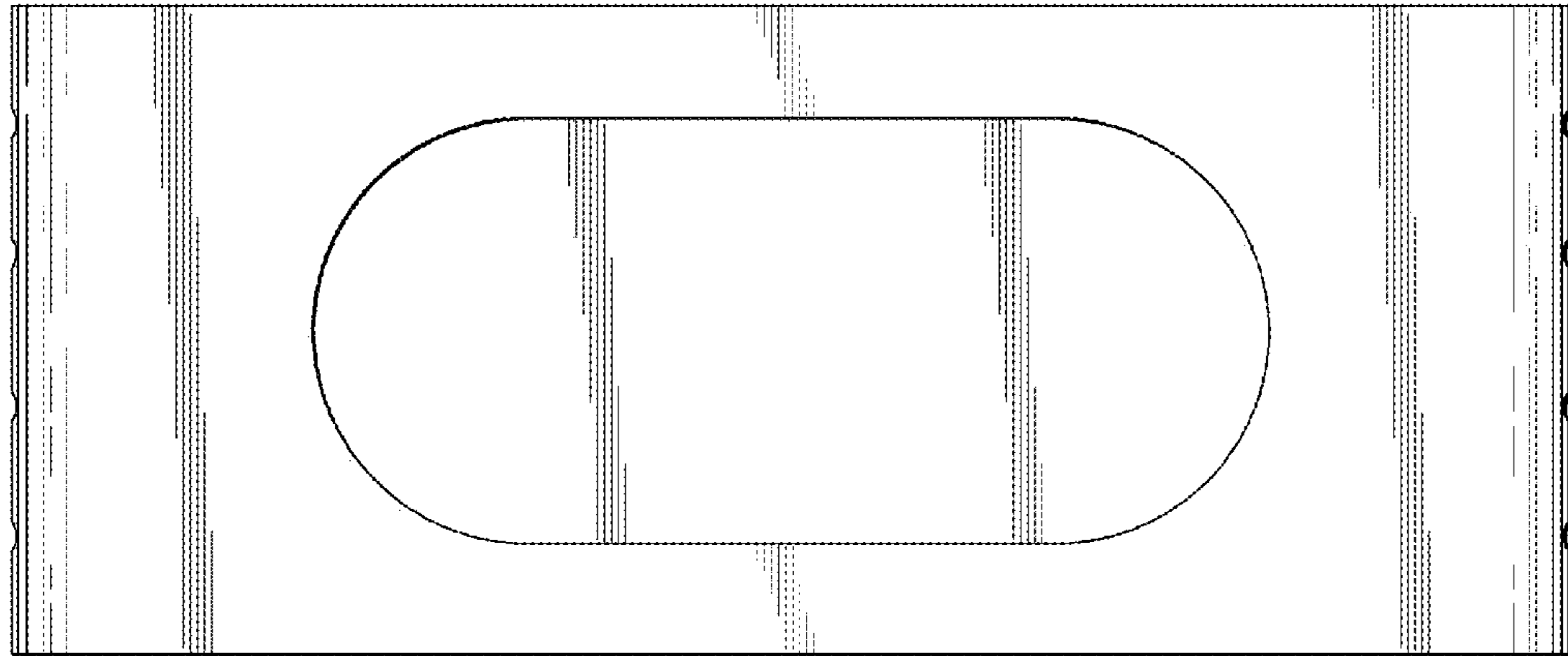

FIG. 2

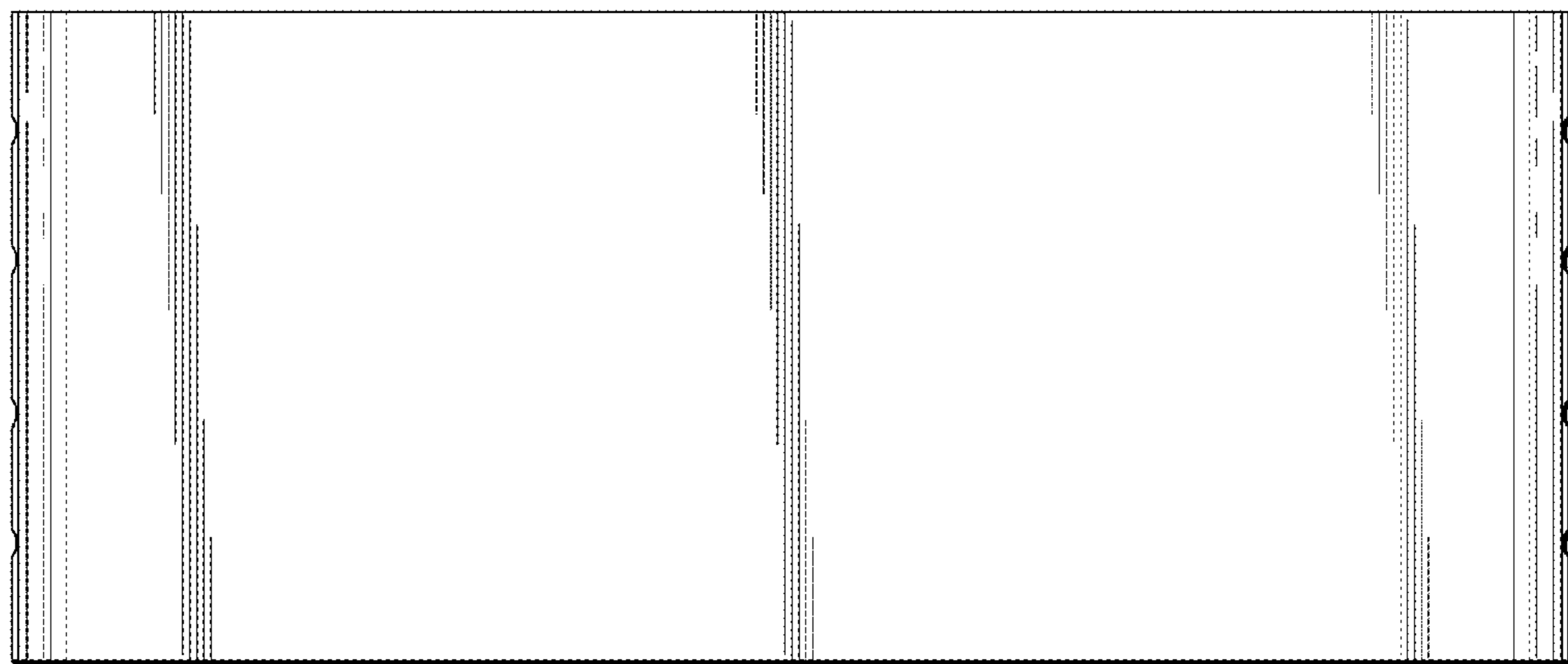

FIG. 3

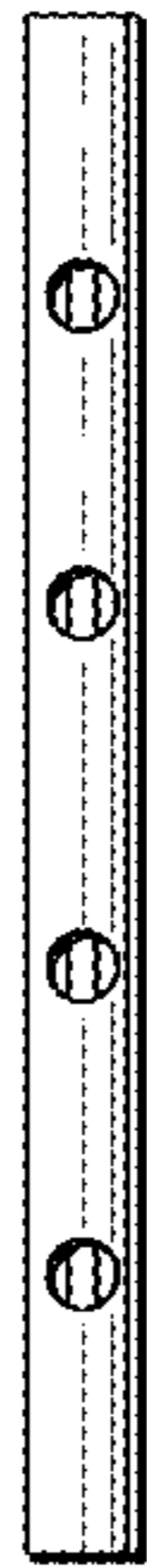

FIG. 4

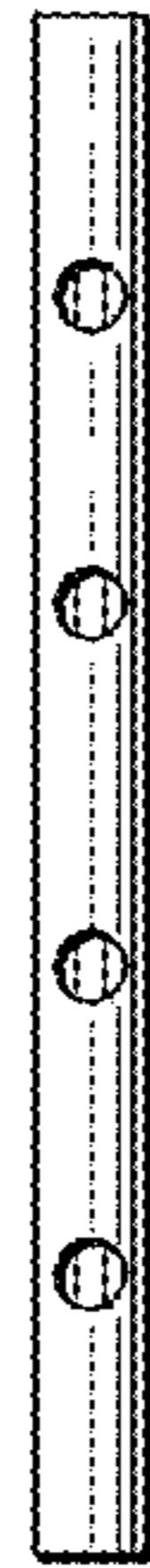

FIG. 5



FIG. 6

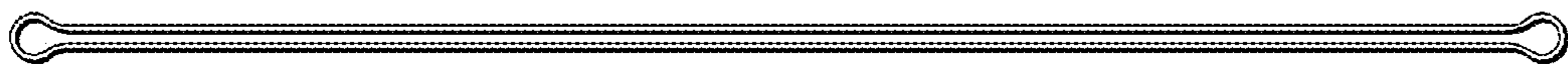

FIG. 7

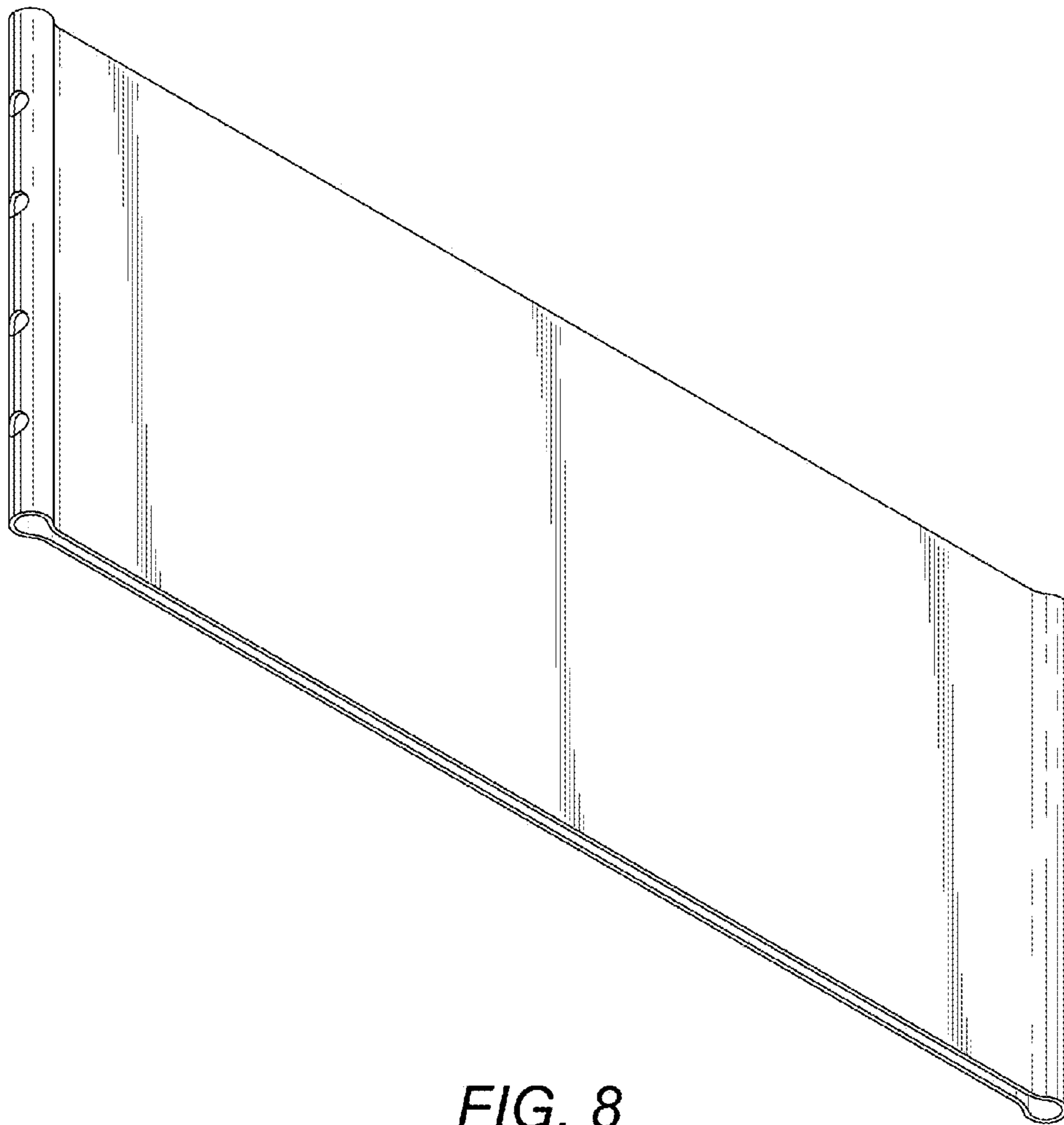

FIG. 8

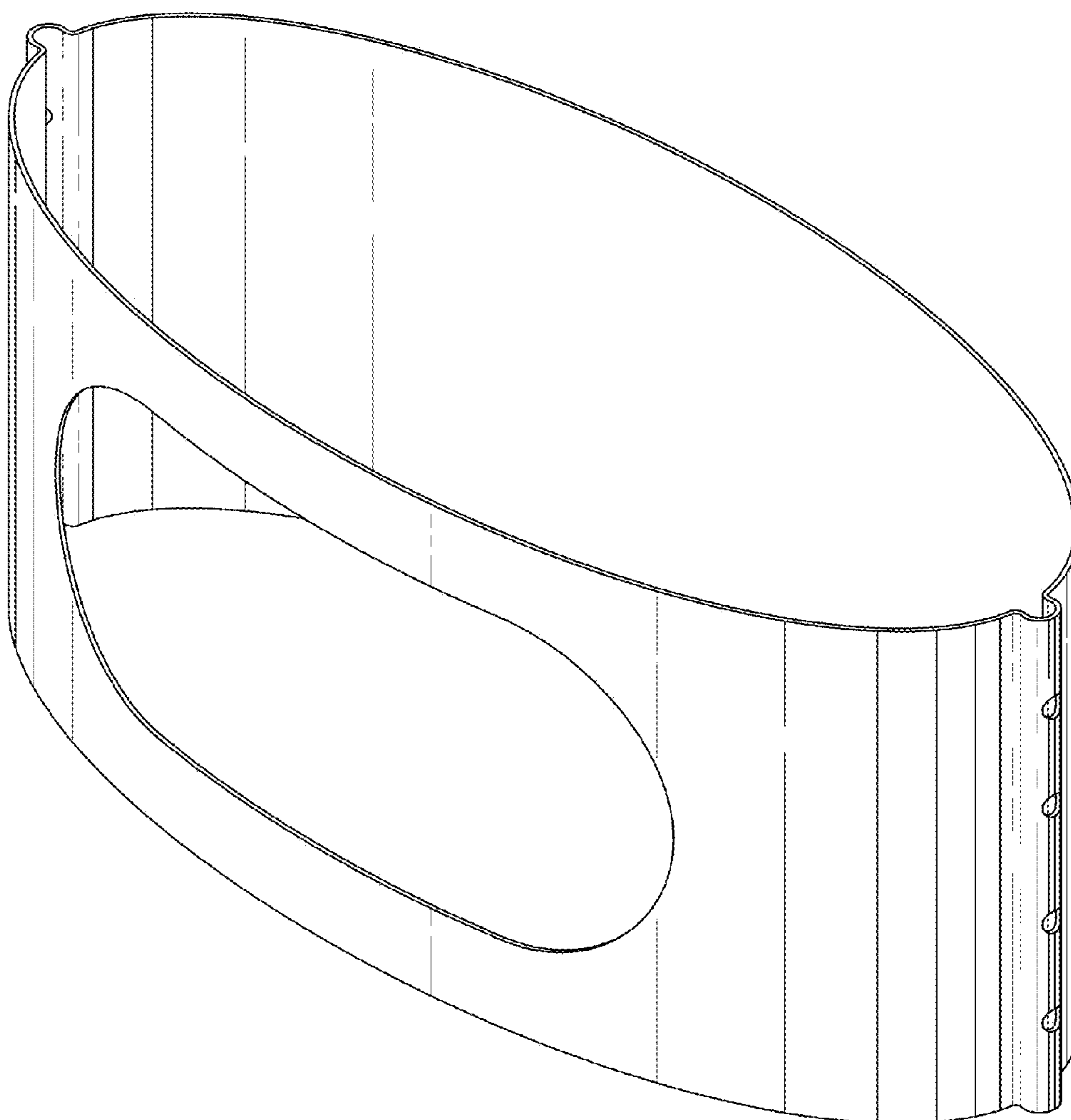

FIG. 9

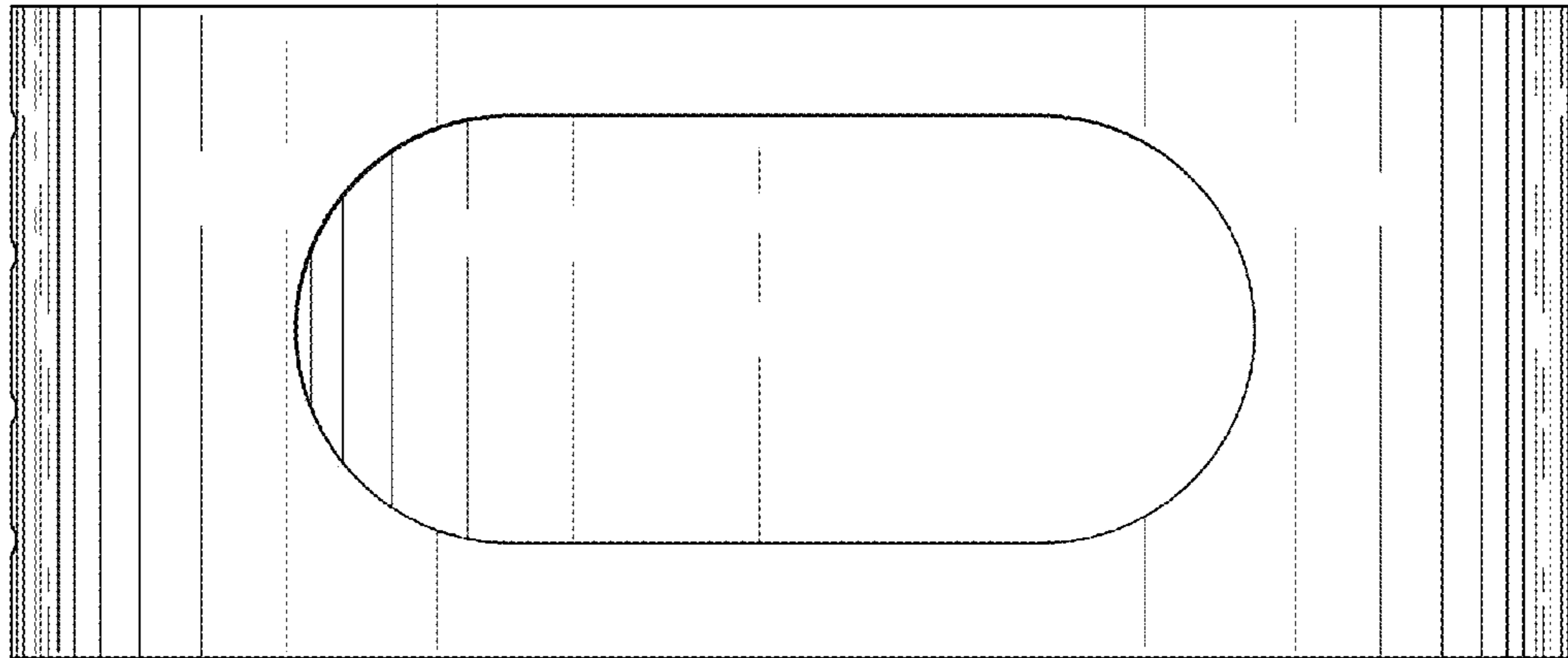

FIG. 10

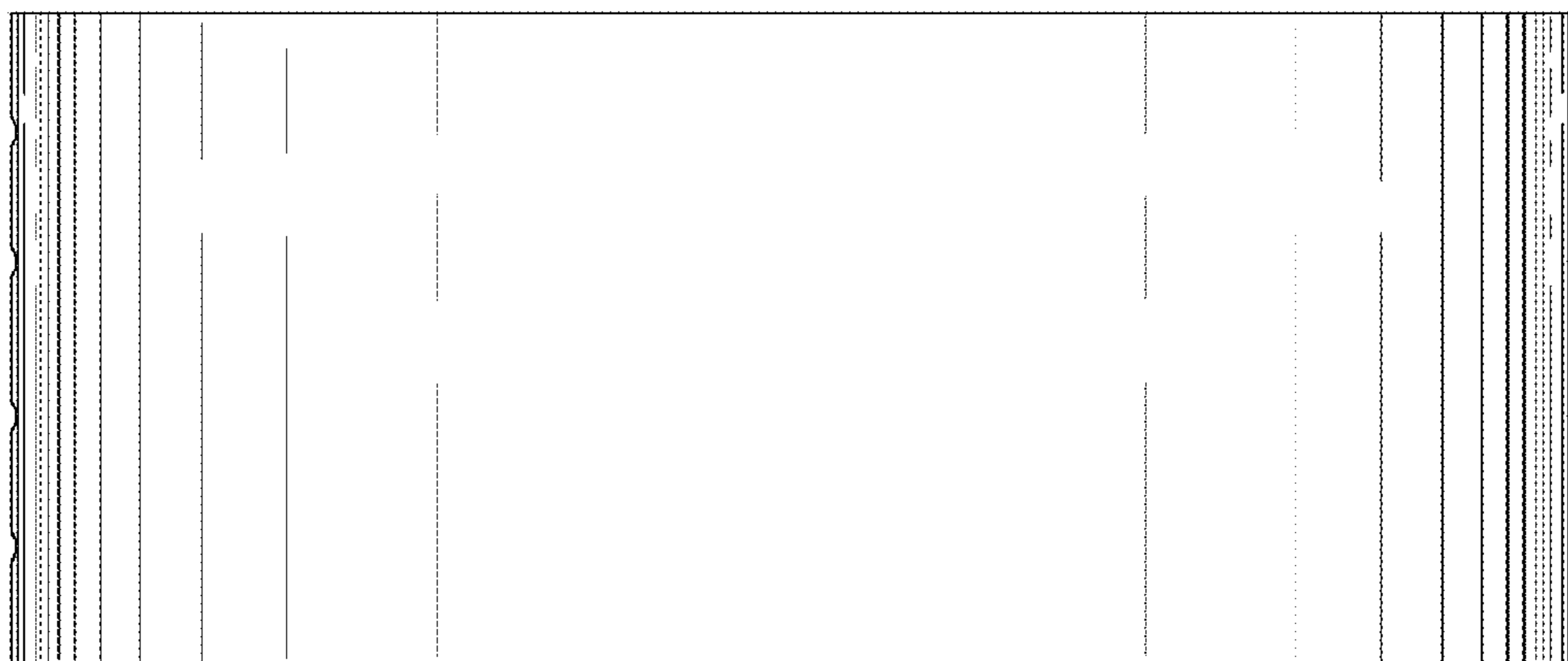

FIG. 11

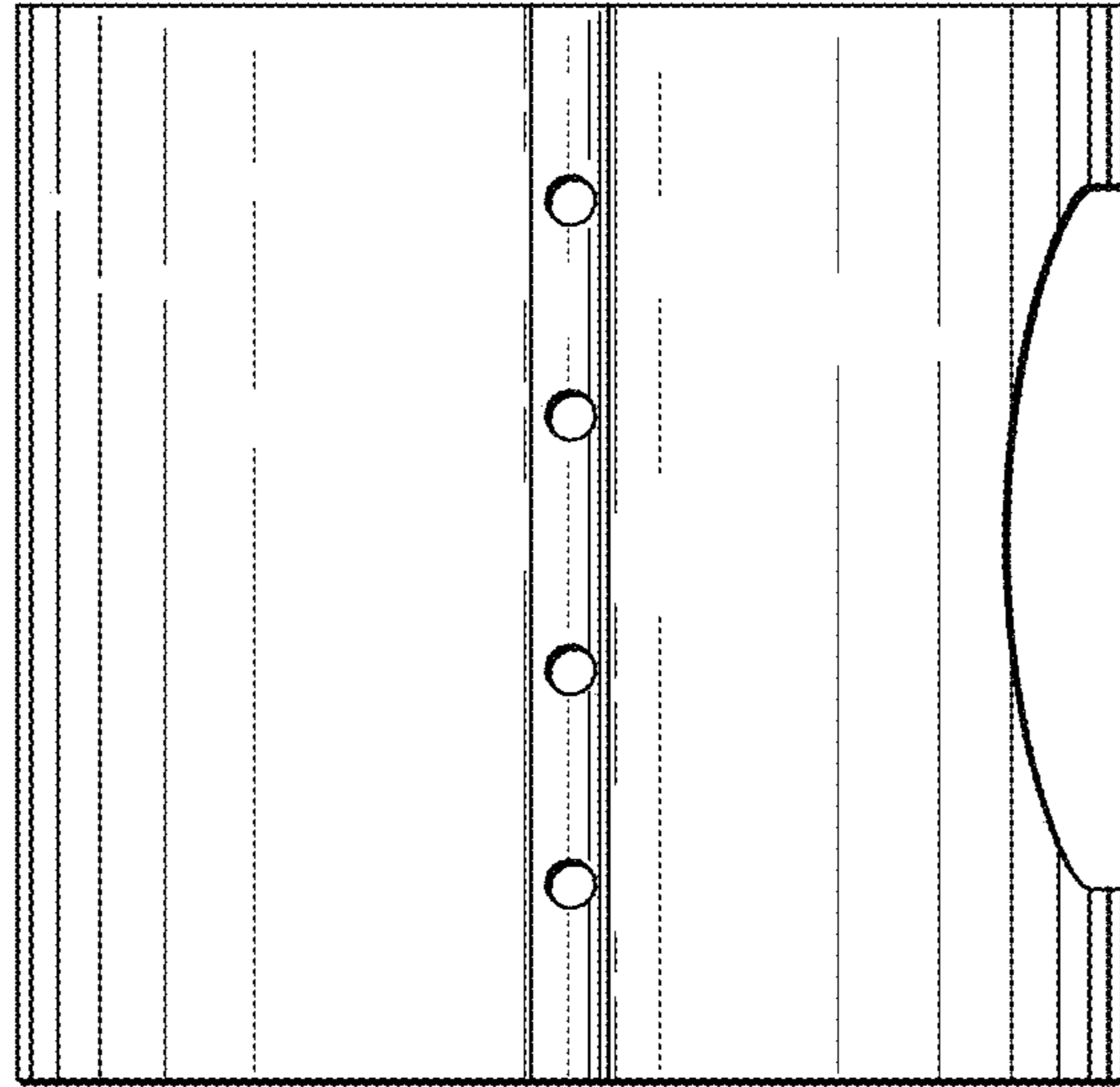

FIG. 12

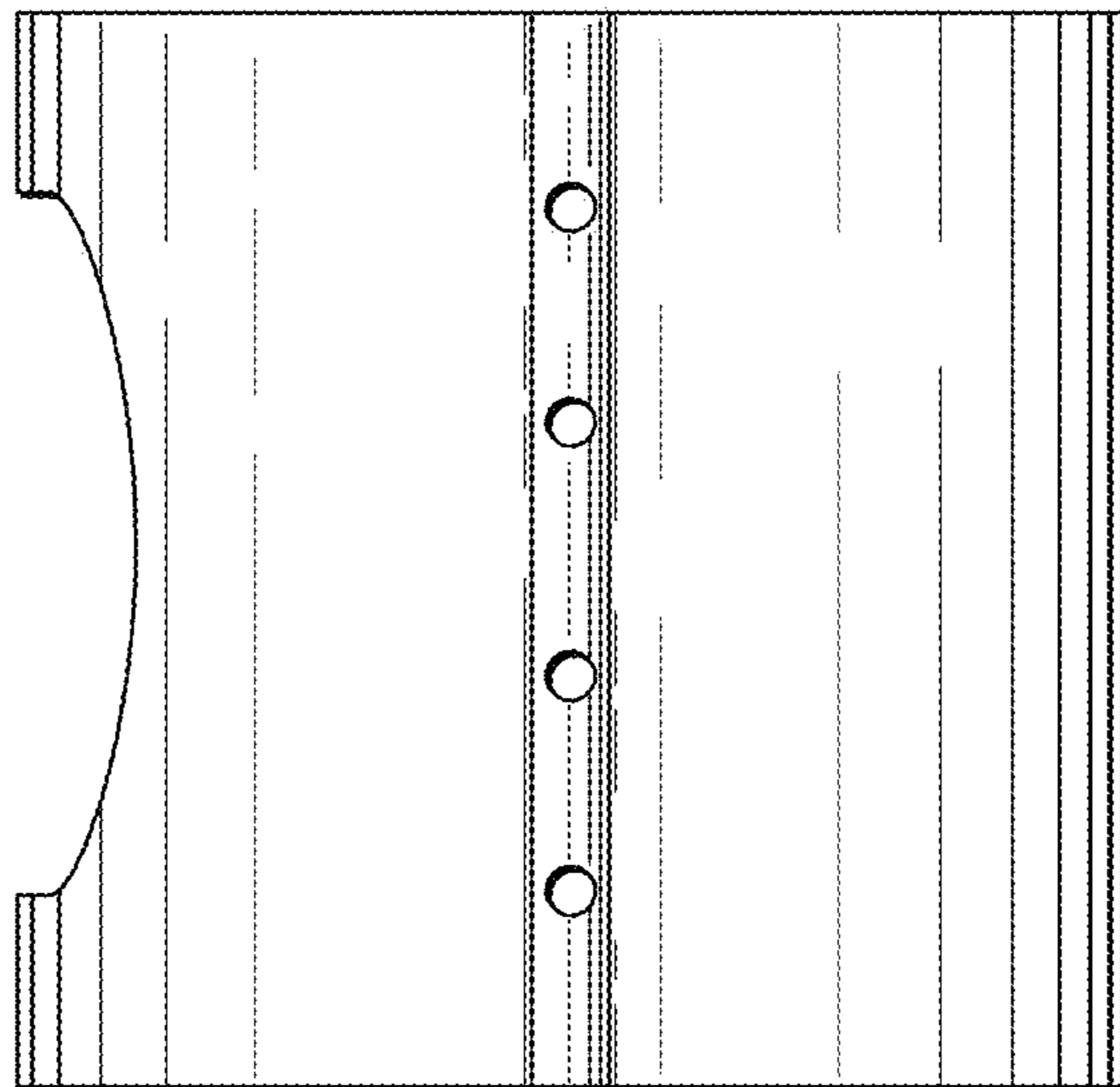

FIG. 13

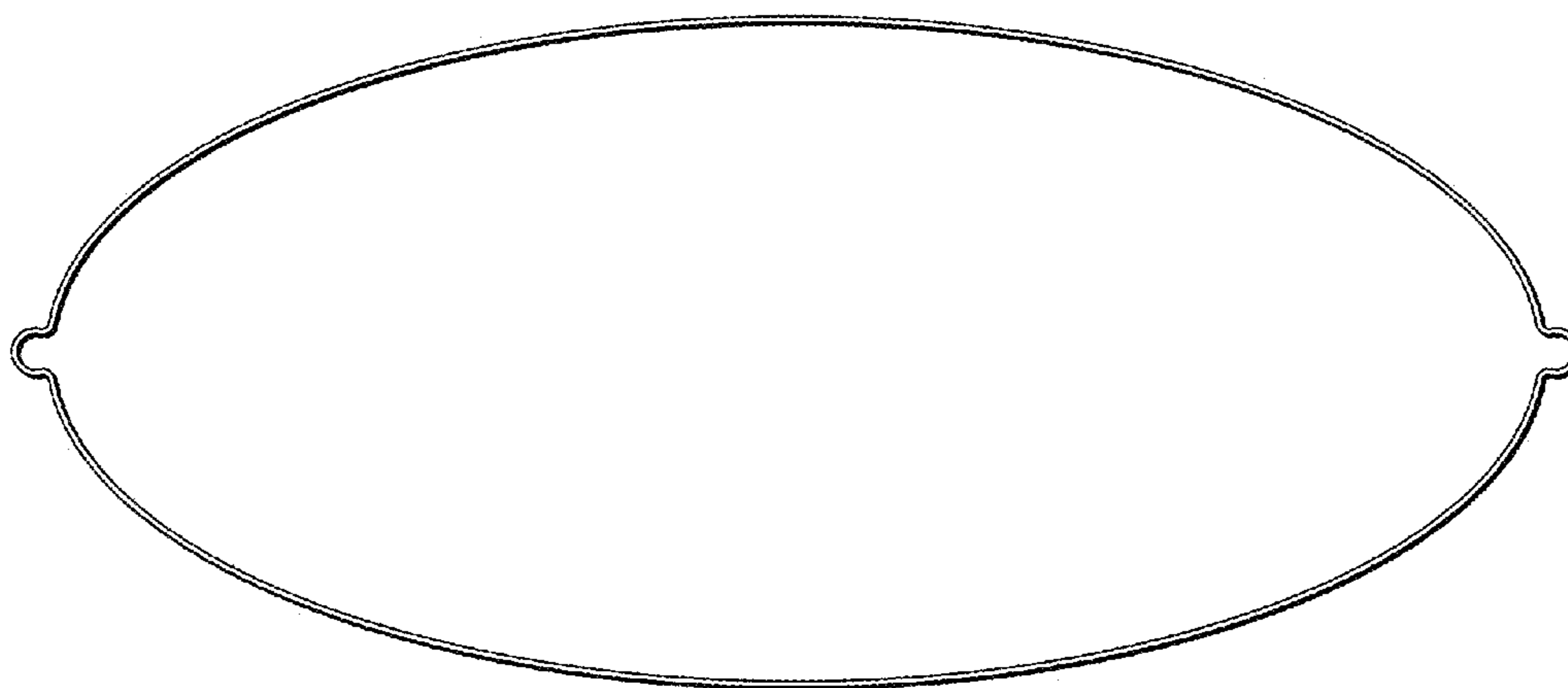

FIG. 14

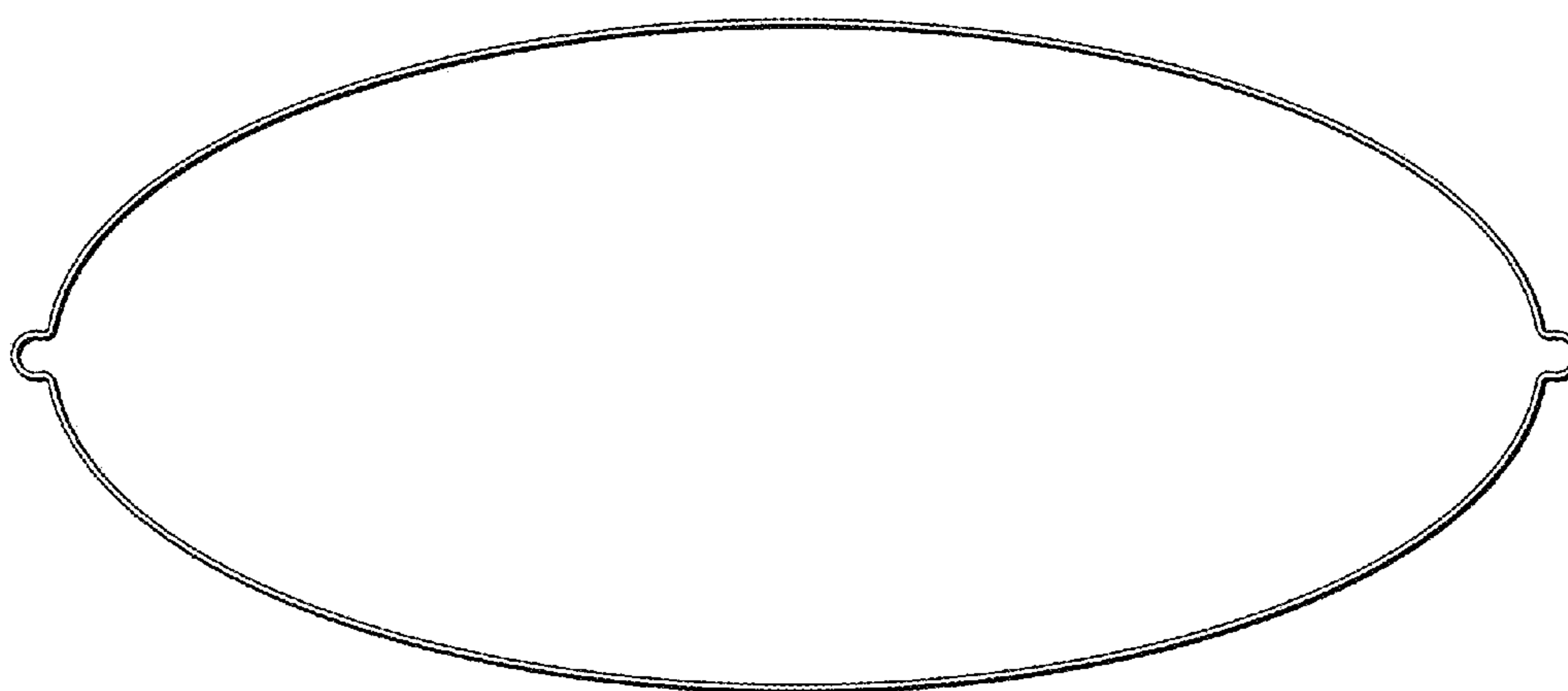

FIG. 15

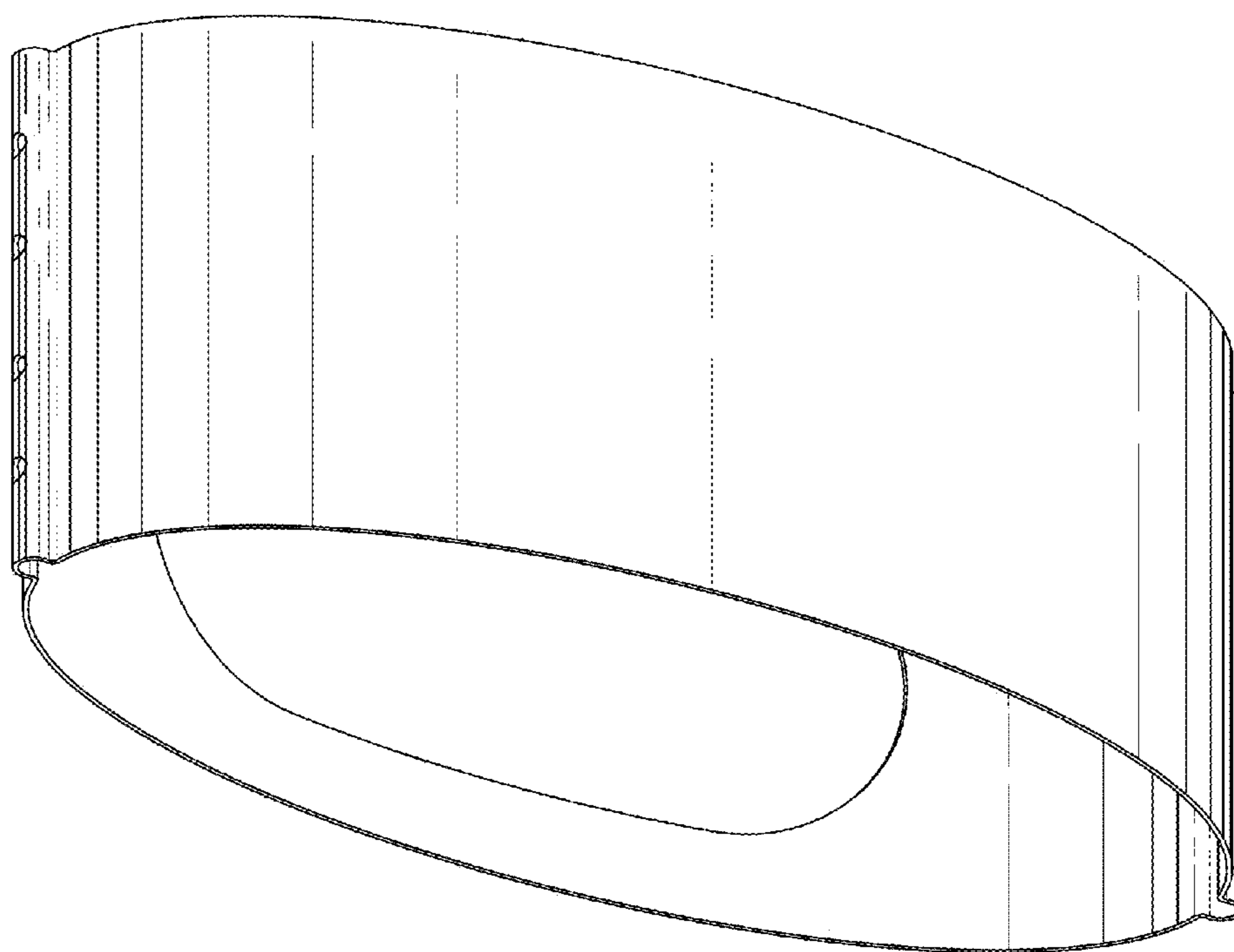

FIG. 16