

US00D727670S

(12) **United States Design Patent**
Rokos

(10) **Patent No.:** **US D727,670 S**
(45) **Date of Patent:** **** Apr. 28, 2015**

(54) **WINE DECANTER**

(71) Applicant: **James Hedley Dalby Rokos**, London
(GB)

(72) Inventor: **James Hedley Dalby Rokos**, London
(GB)

(**) Term: **14 Years**

(21) Appl. No.: **29/475,238**

(22) Filed: **Dec. 2, 2013**

(51) **LOC (10) Cl.** **07-01**

(52) **U.S. Cl.**
USPC **D7/300; D7/300.1; D7/598**

(58) **Field of Classification Search**
CPC A47G 23/02; B01D 50/00; B01L 3/08
USPC D7/300, 598, 316, 300.1, 321, 322, 509,
D7/591; D11/152, 143; D9/545, 546, 651,
D9/544, 553; 220/662, 703, 719, 713;
222/564; 215/11.1, 384; D23/207;
D24/113

See application file for complete search history.

(56) **References Cited**

U.S. PATENT DOCUMENTS

D20,030	S	*	7/1890	Bentley	D9/546
514,426	A	*	2/1894	Outerbridge, Jr.	422/556
D36,431	S	*	7/1903	Hitzl	D9/546
D50,297	S	*	2/1917	Dawson	D9/545
D58,091	S	*	6/1921	Heisler	D7/300
1,659,383	A	*	2/1928	Schott et al.	422/556
D109,221	S	*	4/1938	Kostellow	D7/300
2,566,035	A	*	8/1951	Schlumbohm	222/468
D211,978	S	*	8/1968	Douglas	D7/300
D234,900	S	*	4/1975	Achenbach	D7/598
D236,408	S	*	8/1975	Achenbach	D7/598
D257,818	S	*	1/1981	Plummer	D7/300
D268,248	S	*	3/1983	Bonnefoy	D9/522
D290,089	S	*	6/1987	Heriard-Dubreuil	D7/300
D321,319	S	*	11/1991	Giuseppe	D9/519
D338,834	S	*	8/1993	Paju	D9/545
D368,860	S	*	4/1996	Mansau	D9/545

D372,427	S	*	8/1996	Jago et al.	D9/500
D392,570	S	*	3/1998	Baron	D9/545
D476,237	S	*	6/2003	Canepa	D9/545
D514,368	S	*	2/2006	Rocha	D7/300
D534,430	S	*	1/2007	Alameddine et al.	D9/519
D545,135	S	*	6/2007	Bodum	D7/598
D545,136	S	*	6/2007	Bodum	D7/598
D576,883	S	*	9/2008	Carapelli	D9/522
D579,259	S	*	10/2008	Venier	D7/316

(Continued)

Primary Examiner — Marianne Pandozzi
Assistant Examiner — Jae Liang

(57) **CLAIM**

The ornamental design for a wine decanter, as shown and described.

DESCRIPTION

FIG. 1 is a front elevation view of a wine decanter showing my new design in a first position for use;
 FIG. 2 is a side elevation view thereof;
 FIG. 3 is a top view thereof;
 FIG. 4 is a perspective view thereof;
 FIG. 5 is a front elevation view of a wine decanter in a second position for use;
 FIG. 6 is a side elevation view thereof;
 FIG. 7 is a top view thereof;
 FIG. 8 is a perspective view thereof;
 FIG. 9 is a front elevation view of a wine decanter in a third position for use;
 FIG. 10 is a side elevation view thereof;
 FIG. 11 is a top view thereof;
 FIG. 12 is a perspective view thereof,
 FIG. 13 is a front elevation view of a wine decanter in a fourth position for use;
 FIG. 14 is a side elevation view thereof;
 FIG. 15 is a top view thereof; and,
 FIG. 16 is a perspective view thereof.
 The decanter design includes three dimpled bases in its rounded body.

1 Claim, 8 Drawing Sheets

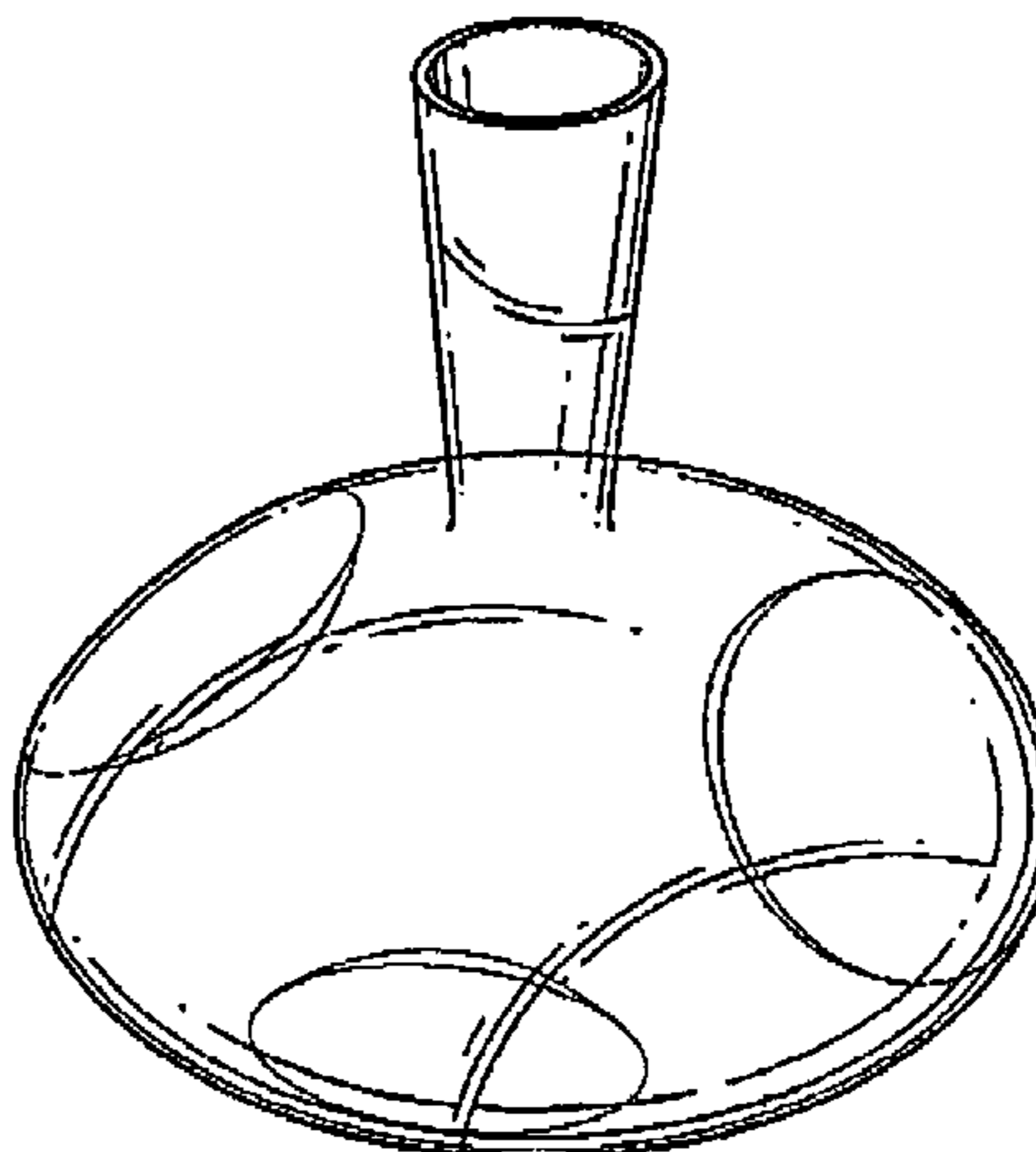
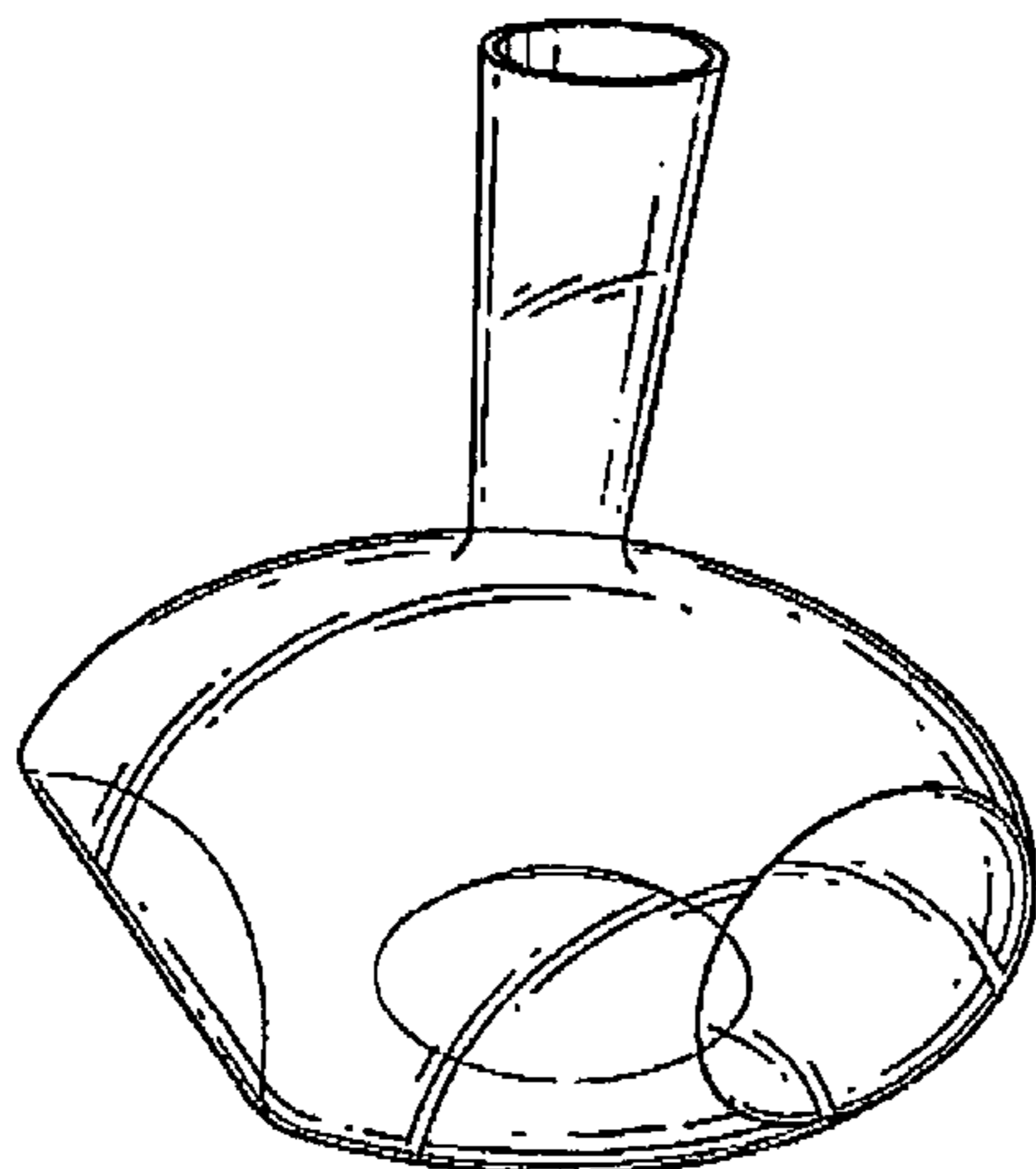

(56)

References Cited

U.S. PATENT DOCUMENTS

D602,358 S *	10/2009	Eisen	D9/505	D663,589 S *	7/2012	Pascot	D7/509
D602,359 S *	10/2009	Eisen	D9/505	D673,415 S *	1/2013	Genuardi	D7/300.1
D608,650 S *	1/2010	Eisen	D9/545	D676,713 S *	2/2013	Jalet	D7/598
D633,804 S *	3/2011	Podewski	D9/522	D681,384 S *	5/2013	Fitzpatrick	D7/300
D652,680 S *	1/2012	Straka et al.	D7/505	D685,218 S *	7/2013	Willat et al.	D7/316
					D693,693 S *	11/2013	Sanchez	D9/545
					D697,410 S *	1/2014	Glasman	D9/503
					2003/0000954 A1 *	1/2003	Smith	220/662

* cited by examiner

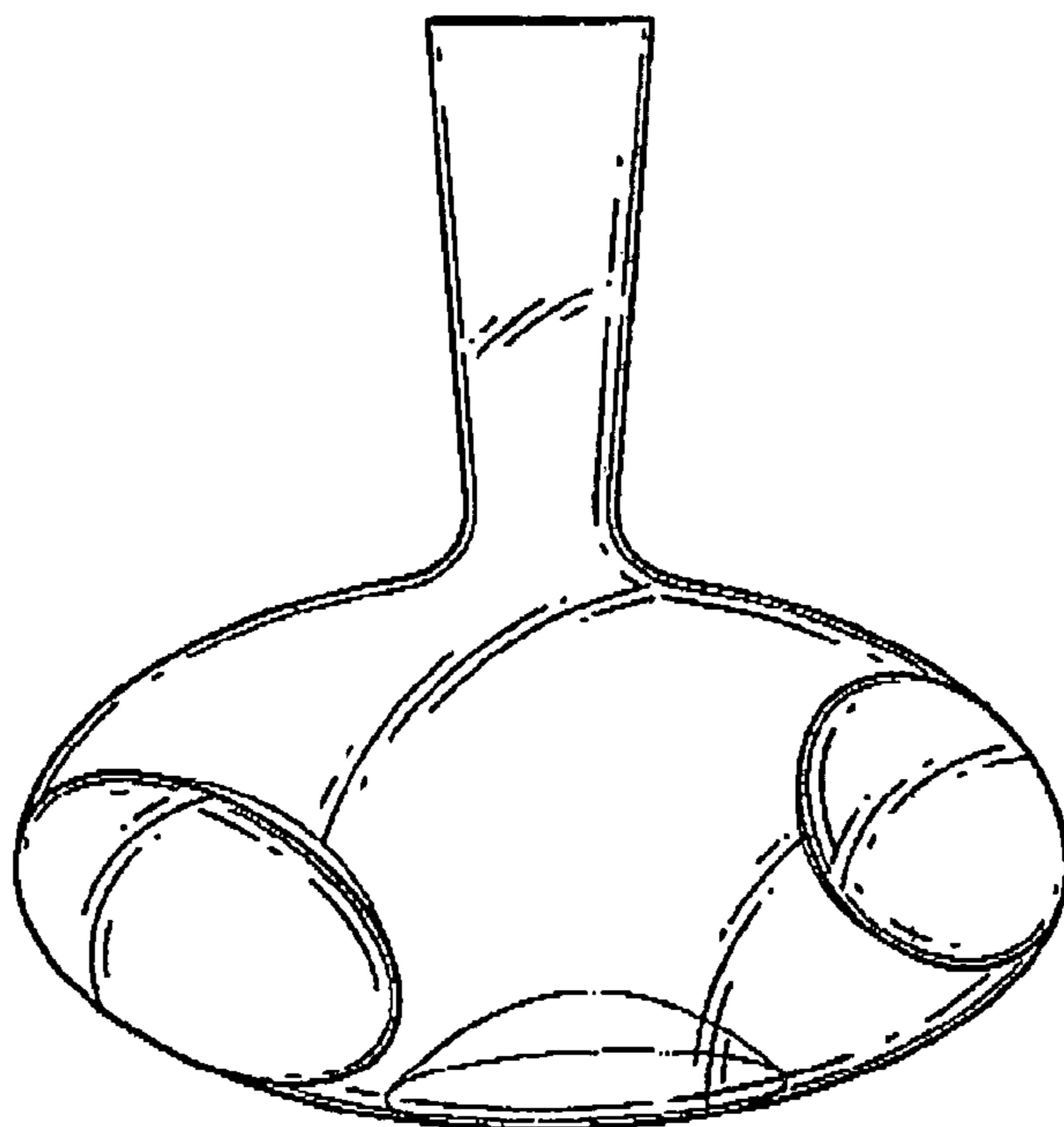

FIG. 1

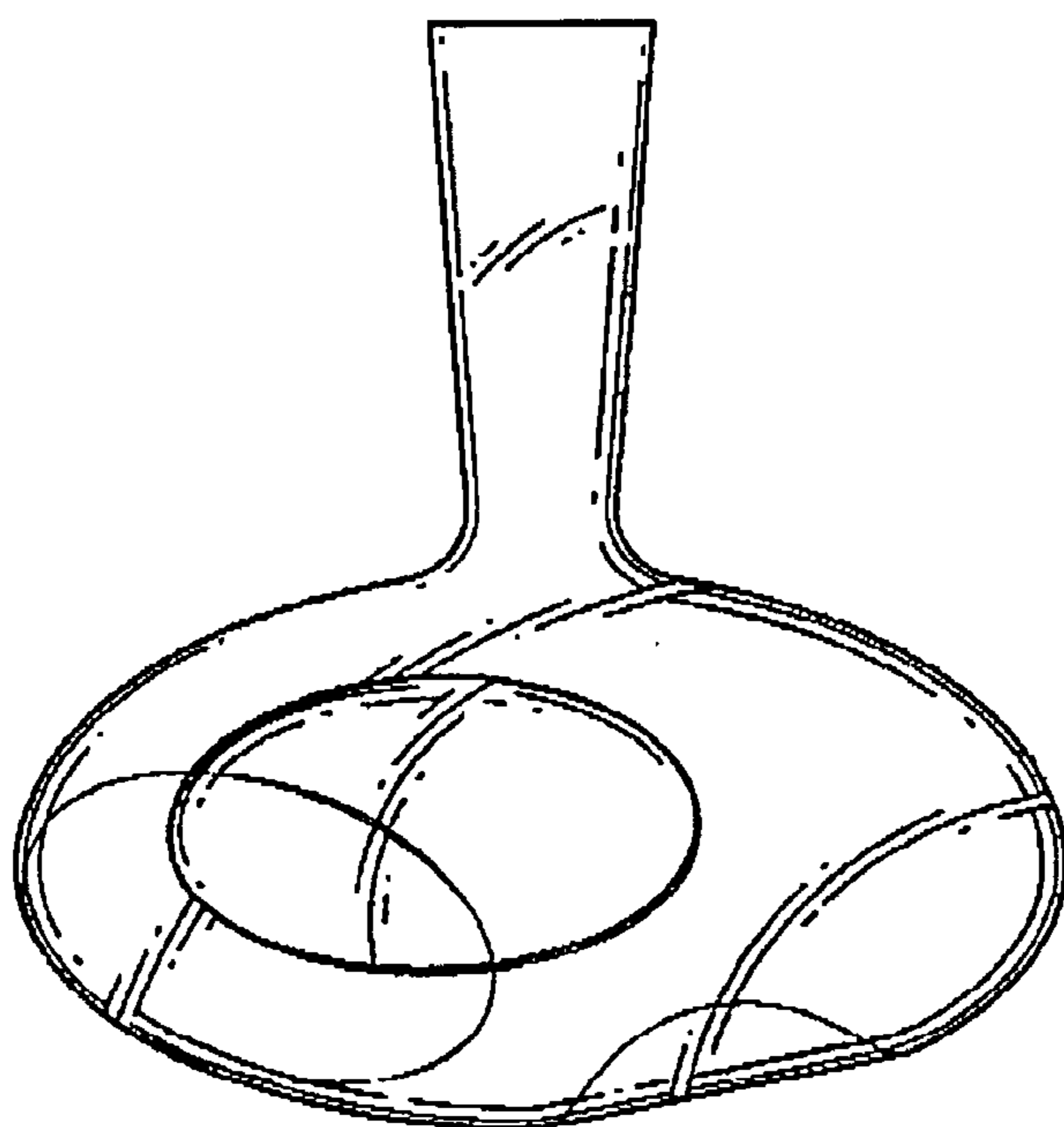

FIG. 2

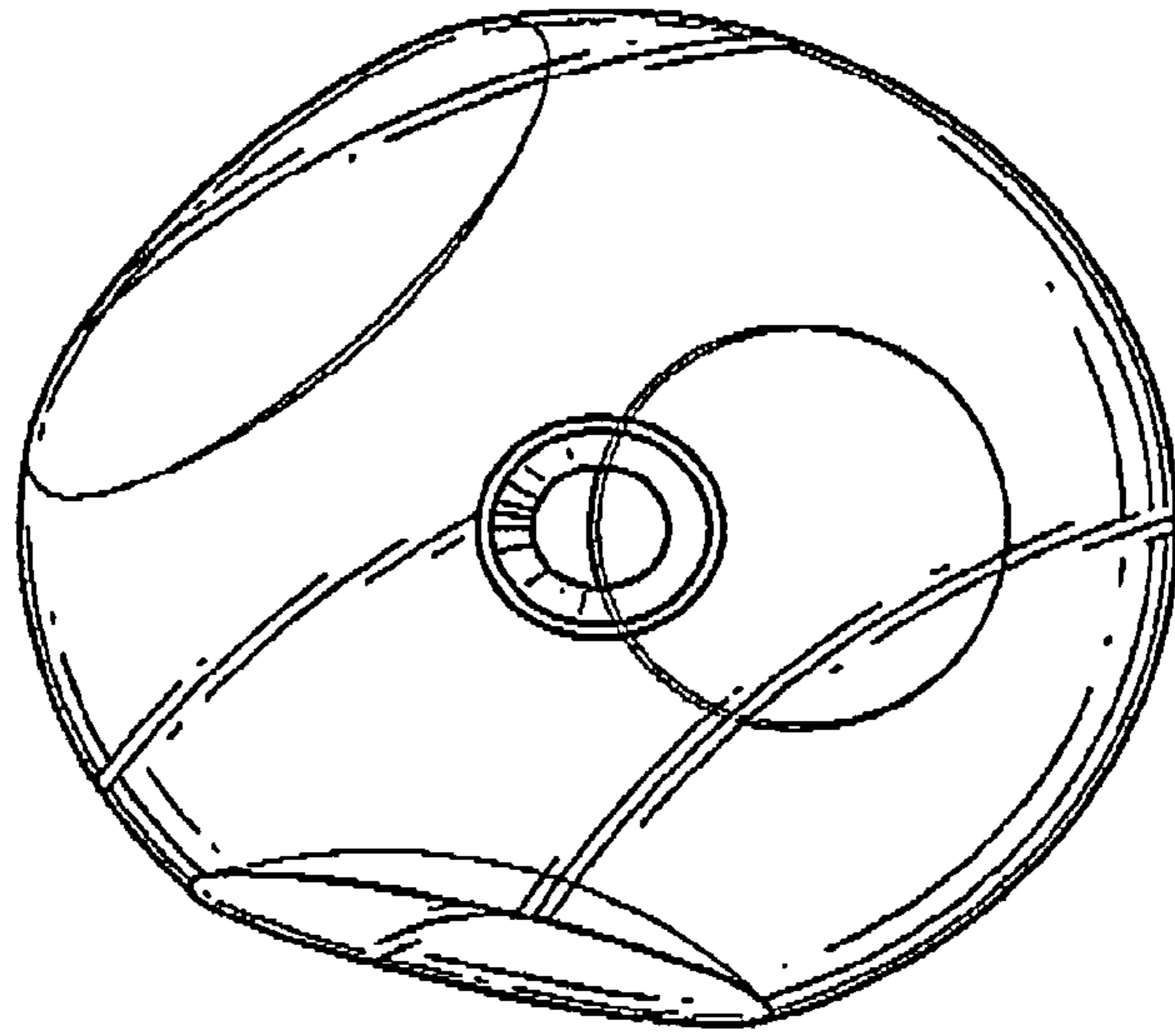

FIG. 3

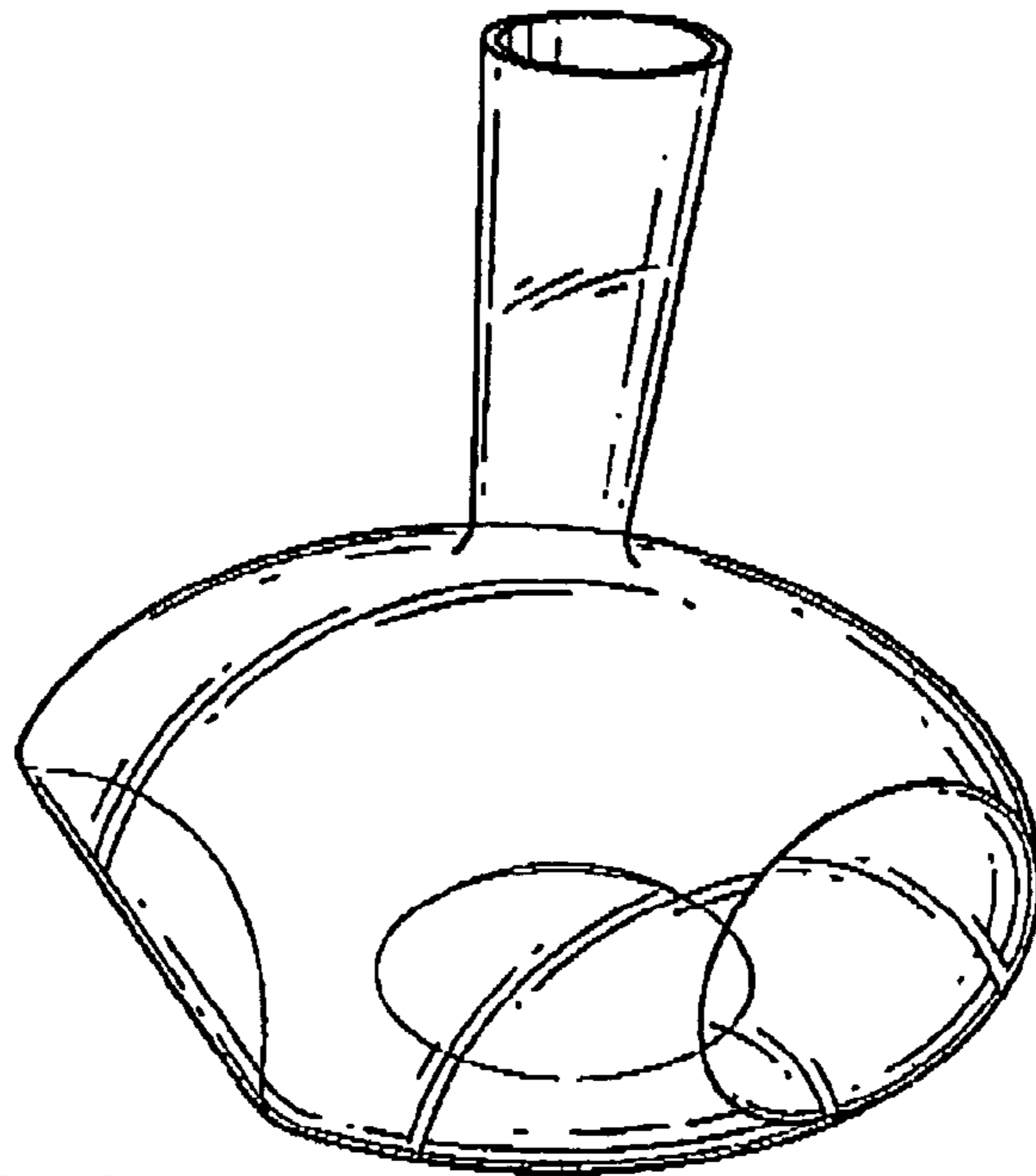

FIG. 4

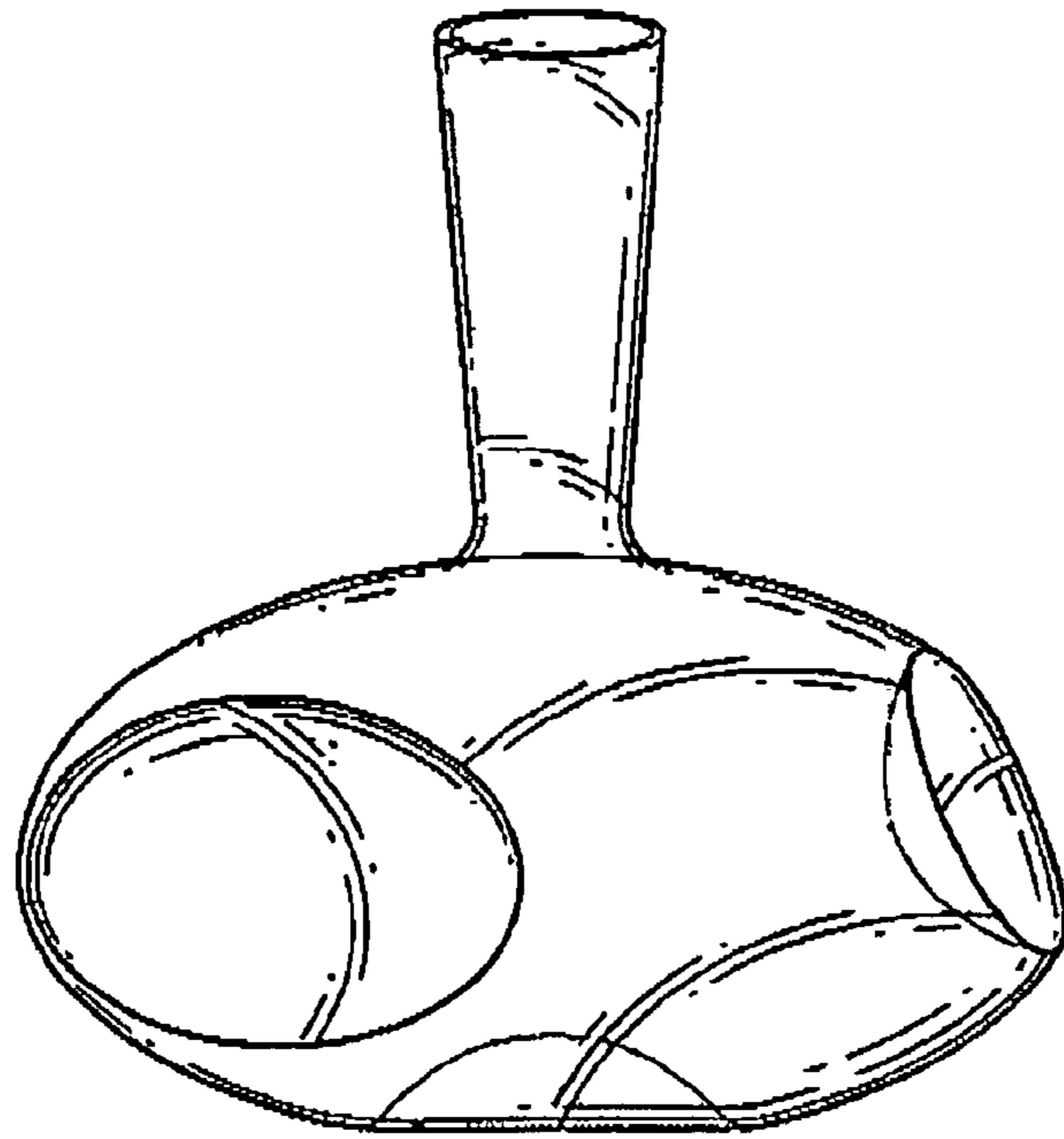

FIG. 5

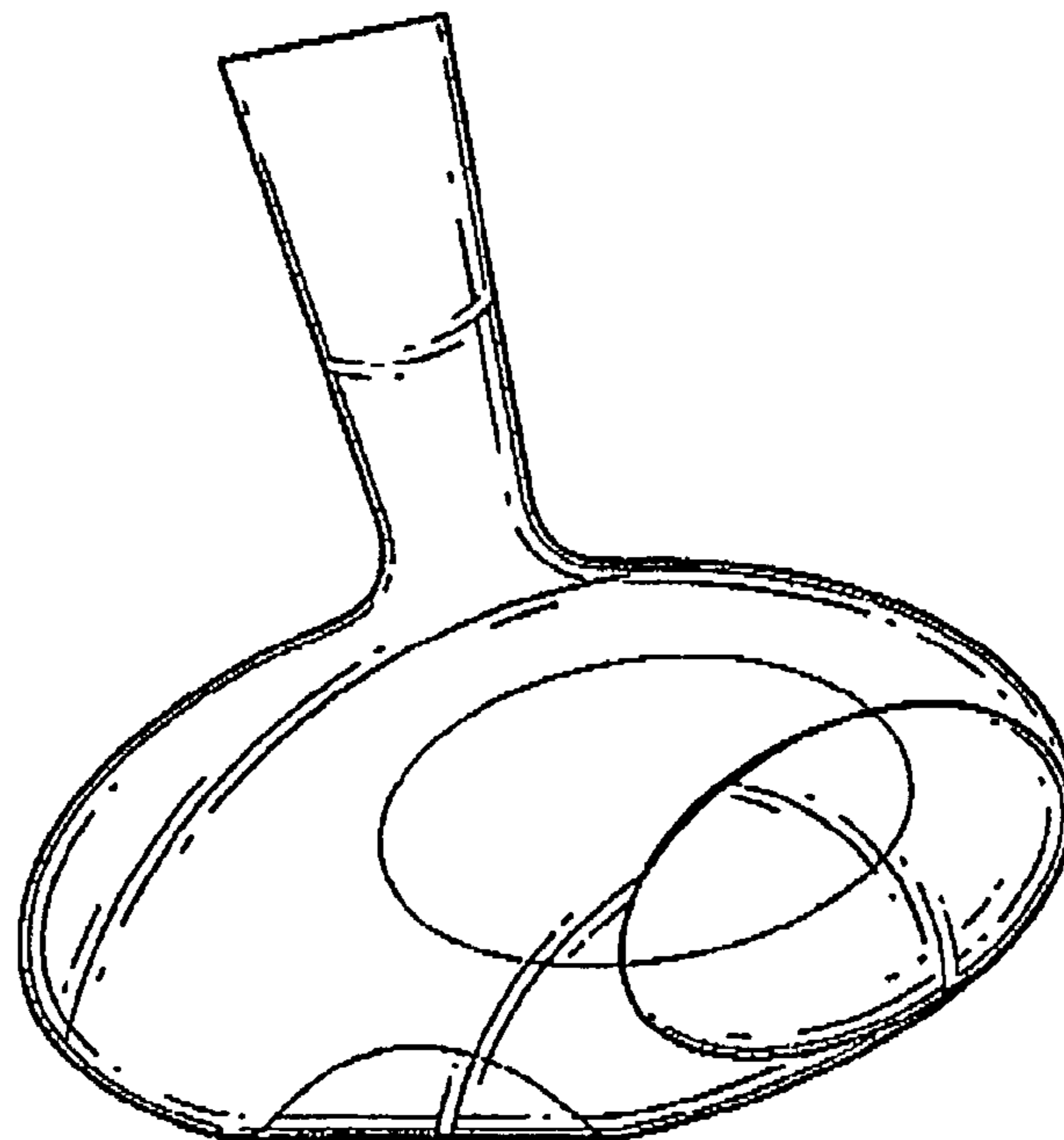

FIG. 6

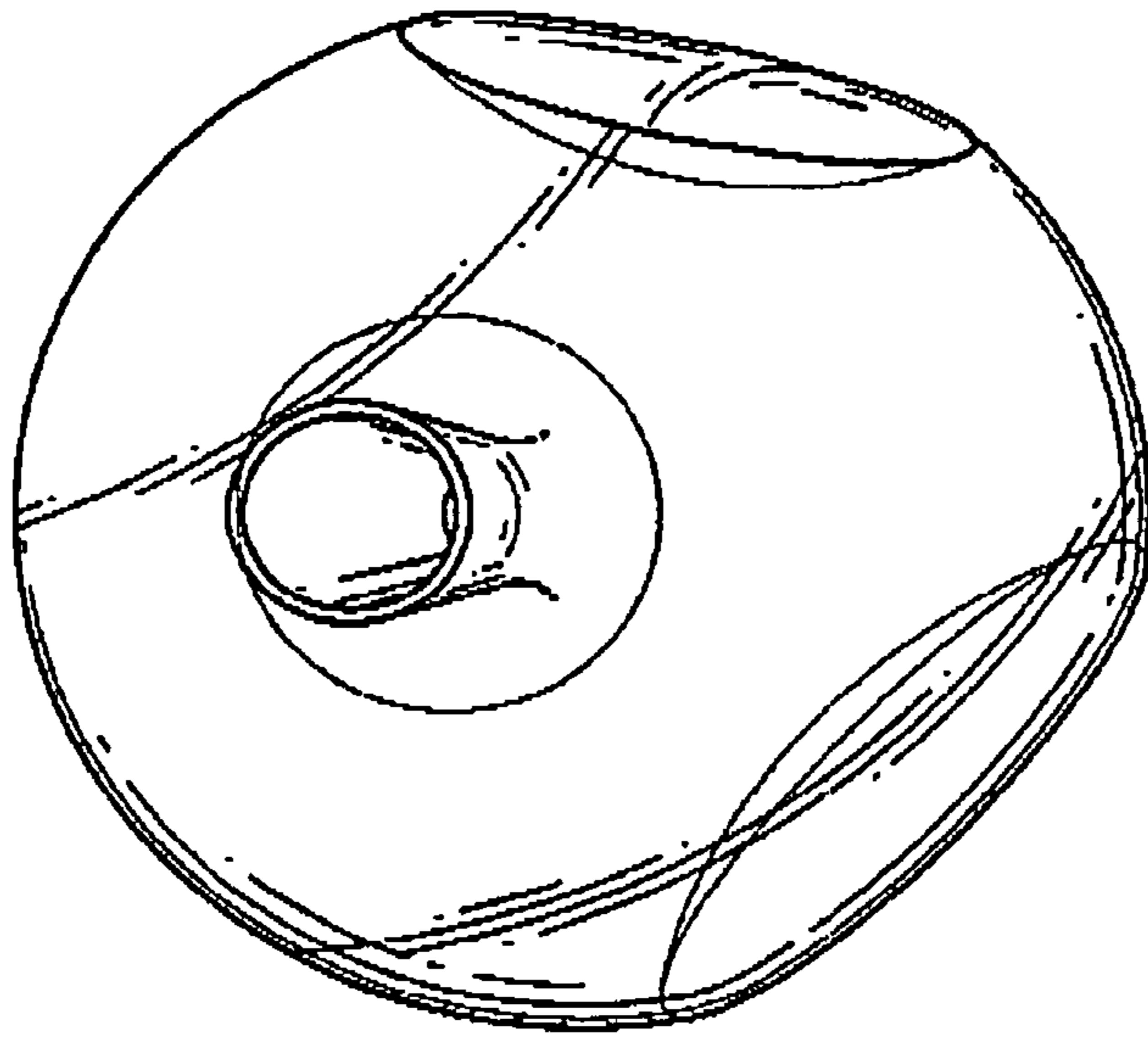

FIG. 7

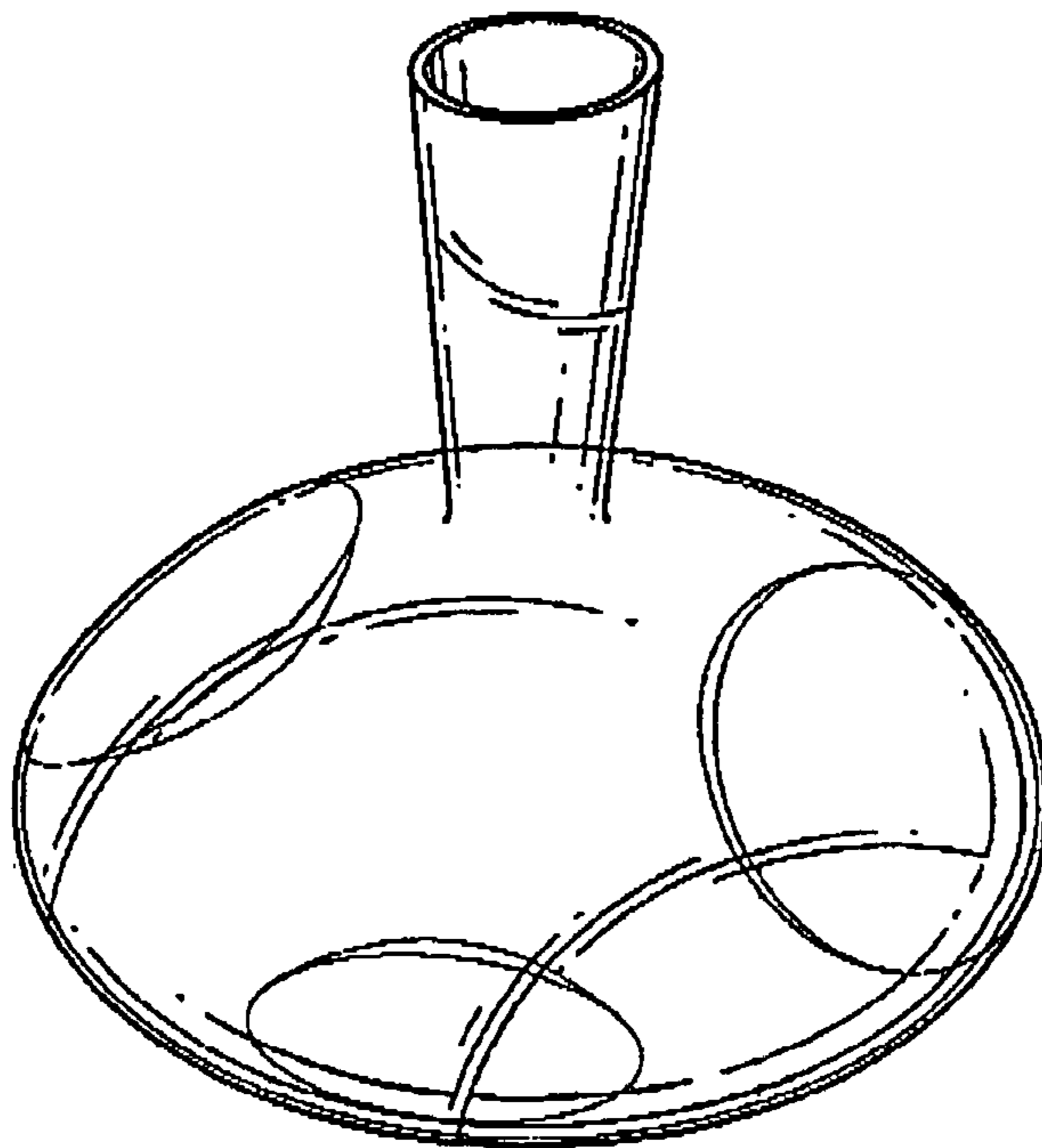

FIG. 8

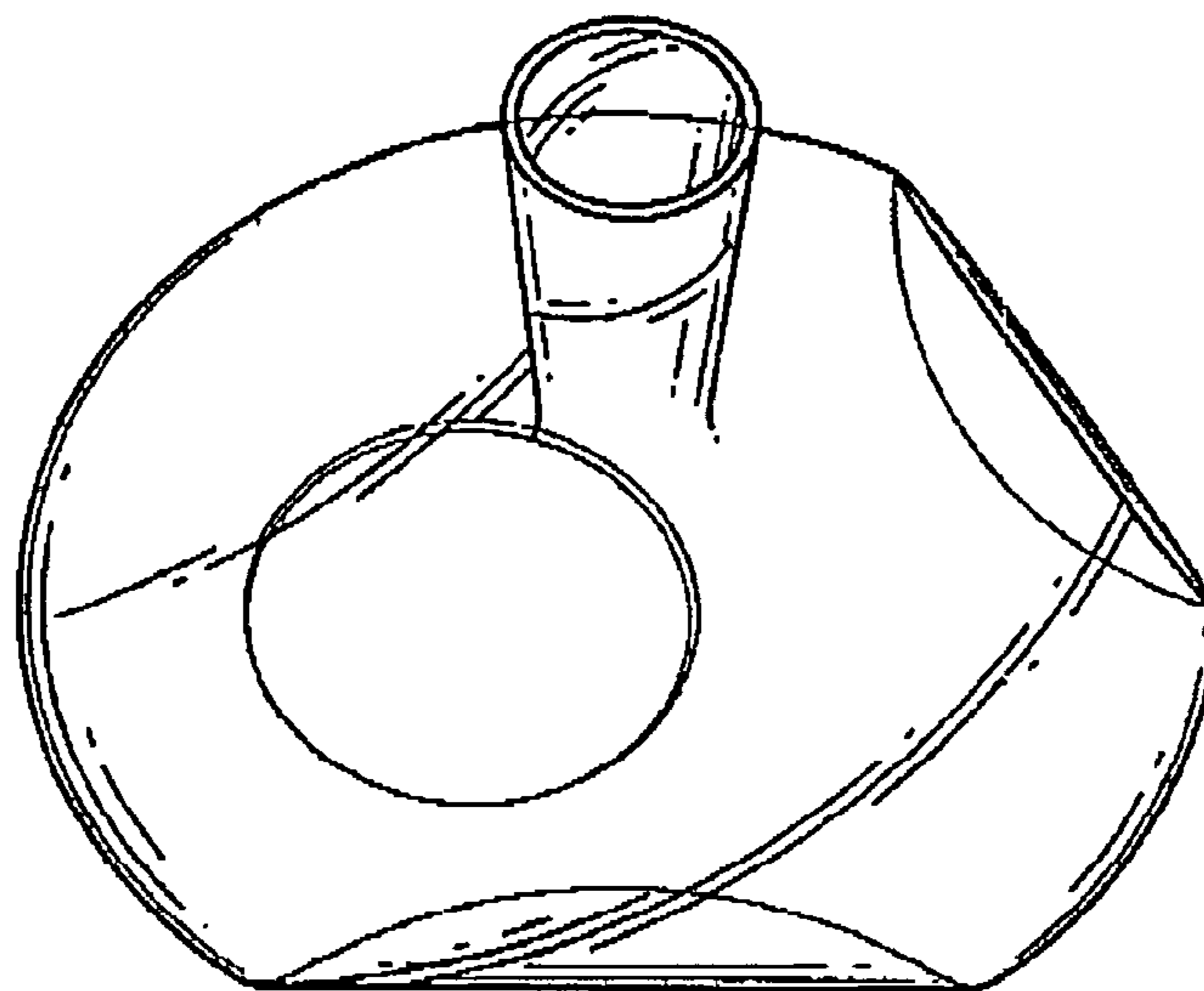

FIG. 9

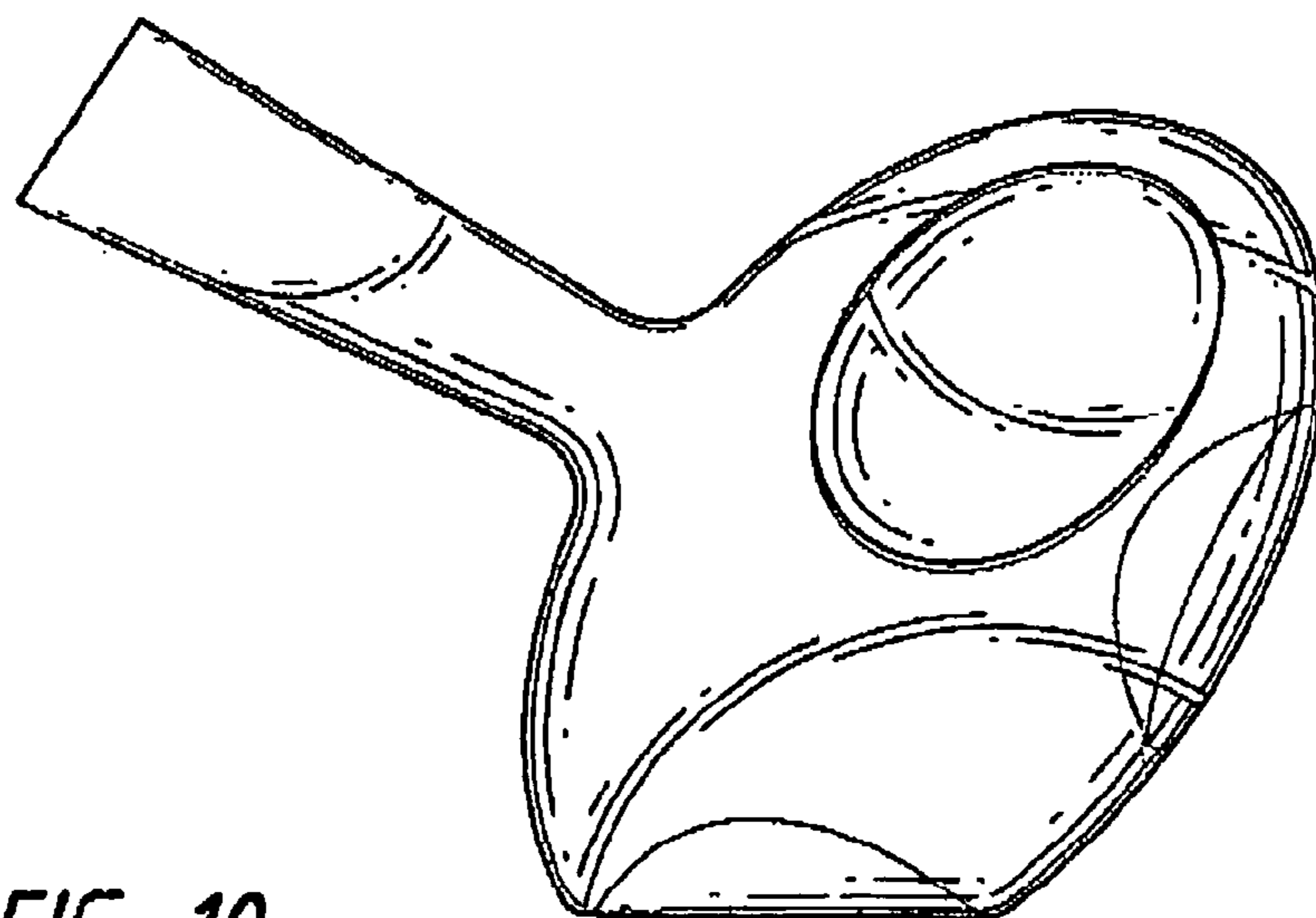

FIG. 10

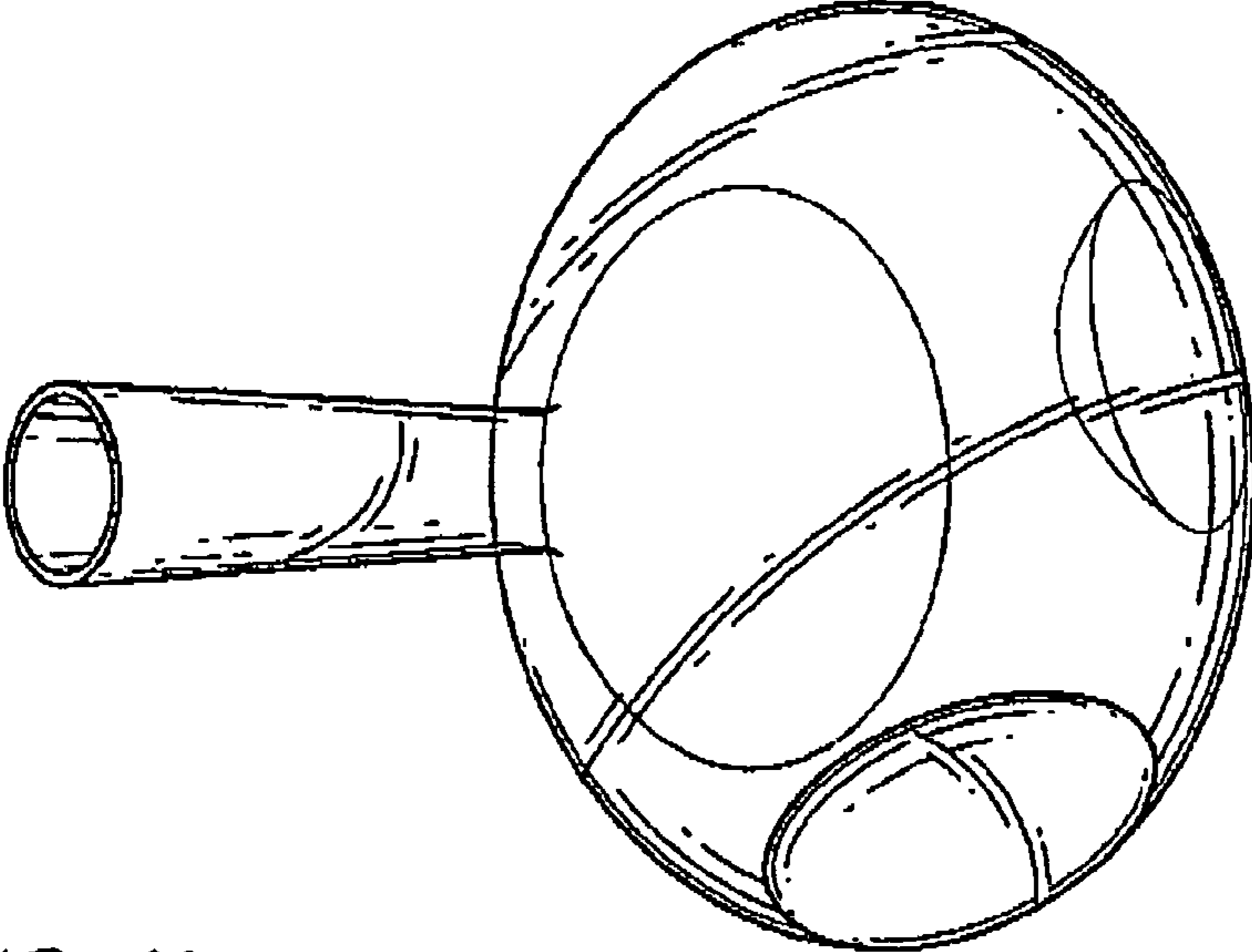

FIG. 11

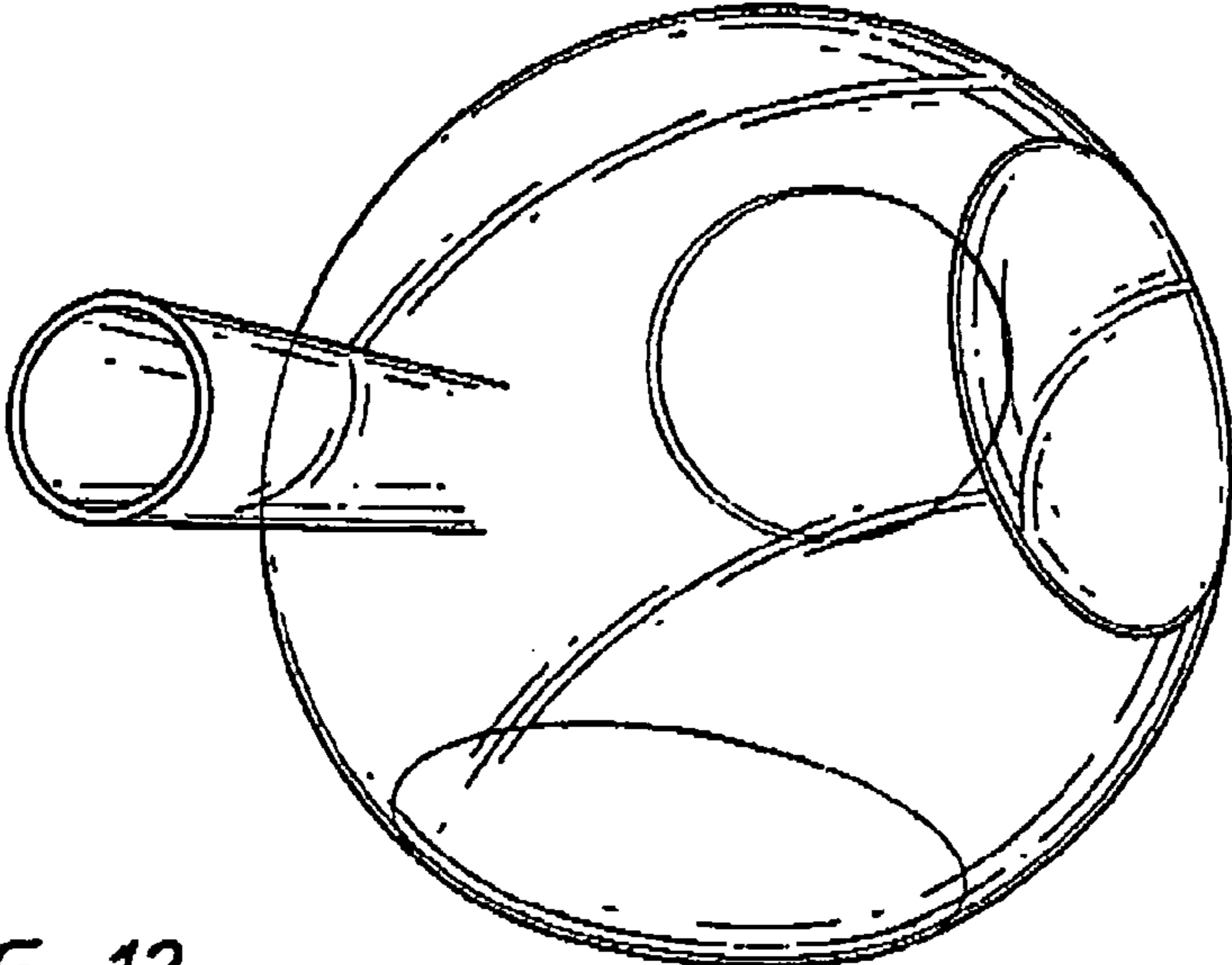

FIG. 12

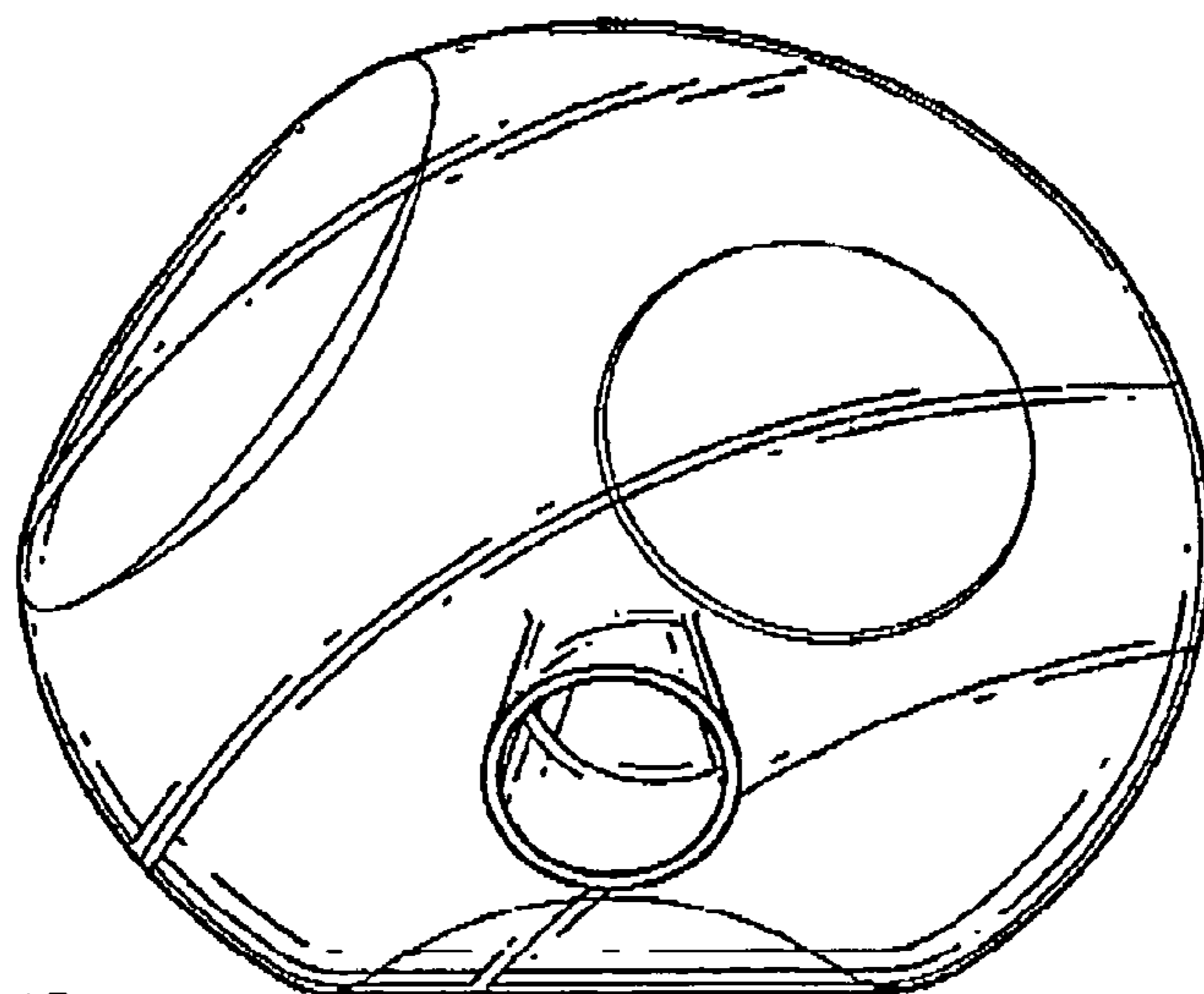

FIG. 13

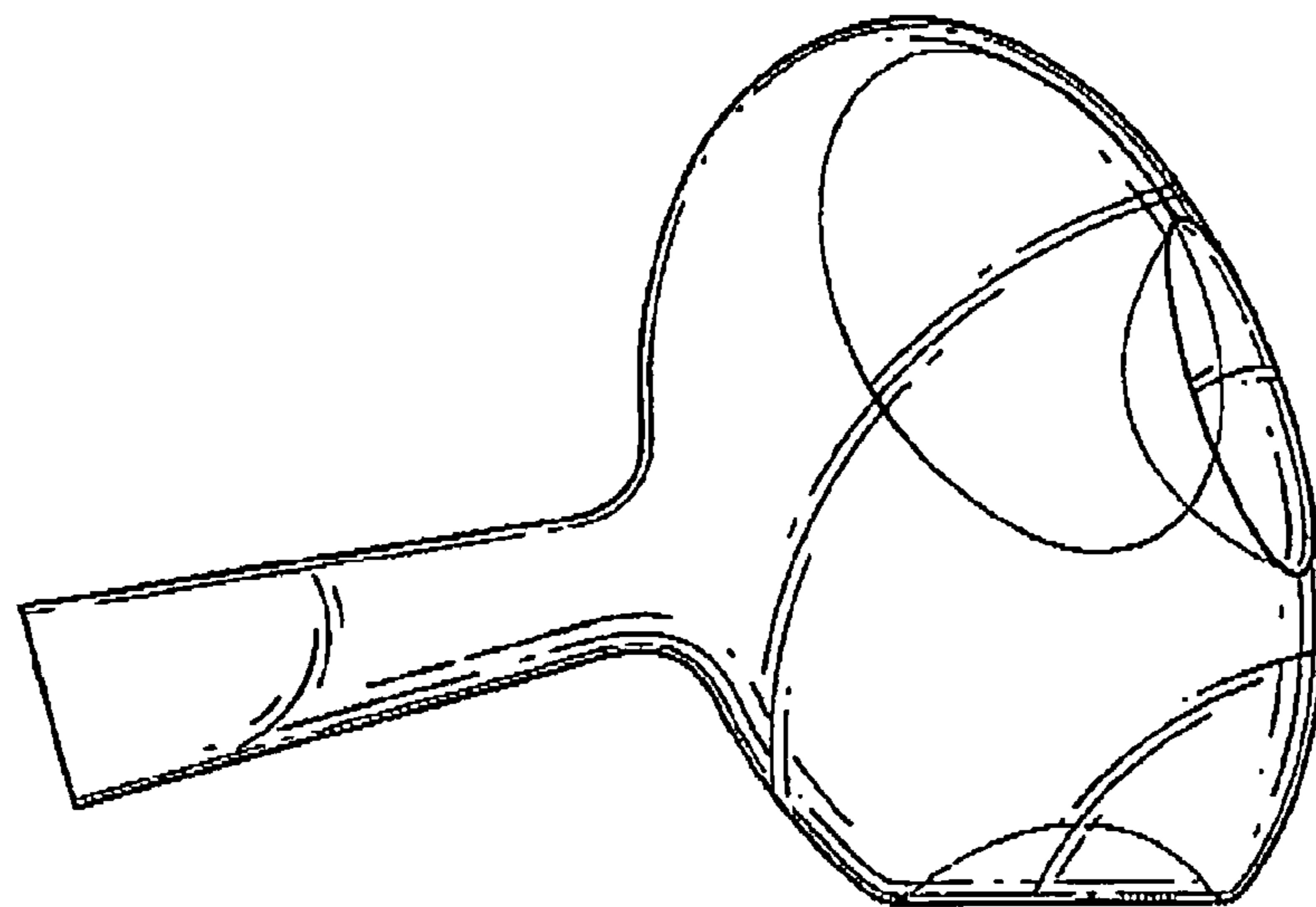

FIG. 14

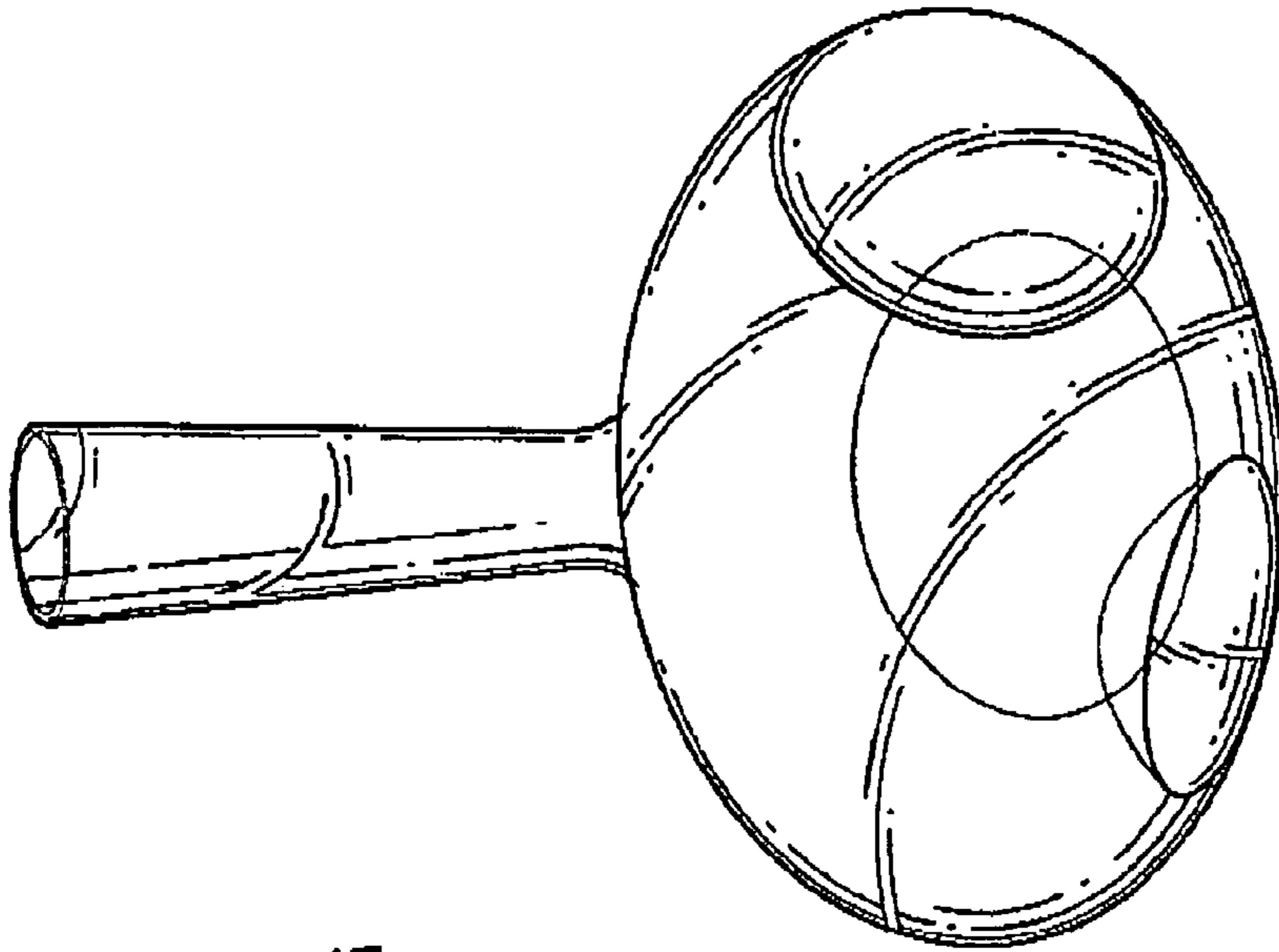

FIG. 15

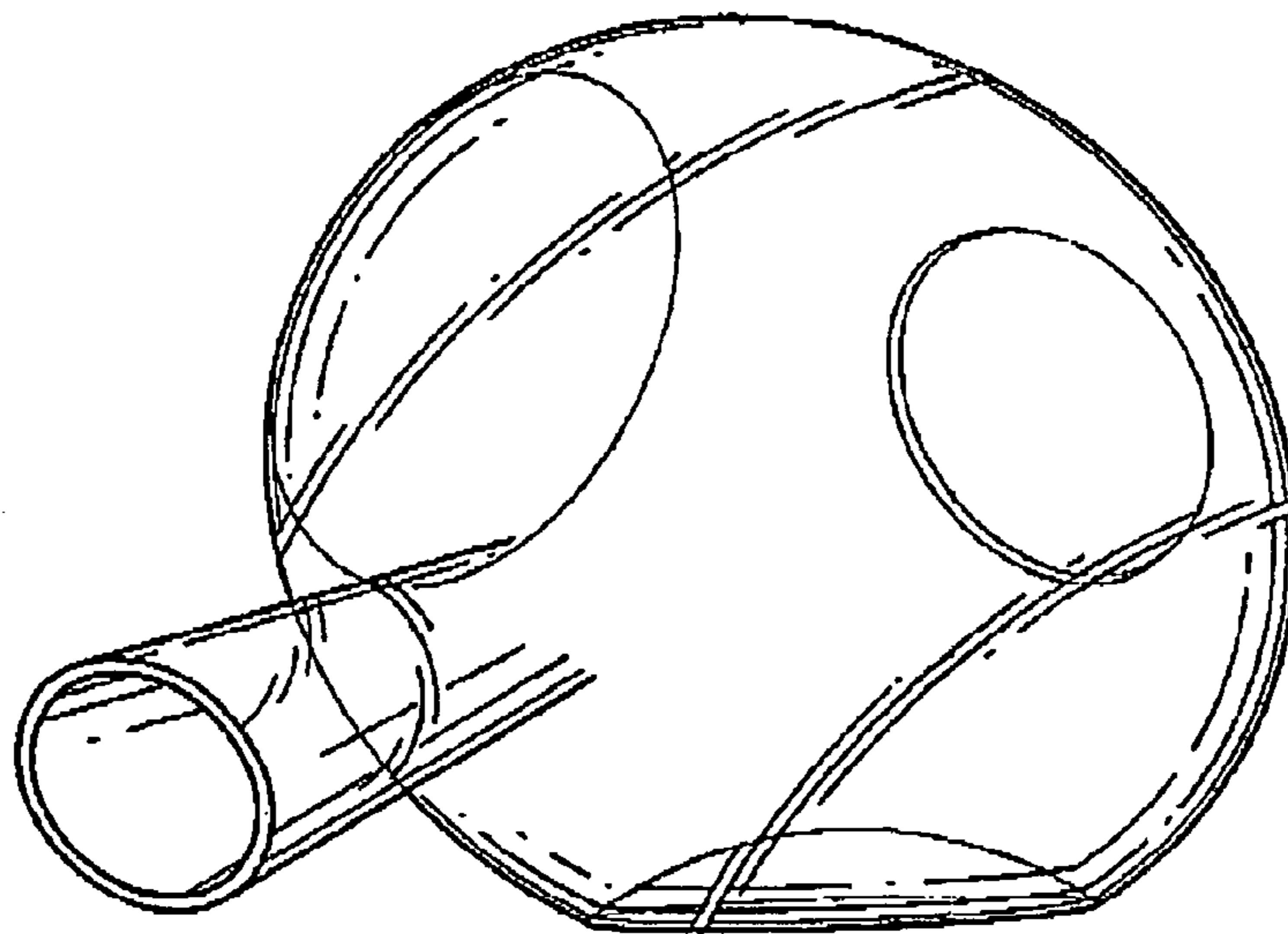

FIG. 16