



US00D727604S

(12) **United States Design Patent**  
**Padmore**

(10) **Patent No.:** **US D727,604 S**  
(45) **Date of Patent:** **\*\* Apr. 28, 2015**

- (54) **ELONGATED AQUATIC CAP**
- (71) Applicant: **Tess M. Padmore**, Rochester, NY (US)
- (72) Inventor: **Tess M. Padmore**, Rochester, NY (US)
- (\*\*) Term: **14 Years**
- (21) Appl. No.: **29/432,706**
- (22) Filed: **Sep. 19, 2012**
- (51) **LOC (10) Cl.** ..... **02-03**
- (52) **U.S. Cl.**  
USPC ..... **D2/867**
- (58) **Field of Classification Search**  
USPC ..... D2/865, 866, 867, 868, 878, 877, 880,  
D2/881, 883, 885; D29/102, 103, 104,  
D29/105, 106; 2/68, 171, 175.3, 200.2, 202,  
2/203, 204, 205, 207; D28/93; 132/274  
See application file for complete search history.

(56) **References Cited**

**U.S. PATENT DOCUMENTS**

D130,227	S	*	11/1941	Maxwell et al.	.....	D2/885
D207,627	S		5/1967	Reinsberg		
4,378,606	A	*	4/1983	Snowden	.....	2/200.1
5,203,358	A	*	4/1993	Eytcheson	.....	132/212
5,309,574	A	*	5/1994	Balaban et al.	.....	2/202
5,566,689	A	*	10/1996	Yeater	.....	132/212
D388,589	S	*	1/1998	Walker	.....	D2/867
6,427,251	B1	*	8/2002	Leach	.....	2/174
6,948,190	B2	*	9/2005	McGreggor	.....	2/202
D513,661	S	*	1/2006	Handy	.....	D2/881
D533,273	S	*	12/2006	Witt	.....	D24/128
D641,140	S	*	7/2011	Clarke	.....	D2/867
D669,662	S	*	10/2012	Reid	.....	D2/867
2006/0288467	A1	*	12/2006	Jones	.....	2/174
2009/0038048	A1	*	2/2009	Thompson	.....	2/68
2009/0151048	A1	*	6/2009	Laury	.....	2/202
2010/0192273	A1	*	8/2010	Dodd	.....	2/68
2012/0023642	A1	*	2/2012	Holland	.....	2/207
2013/0247269	A1	*	9/2013	Alburg	.....	2/68

**OTHER PUBLICATIONS**

EggHeadSoque photos (on-line), posted on the EggHeadSoque Facebook page Jul. 17, 2012. Retrieved from Internet Sep. 26, 2014,

URL: <https://www.facebook.com/255837187859601/photos/pb.255837187859601.-2207520000.1411739298./255837834526203/?type=3&theater> (2 pages).\*

Black Dread Hat (on-line), photo posted on Dreadscapes Dreadlocks Facebook page Jun. 1, 2012. Retrieved from Internet Sep. 25, 2014, URL: <https://www.facebook.com/dreadscapes.dreadlocks/photos/pb.138445406221138.2207520000.1411675971./358848524180824/?type=1&theater> (1 page).\*

\* cited by examiner

*Primary Examiner* — Karen E. Eldridge Powers

*Assistant Examiner* — Kimberly Barnes

(74) *Attorney, Agent, or Firm* — Tracy Jong Law Firm; Tracy P. Jong; Cheng Ning Jong

(57) **CLAIM**

The ornamental design for an elongated aquatic cap, as shown and described.

**DESCRIPTION**

FIG. 1 is a front elevation view of an elongated aquatic cap as worn by a user.

FIG. 2 is a top plan view thereof.

FIG. 3 is a left side elevation view thereof.

FIG. 4 is a right side elevation view thereof.

FIG. 5 is a rear elevation view thereof.

FIG. 6 is a bottom perspective view thereof.

FIG. 7 is a top front perspective view of the elongated aquatic cap, shown as it would appear when not worn.

FIG. 8 is a bottom rear perspective view thereof.

FIG. 9 is a top plan view thereof.

FIG. 10 is a bottom plan view thereof.

FIG. 11 is a right side elevation view thereof.

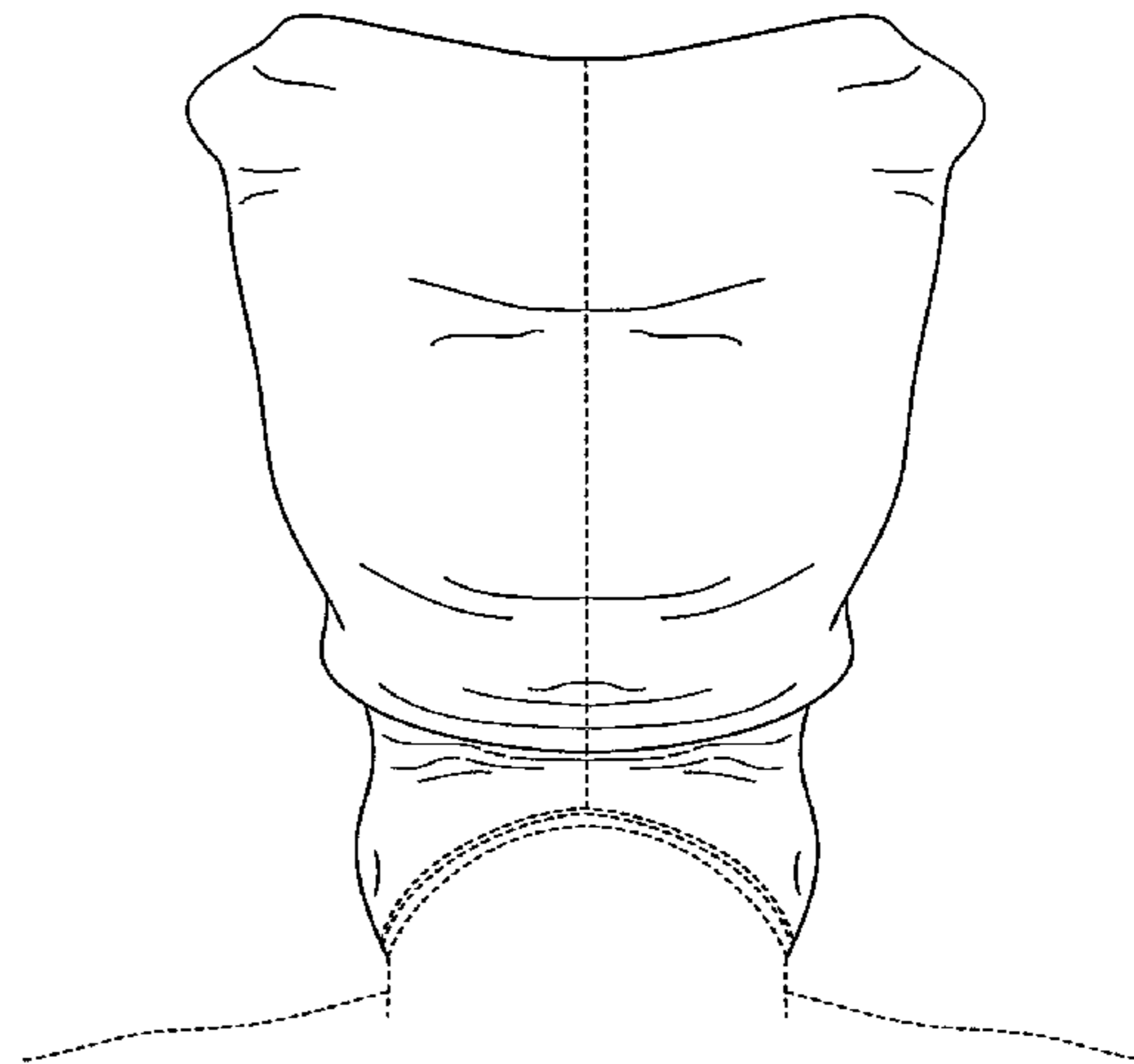
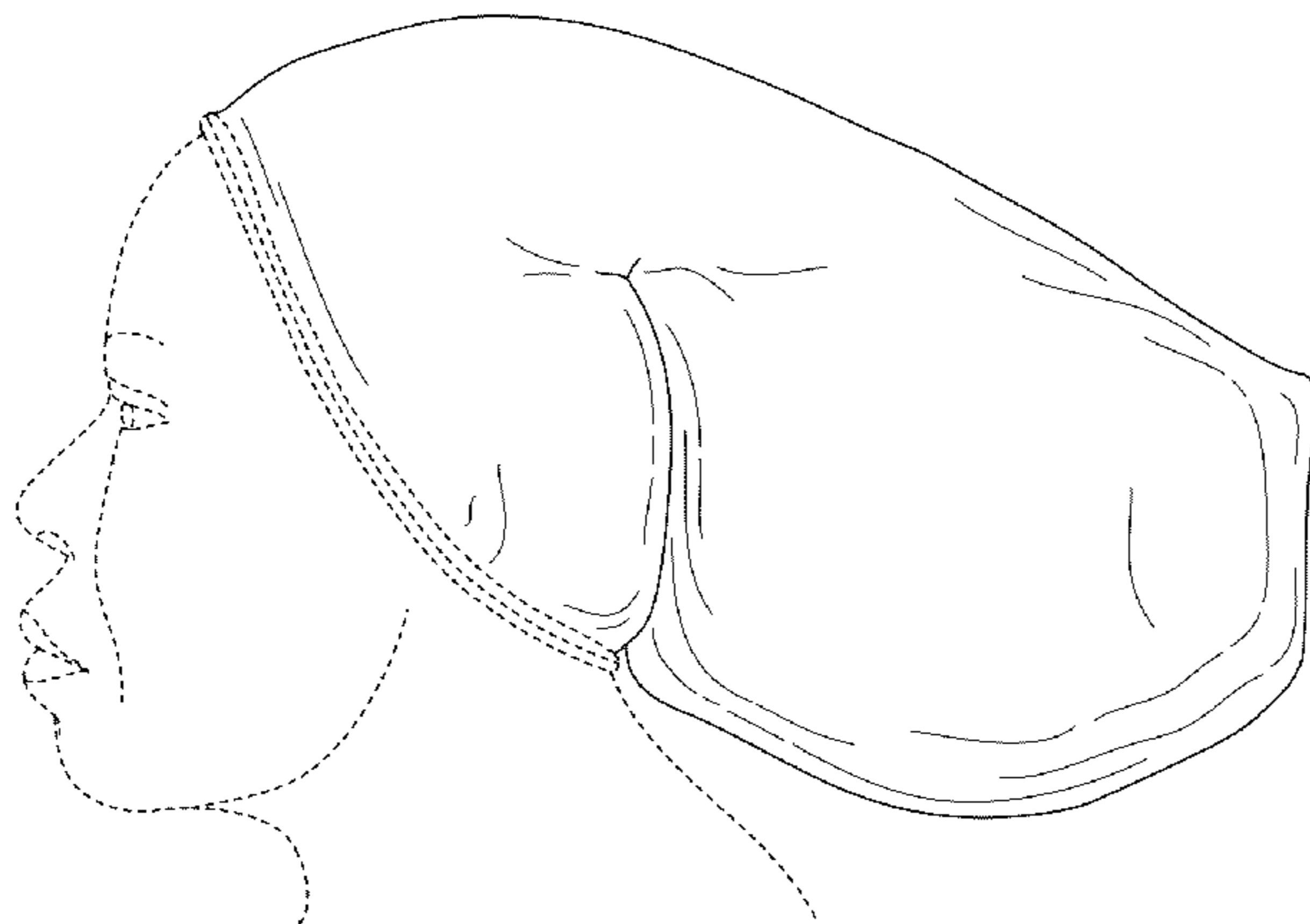
FIG. 12 is a left side elevation view thereof.

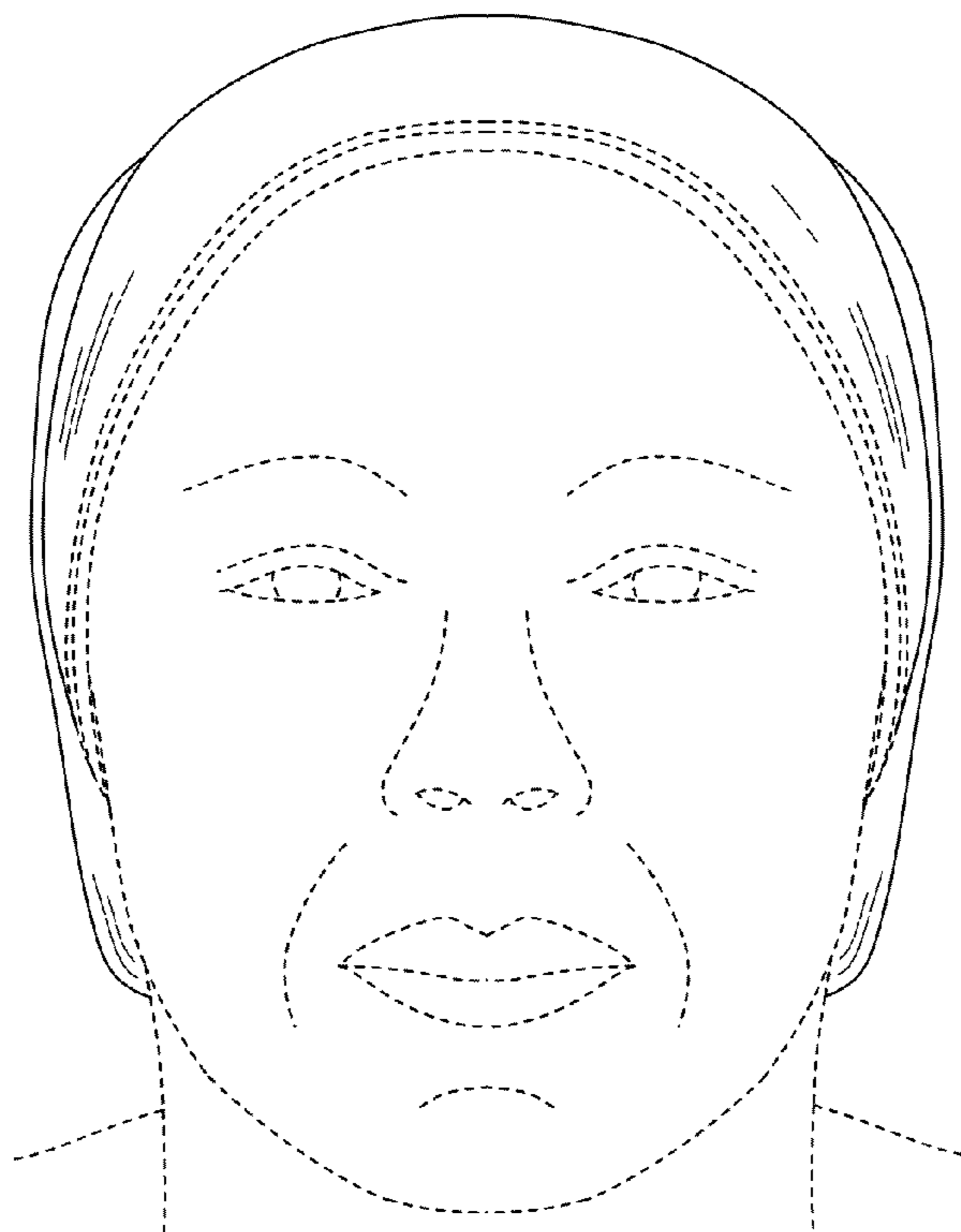
FIG. 13 is a front elevation view thereof; and,

FIG. 14 is a rear elevation view thereof.

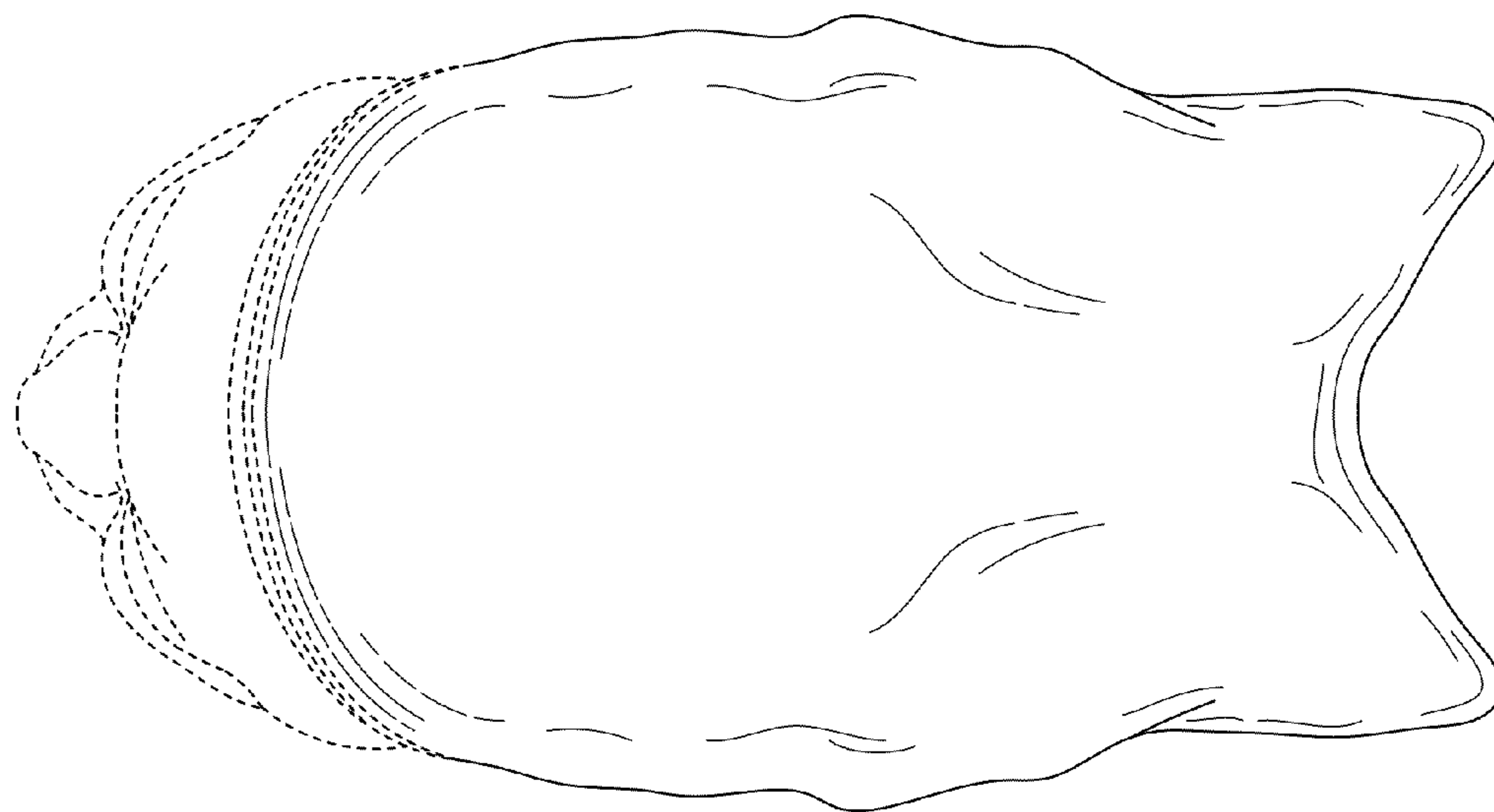
The face, head, and shoulders shown in broken lines are environmental subject matter included to depict how the claimed design may appear when worn and form no part of the claimed design. The remaining broken line subject matter is unclaimed features.

**1 Claim, 6 Drawing Sheets**

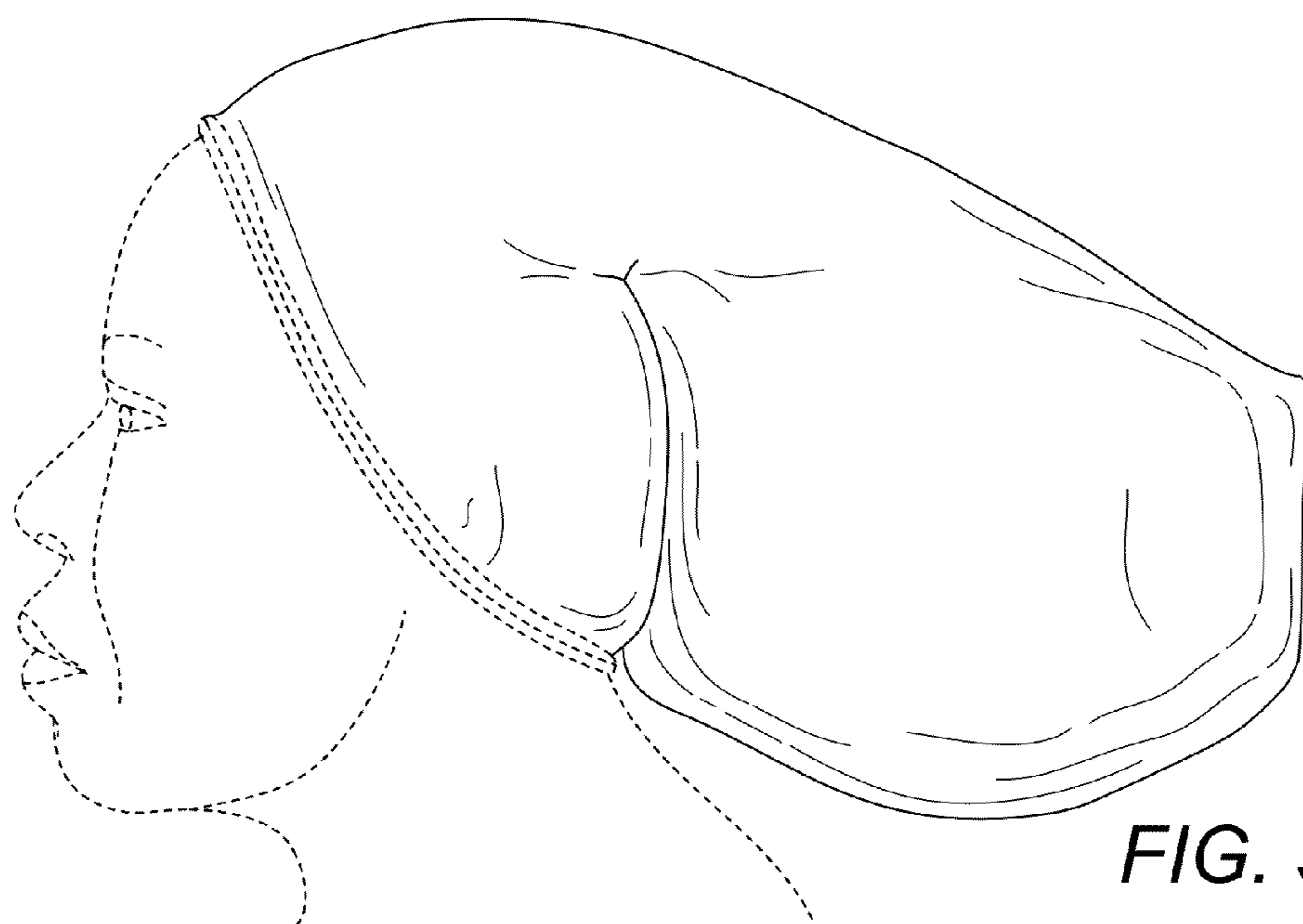




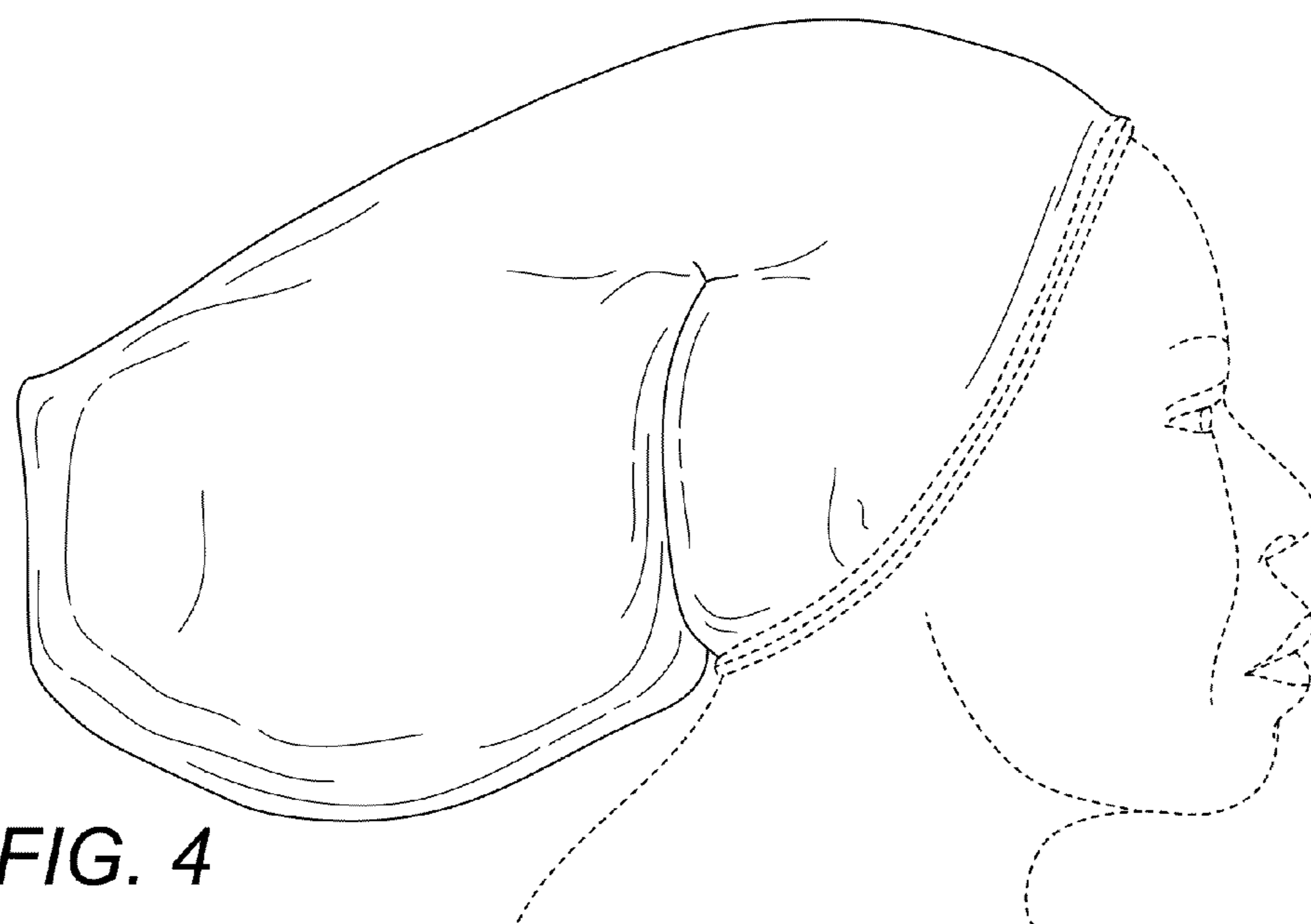
**FIG. 1**



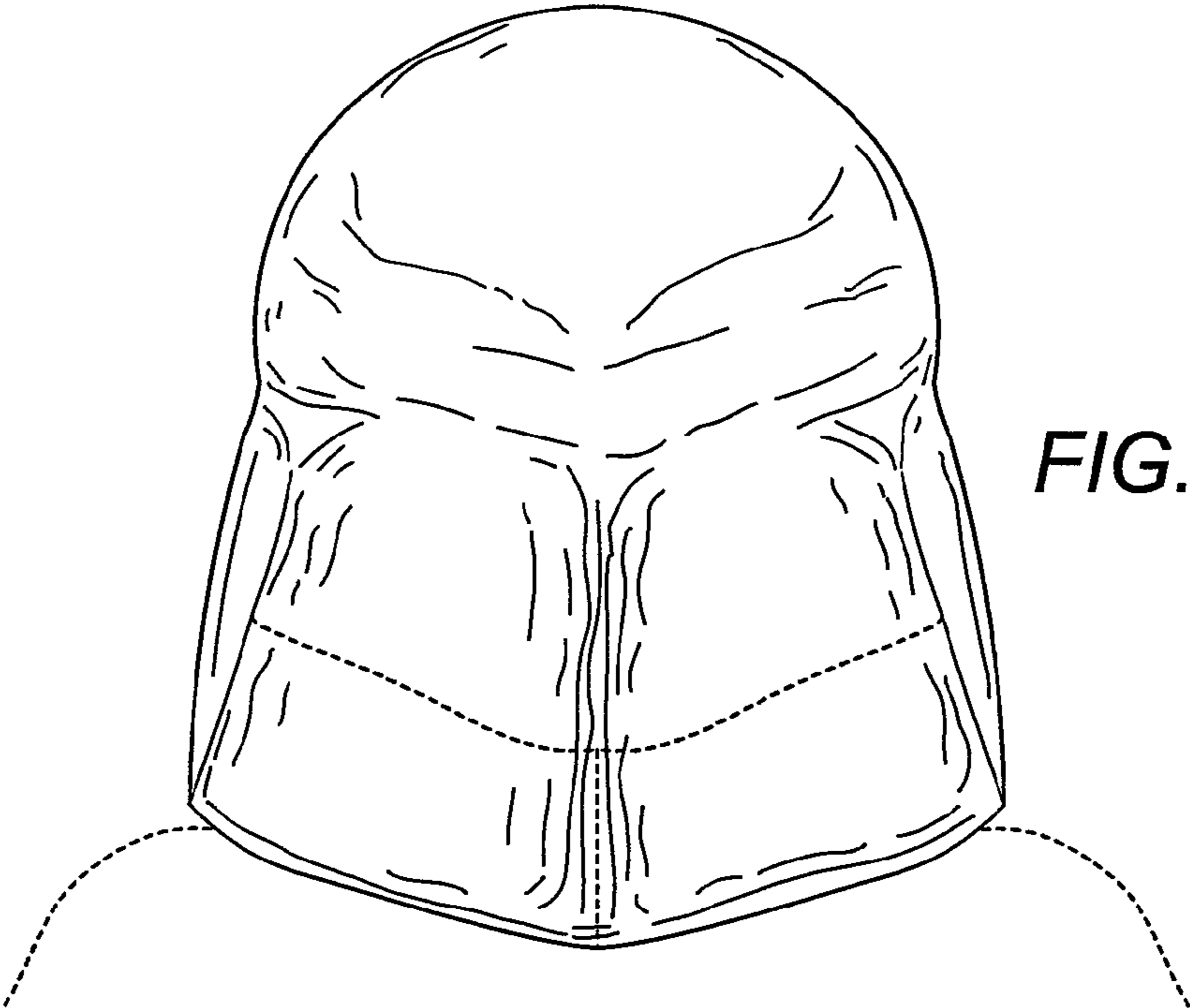
**FIG. 2**



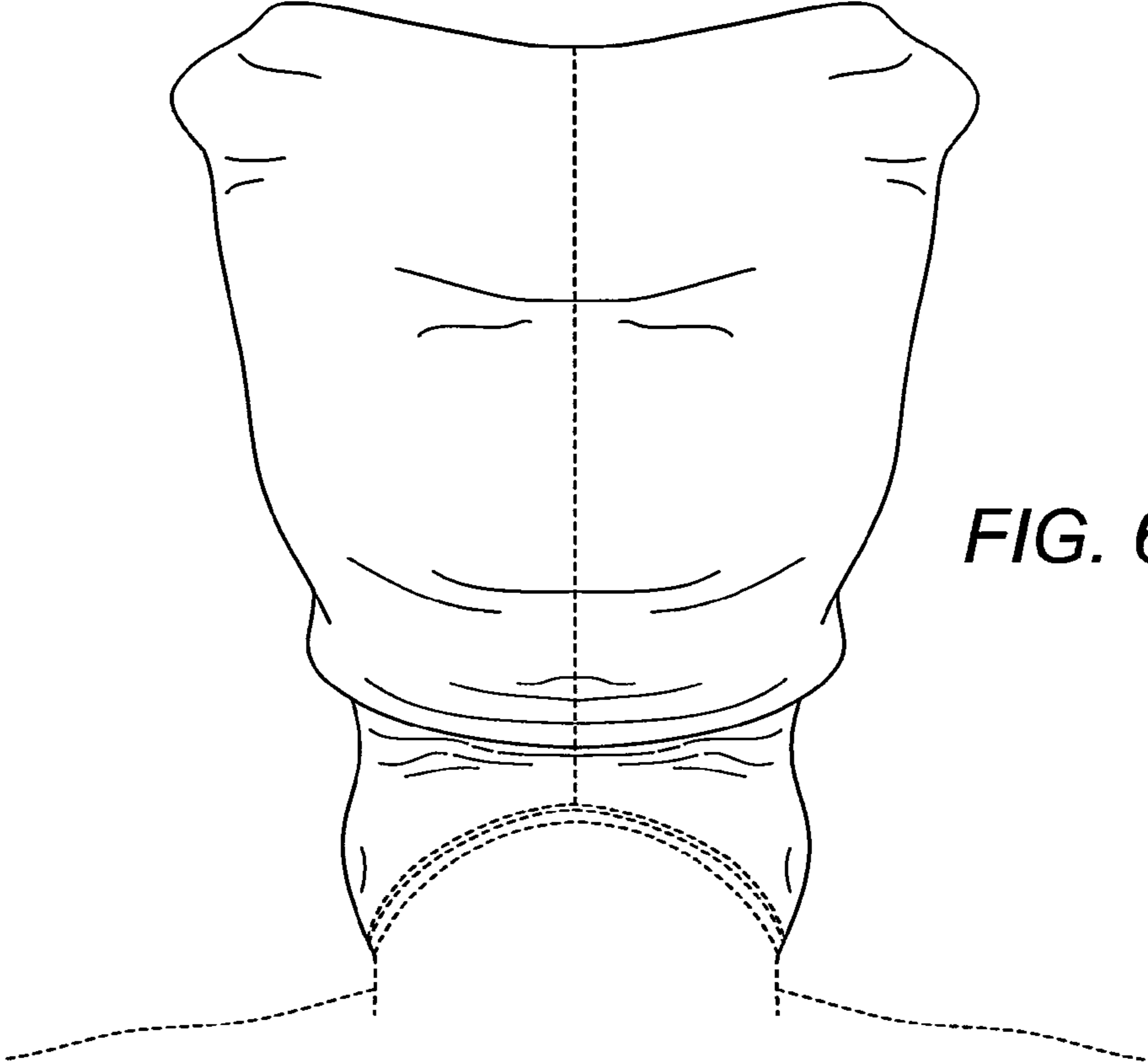
**FIG. 3**



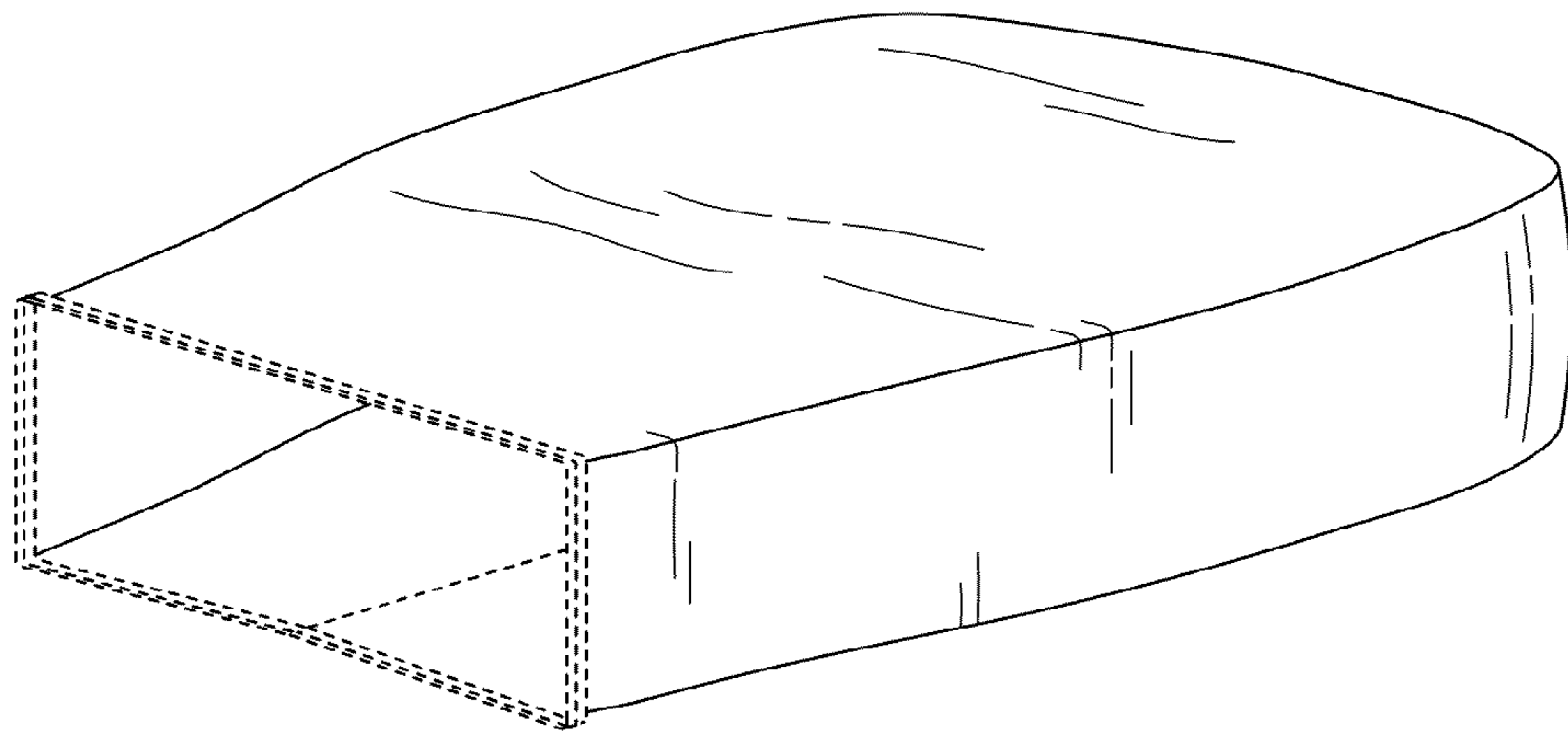
**FIG. 4**



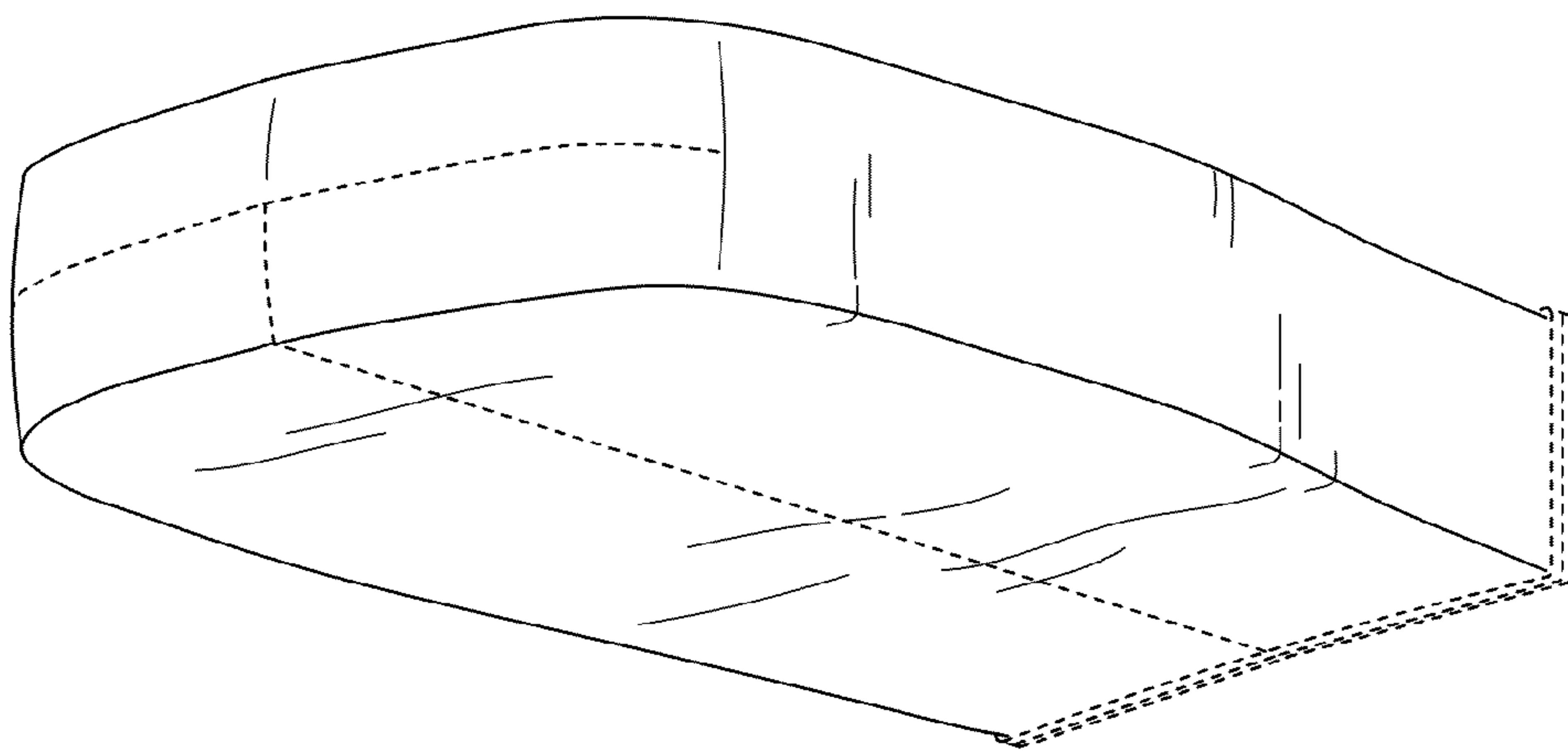
*FIG. 5*



*FIG. 6*



*FIG. 7*



*FIG. 8*

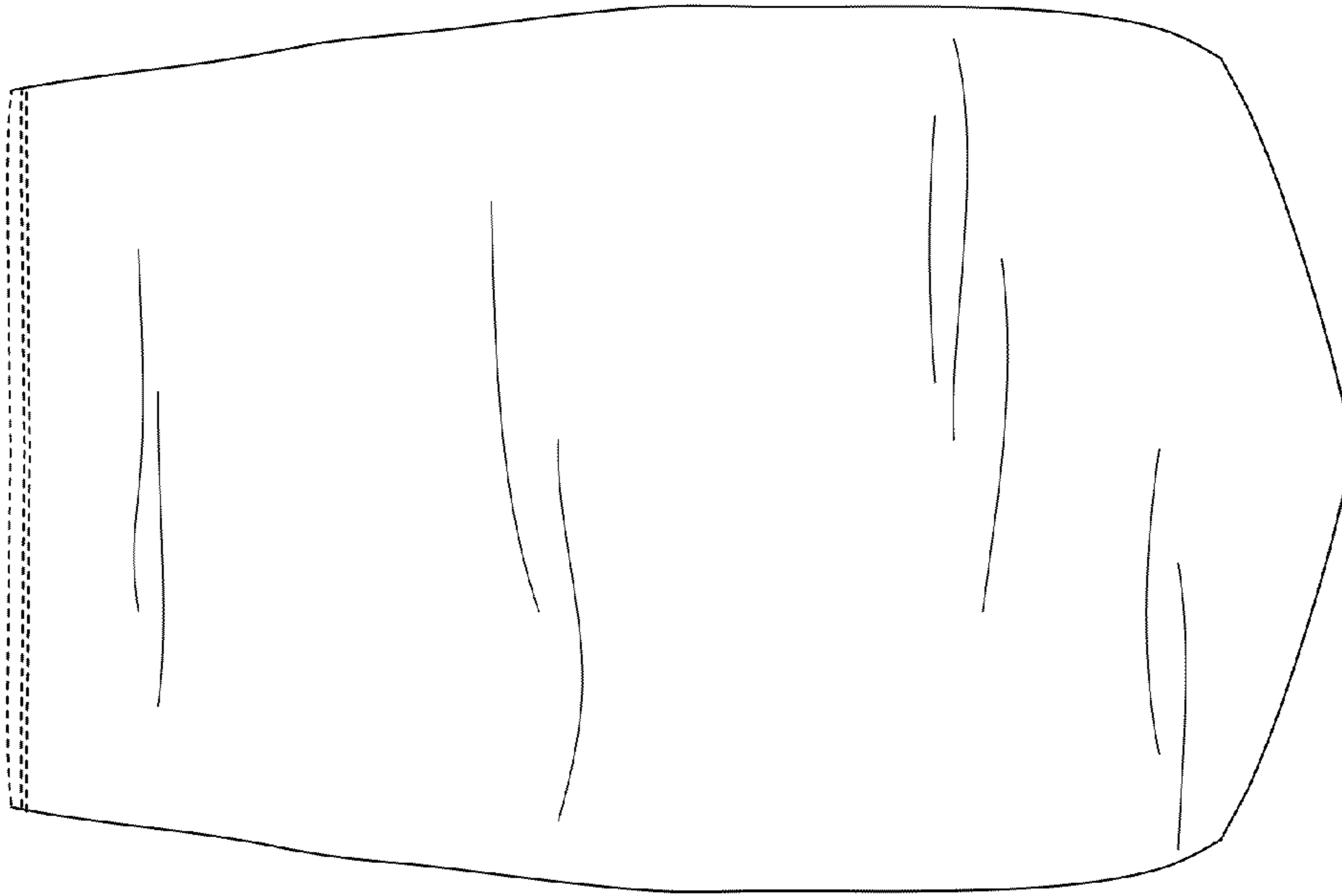


FIG. 9

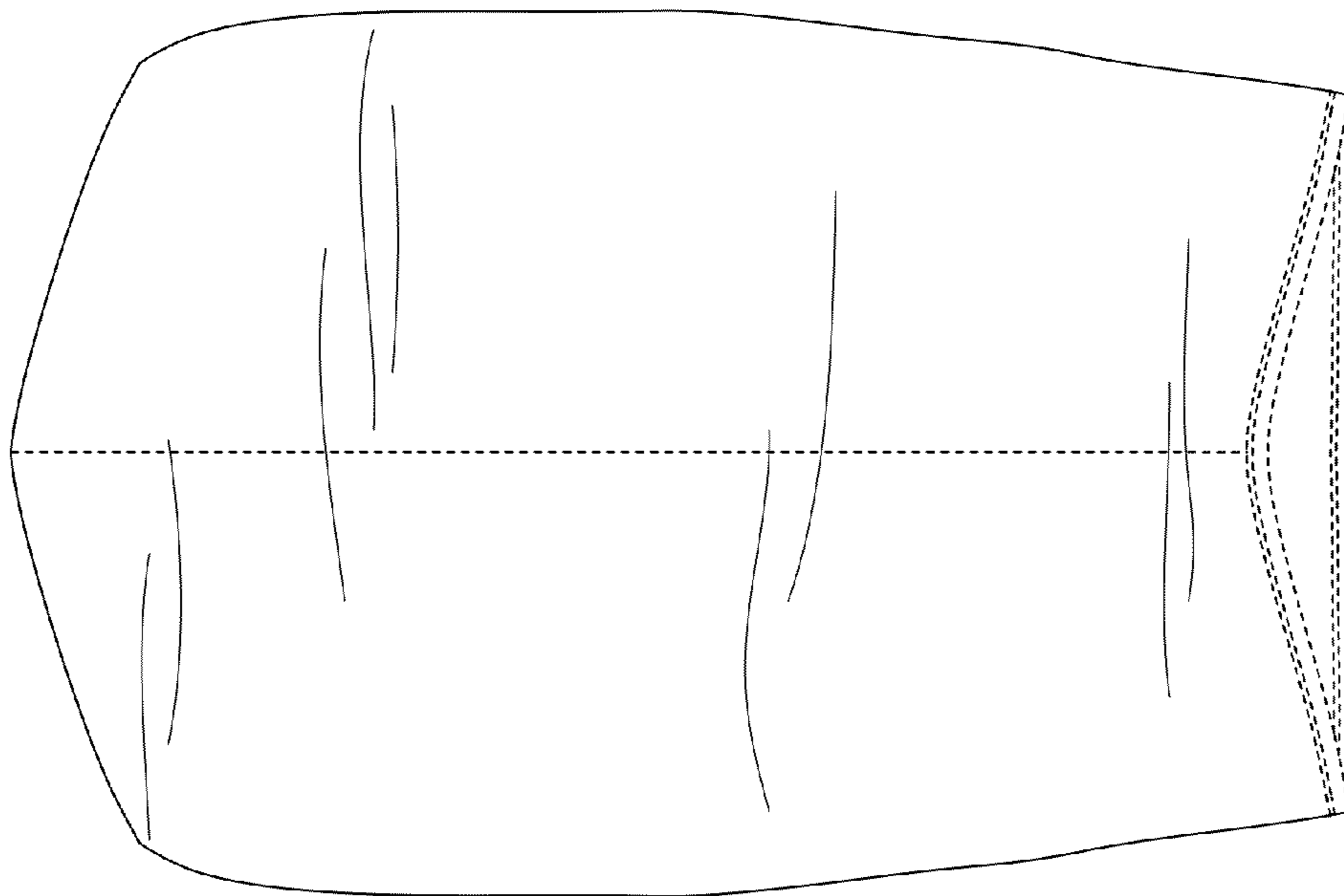
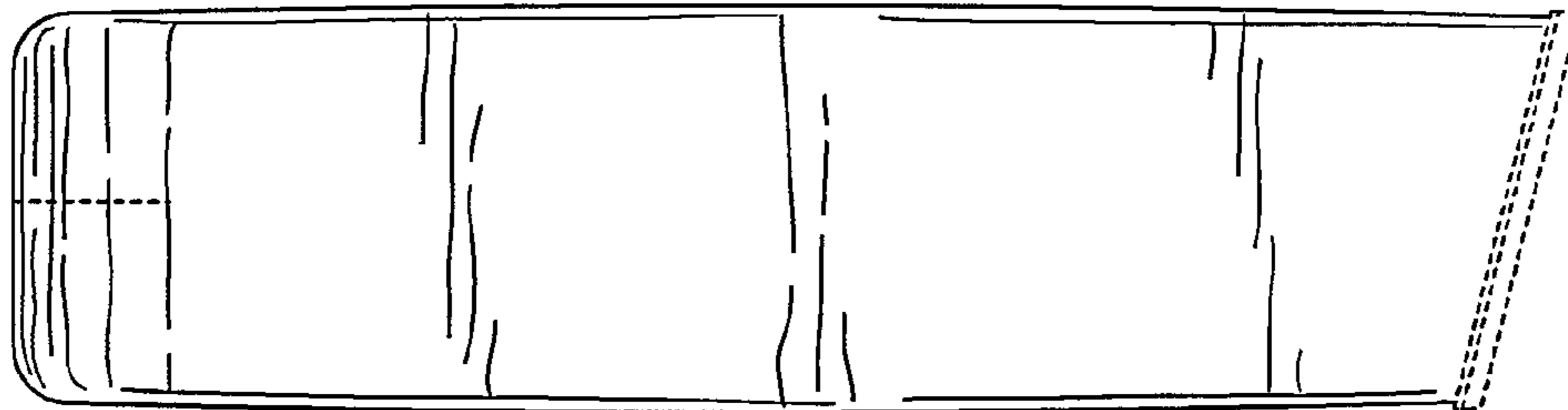
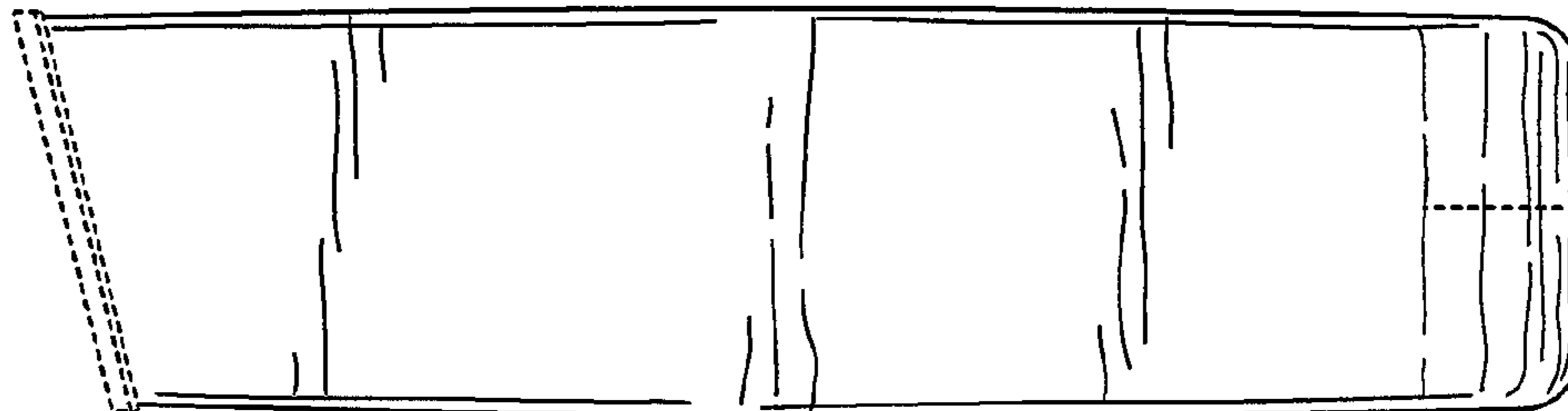


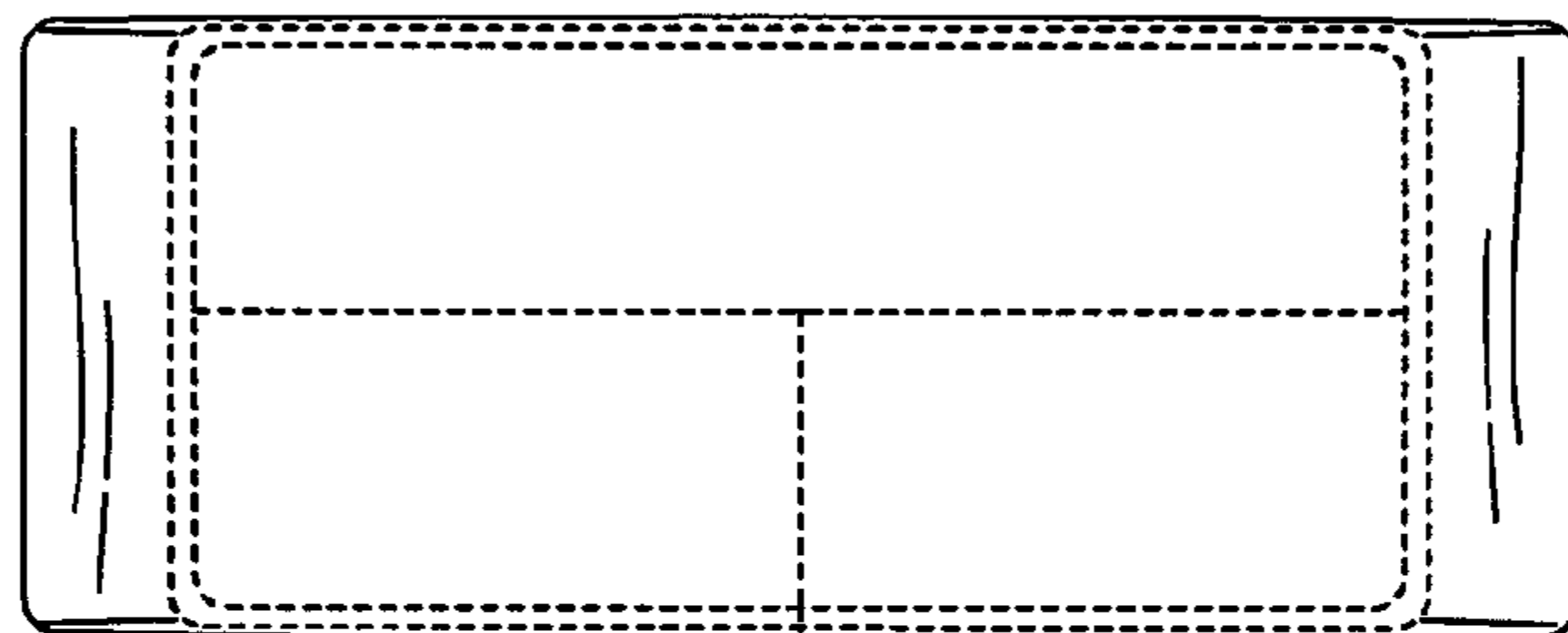
FIG. 10



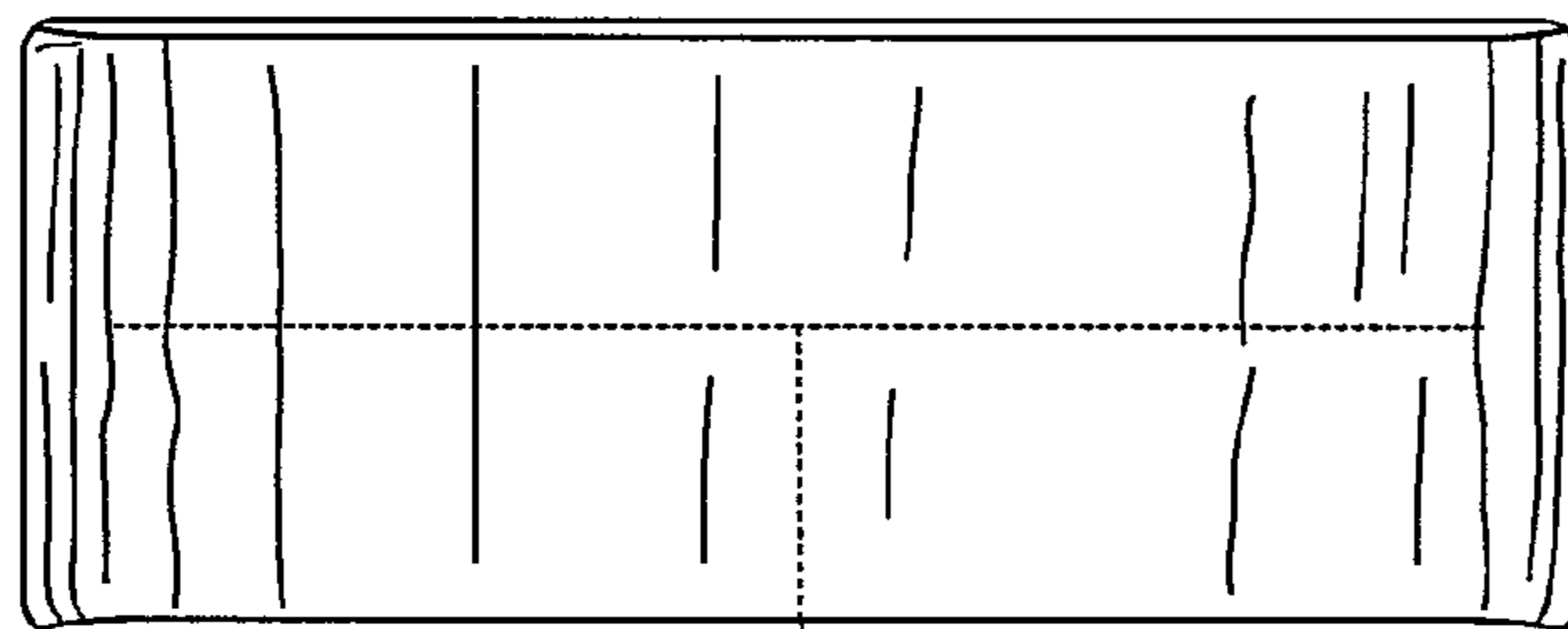
**FIG. 11**



**FIG. 12**



**FIG. 13**



**FIG. 14**