



US00D727589S

(12) **United States Design Patent**  
**Amato et al.**

(10) **Patent No.:** **US D727,589 S**

(45) **Date of Patent:** **\*\* Apr. 21, 2015**

(54) **MAILBOX**

(71) Applicants: **Michael John Amato**, Reston, VA (US);  
**Marc David McCrery**, Arlington, VA  
(US); **William Albert Tartal**, Baltimore,  
MD (US); **Donald Eugene Irwin**,  
Fredericksburg, VA (US); **Kelly Ann**  
**Strong**, Alexandria, VA (US)

(72) Inventors: **Michael John Amato**, Reston, VA (US);  
**Marc David McCrery**, Arlington, VA  
(US); **William Albert Tartal**, Baltimore,  
MD (US); **Donald Eugene Irwin**,  
Fredericksburg, VA (US); **Kelly Ann**  
**Strong**, Alexandria, VA (US)

(73) Assignee: **United States Postal Service**,  
Washington, DC (US)

(\*\*) Term: **14 Years**

(21) Appl. No.: **29/499,297**

(22) Filed: **Aug. 13, 2014**

(51) **LOC (10) Cl.** ..... **99-00**

(52) **U.S. Cl.**  
USPC ..... **D99/29**

(58) **Field of Classification Search**  
USPC ..... D99/28, 29, 30, 31, 32, 33, 43, 99;  
D20/6; 312/35; 232/1 R, 1 A, 1 C, 1 D,  
232/4 R, 2, 17, 19, 20, 21, 22, 24, 27, 30,  
232/31, 37, 38, 39, 44, 45  
See application file for complete search history.

(56) **References Cited**

**U.S. PATENT DOCUMENTS**

936,215	A *	10/1909	Broberg	232/35
1,195,016	A *	8/1916	Hillman	232/34
1,564,073	A *	12/1925	Johnson	232/17
2,249,731	A *	7/1941	Gilstrap	292/74
2,669,408	A *	2/1954	Cox	248/146

D183,625	S *	9/1958	Masso	D99/29
3,981,413	A *	9/1976	Cornwell, Jr.	220/845
4,368,842	A *	1/1983	DeLange, III	232/17
4,413,770	A *	11/1983	Nye	232/17
4,491,268	A *	1/1985	Faulkingham	232/35
4,712,731	A *	12/1987	Gramelspacher	232/17
4,950,202	A *	8/1990	Florio	446/219
D315,821	S *	3/1991	Lorenzi	D99/29
D385,677	S *	10/1997	Vivirito, Jr.	D99/29
D445,988	S *	7/2001	Gaines et al.	D99/29
D476,791	S *	7/2003	South	D99/29
D477,449	S *	7/2003	South	D99/29
D477,450	S *	7/2003	South	D99/29
D480,199	S *	9/2003	Dineen	D99/29
D482,178	S *	11/2003	South	D99/29
D482,179	S *	11/2003	South	D99/29
D485,418	S *	1/2004	Cano	D99/29
6,729,535	B2 *	5/2004	Lackey et al.	232/17
D493,937	S *	8/2004	Dillilo et al.	D99/29
D563,625	S *	3/2008	Bowers	D99/29
D617,975	S *	6/2010	Koslak	D99/31

\* cited by examiner

*Primary Examiner* — Elizabeth J Oswecki

(74) *Attorney, Agent, or Firm* — Finnegan, Henderson,  
Farabow, Garrett & Dunner LLP

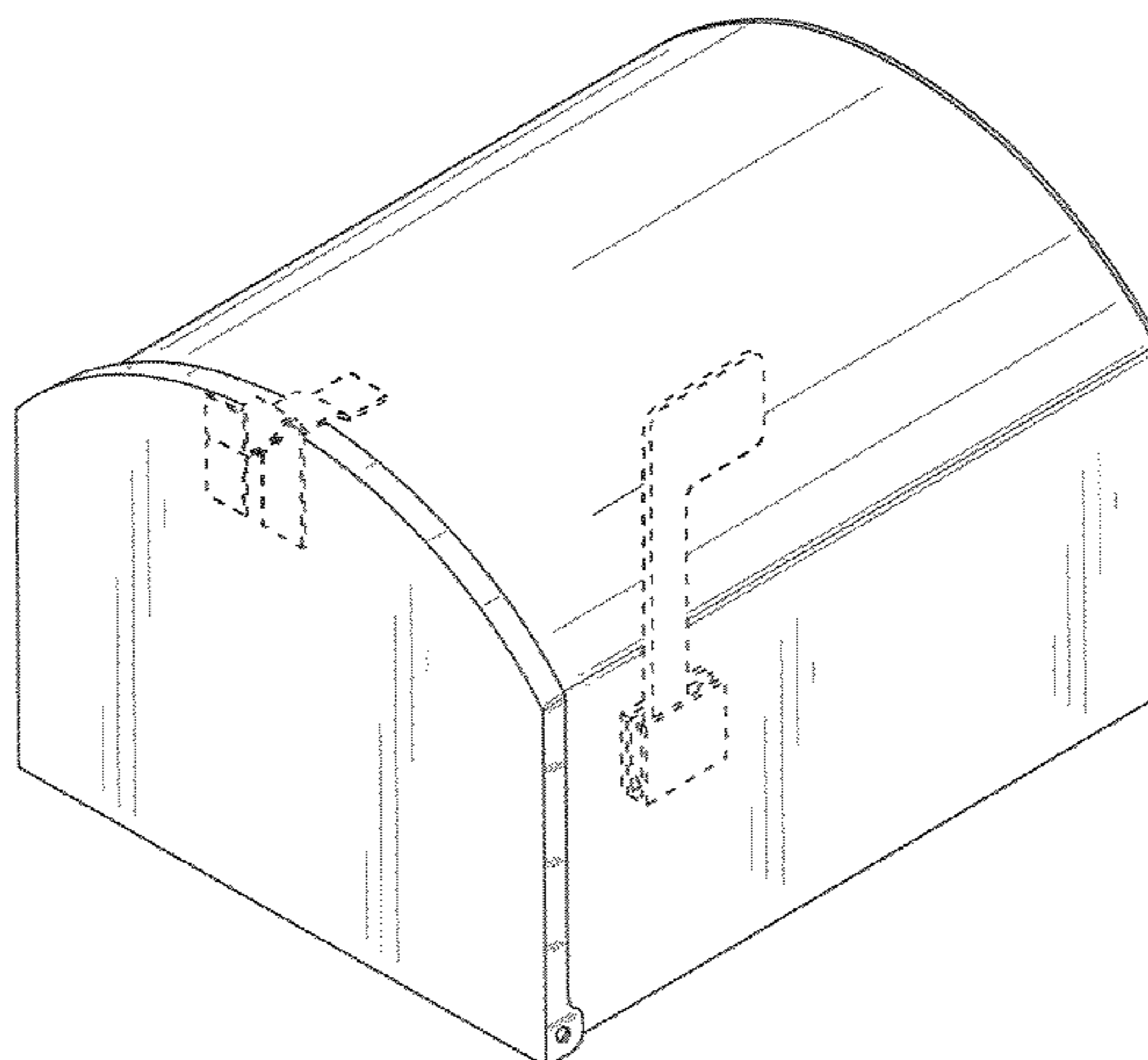
(57) **CLAIM**

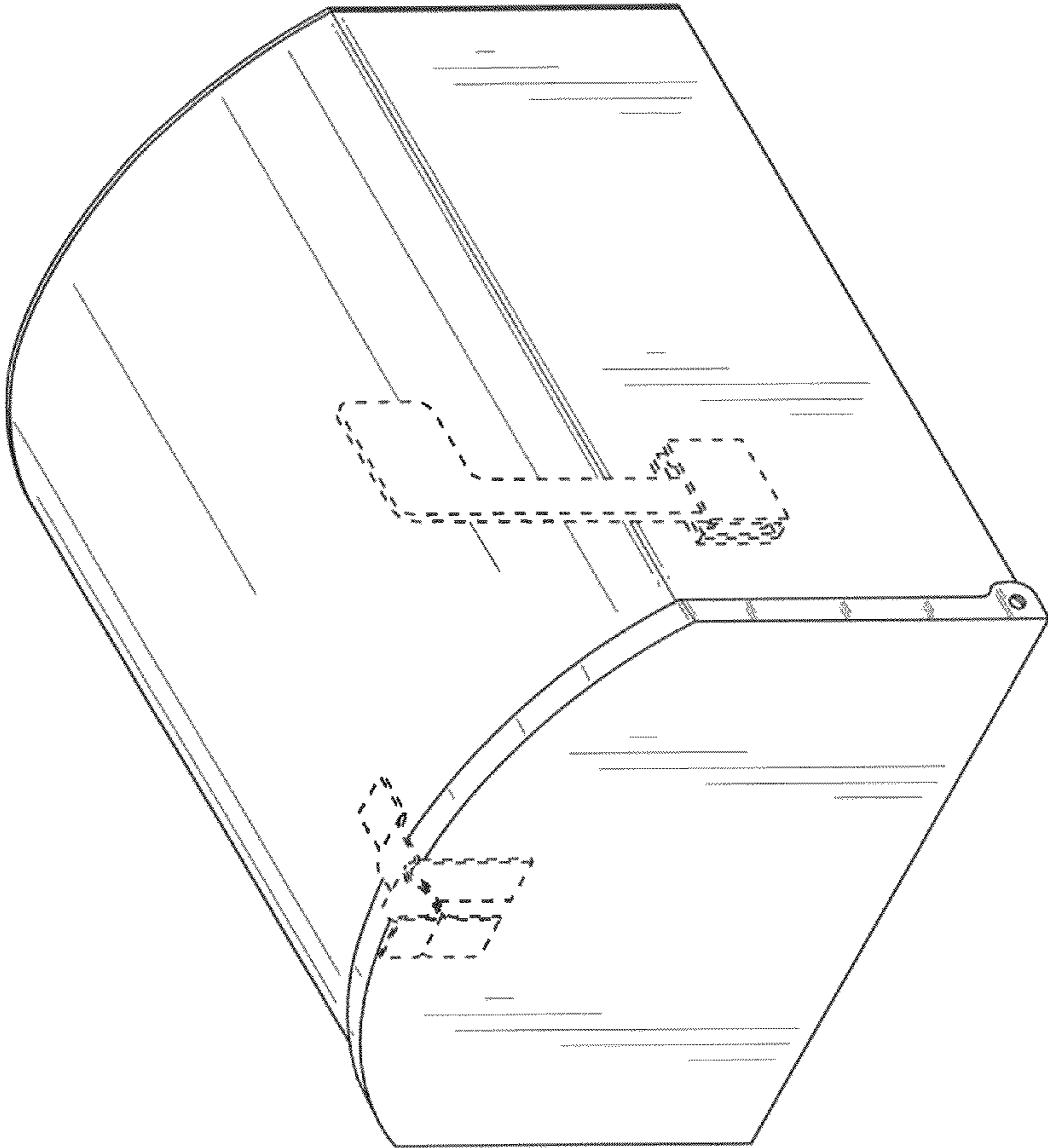
The ornamental design for a mailbox, as shown and described.

**DESCRIPTION**

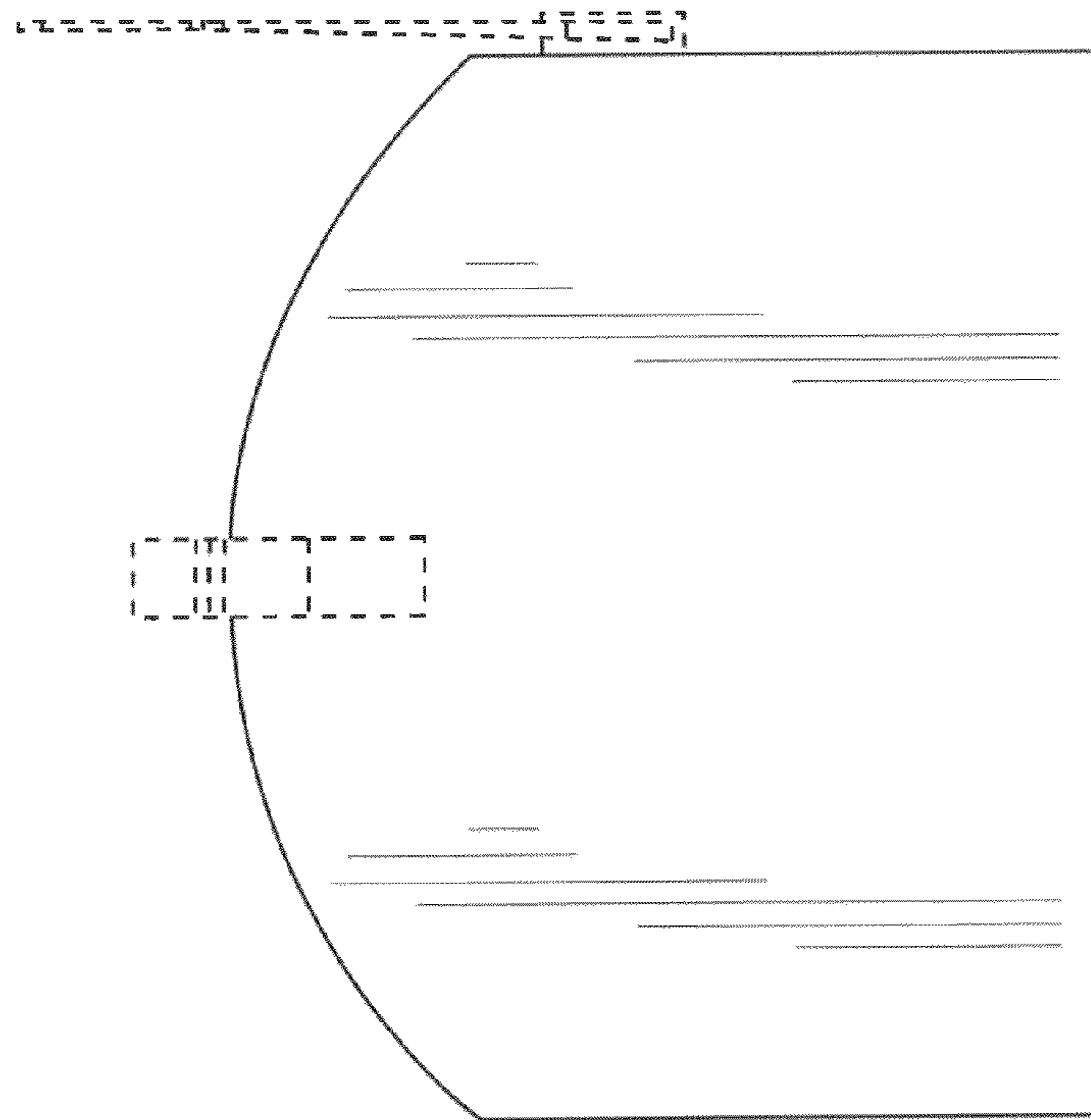
FIG. 1 is a top, right, front, perspective view of a mailbox showing our new design;  
FIG. 2 is a front elevation view thereof;  
FIG. 3 is a rear elevation view thereof;  
FIG. 4 is a left side elevation view thereof;  
FIG. 5 is a right side elevation view thereof;  
FIG. 6 is a top plan view thereof; and,  
FIG. 7 is a bottom plan view thereof.  
The broken lines shown in the drawings represent portions of the mailbox that form no part of the claimed design.

**1 Claim, 7 Drawing Sheets**

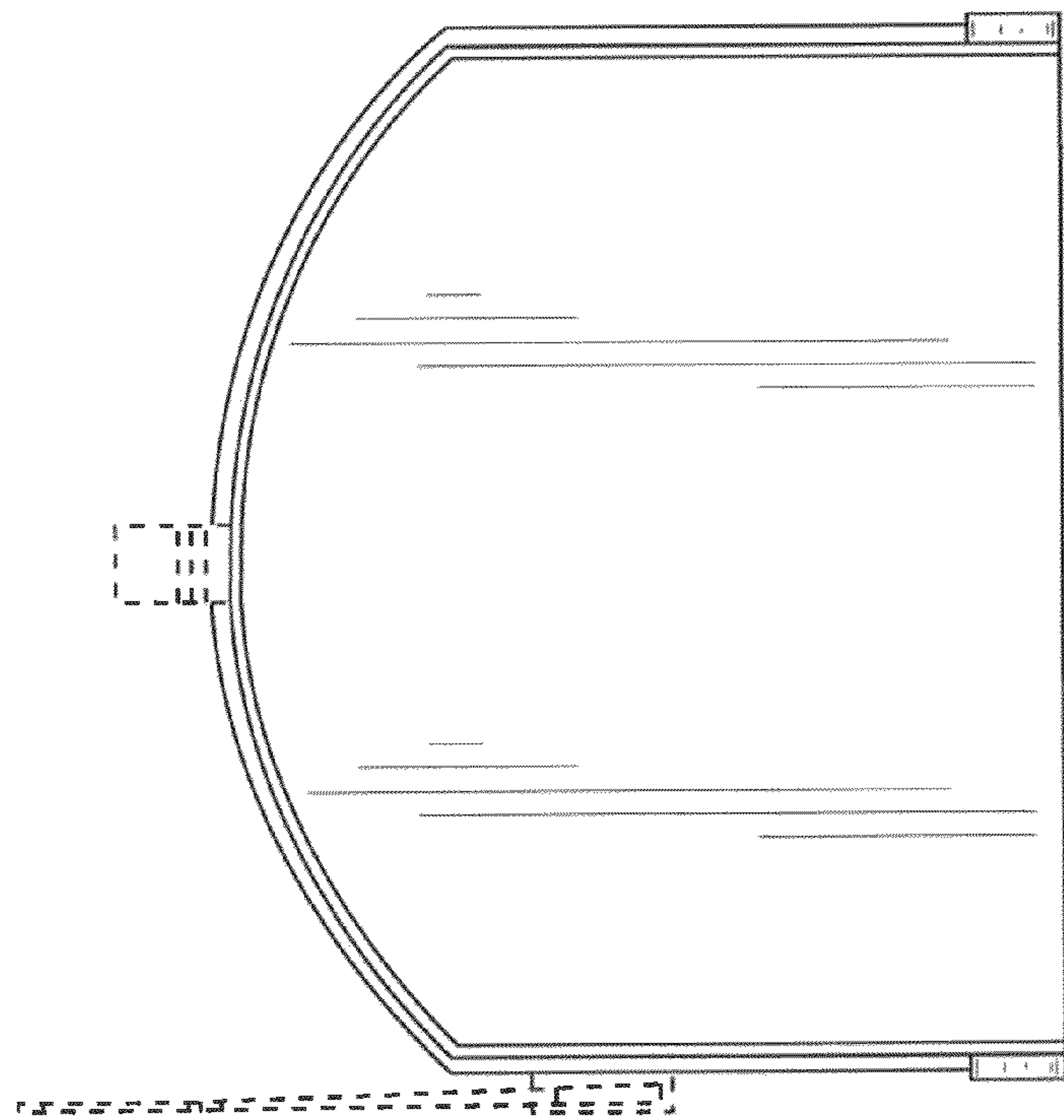




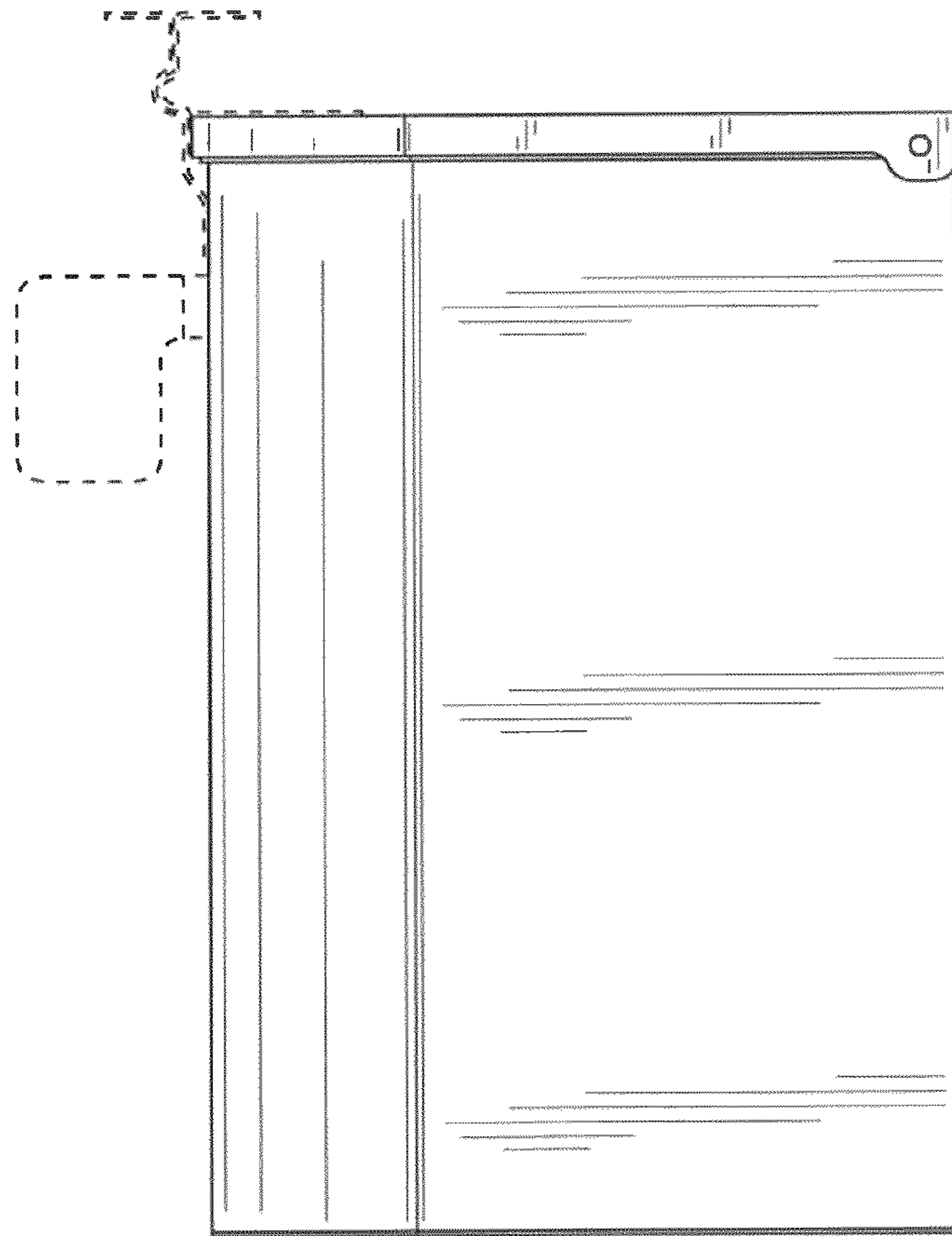
**FIG. 1**



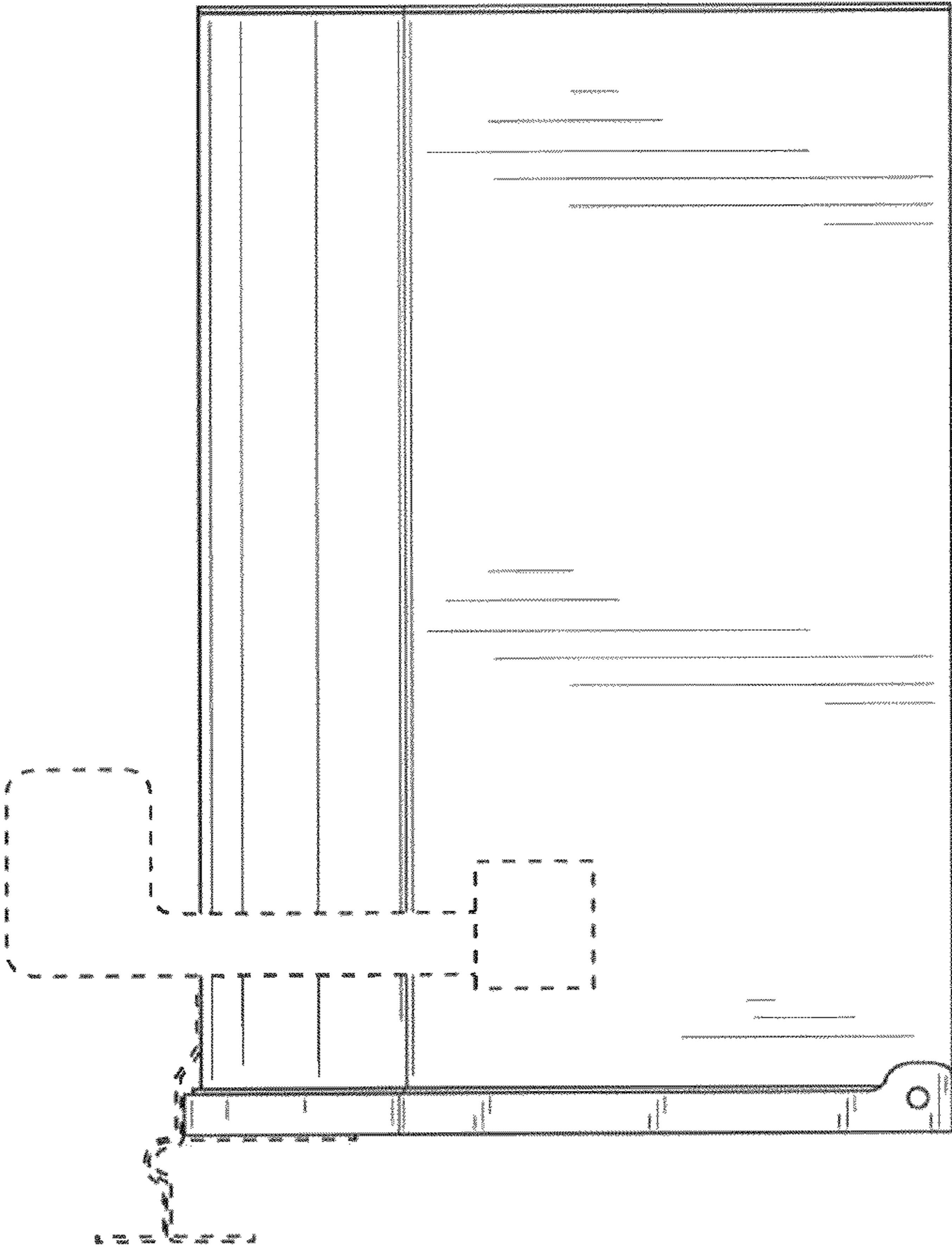
**FIG. 2**



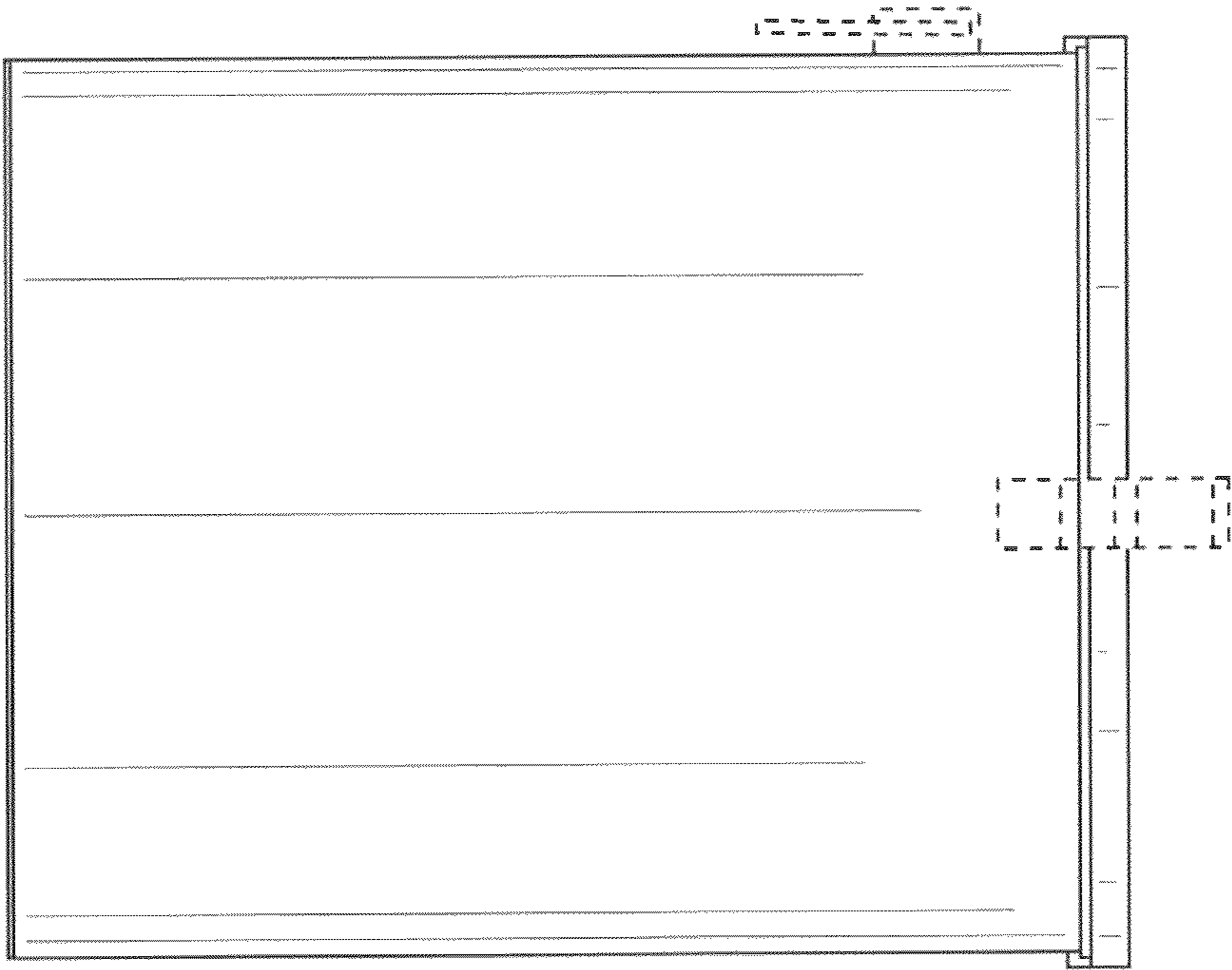
**FIG. 3**



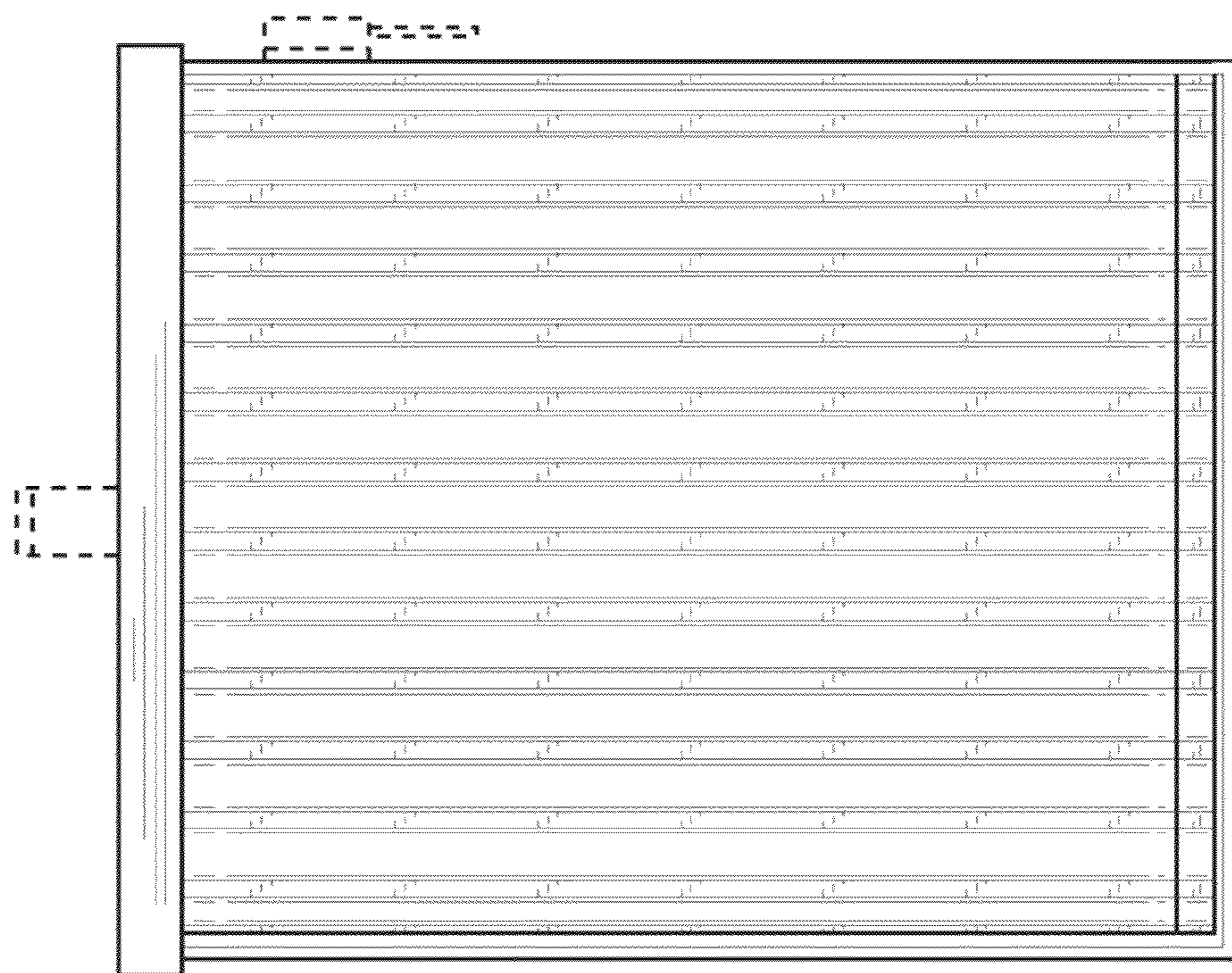
**FIG. 4**



**FIG. 5**



**FIG. 6**



**FIG. 7**