



US00D727588S

(12) **United States Design Patent**
Kemper, Sr.

(10) **Patent No.:** **US D727,588 S**
(45) **Date of Patent:** **** Apr. 21, 2015**

(54) **CASKET**

(71) Applicant: **Robert Arnold Kemper, Sr.**, Grove City, OH (US)

(72) Inventor: **Robert Arnold Kemper, Sr.**, Grove City, OH (US)

(**) Term: **14 Years**

(21) Appl. No.: **29/476,575**

(22) Filed: **Dec. 15, 2013**

(51) **LOC (10) Cl.** **99-00**

(52) **U.S. Cl.**
USPC **D99/1**

(58) **Field of Classification Search**
CPC A61G 17/00
USPC D99/3, 1, 4, 5; 52/103; D9/428, 414, D9/420; D16/135, 137; D24/101; 510/141; D28/5, 8.1; 27/1, 2, 5, 6, 35
See application file for complete search history.

(56) **References Cited**

U.S. PATENT DOCUMENTS

462,990	A *	11/1891	Oppenheimer	424/451
636,603	A *	11/1899	Williams	27/8
636,608	A *	11/1899	Williams	278/96.2
1,197,810	A *	9/1916	Flack	52/104
1,686,048	A *	10/1928	Thompson	27/30

(Continued)

Primary Examiner — Paula Greene

(74) *Attorney, Agent, or Firm* — The Law Office of Patrick F. O'Reilly III, LLC

(57) **CLAIM**

The ornamental design for a casket, as shown and described.

DESCRIPTION

FIG. 1 is a top-front perspective view of a casket showing my new design;

FIG. 2 is a bottom-front perspective view thereof;
 FIG. 3 is a front side elevational view thereof;
 FIG. 4 is a left side elevational view thereof;
 FIG. 5 is a rear side elevational view thereof;
 FIG. 6 is a right side elevational view thereof;
 FIG. 7 is a top plan view thereof;
 FIG. 8 is a bottom plan view thereof;
 FIG. 9 is another top-front perspective view thereof, wherein the casket is illustrated together with a carrying tray disposed therebelow, the carrying tray shown in broken lines forms no part of the claimed invention;
 FIG. 10 is another bottom-front perspective view thereof, wherein the casket is illustrated together with the carrying tray disposed therebelow, the carrying tray shown in broken lines forms no part of the claimed invention;
 FIG. 11 is a front side elevational view thereof, wherein the casket is illustrated together with the carrying tray disposed therebelow, the carrying tray shown in broken lines forms no part of the claimed invention;
 FIG. 12 is a left side elevational view thereof, wherein the casket is illustrated together with the carrying tray disposed therebelow, the carrying tray shown in broken lines forms no part of the claimed invention;
 FIG. 13 is a rear side elevational view thereof, wherein the casket is illustrated together with the carrying tray disposed therebelow, the carrying tray shown in broken lines forms no part of the claimed invention;
 FIG. 14 is a right side elevational view thereof, wherein the casket is illustrated together with the carrying tray disposed therebelow, the carrying tray shown in broken lines forms no part of the claimed invention;
 FIG. 15 is a top plan view thereof, wherein the casket is illustrated together with the carrying tray disposed therebelow, the carrying tray shown in broken lines forms no part of the claimed invention; and,
 FIG. 16 is a bottom plan view thereof, wherein the casket is illustrated together with the carrying tray disposed therebelow, the carrying tray shown in broken lines forms no part of the claimed invention.

The broken line portions of the drawing figures are included to show unclaimed subject matter only and form no part of the claimed design.

1 Claim, 12 Drawing Sheets

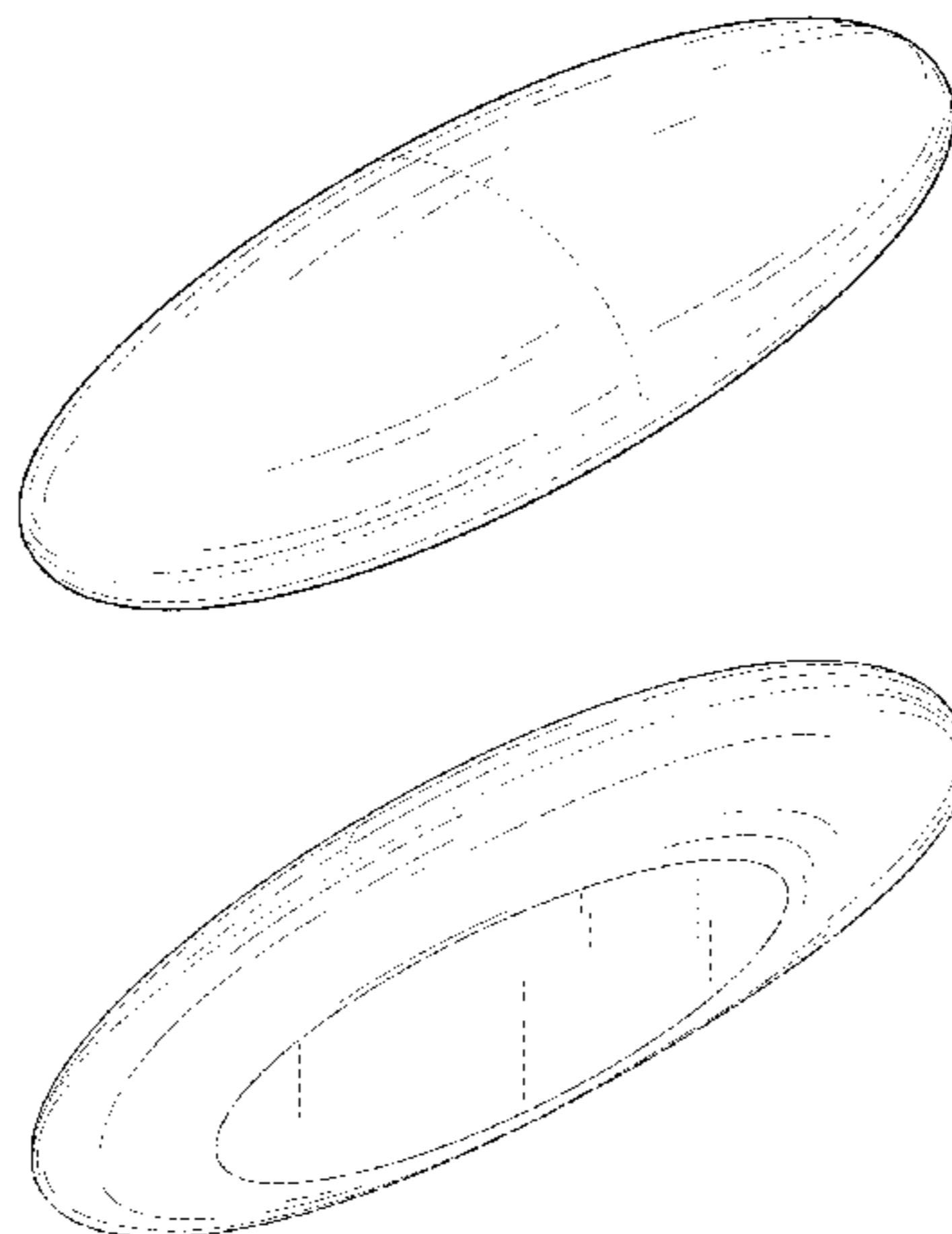

(56)

References Cited

U.S. PATENT DOCUMENTS

2,570,361 A * 10/1951 Mejia 27/1
 2,586,581 A * 2/1952 Tschischeck 359/442
 2,811,768 A * 11/1957 Axelson 27/7
 D183,984 S 11/1958 Volkel
 D188,458 S 7/1960 Flynn
 D189,136 S * 11/1960 Wahl D99/3
 3,172,183 A * 3/1965 Bugg 27/7
 D207,039 S * 2/1967 Sillett D28/8.1
 3,348,280 A * 10/1967 Myers 27/2
 D227,758 S * 7/1973 Brady D3/272
 D243,455 S * 2/1977 Verini D23/205
 4,743,248 A * 5/1988 Bartoo et al. 604/892.1
 D328,176 S * 7/1992 Ruble D99/3
 5,127,112 A * 7/1992 Brock 27/1
 5,217,639 A * 6/1993 Mottola 510/146

5,222,281 A 6/1993 Guerin
 5,314,696 A * 5/1994 Paulos 424/453
 D375,258 S * 11/1996 Weder et al. D9/414
 5,659,932 A * 8/1997 Wright 27/7
 5,680,682 A 10/1997 Watkins et al.
 D386,007 S * 11/1997 Eckhardt D6/300
 D406,187 S * 3/1999 Garcia-Gutierrez D1/199
 D445,674 S * 7/2001 Pritchett D9/707
 D528,733 S * 9/2006 Spiegel D99/1
 D583,125 S 12/2008 Hubbard
 D593,725 S 6/2009 Schultz et al.
 7,703,186 B1 * 4/2010 Williamson 27/2
 D620,222 S 7/2010 Schultz et al.
 D672,934 S * 12/2012 Salomon et al. D99/1
 D676,605 S * 2/2013 Marden D28/59
 D700,765 S * 3/2014 Goldstein D99/5
 D711,063 S * 8/2014 Kemble D99/1

* cited by examiner

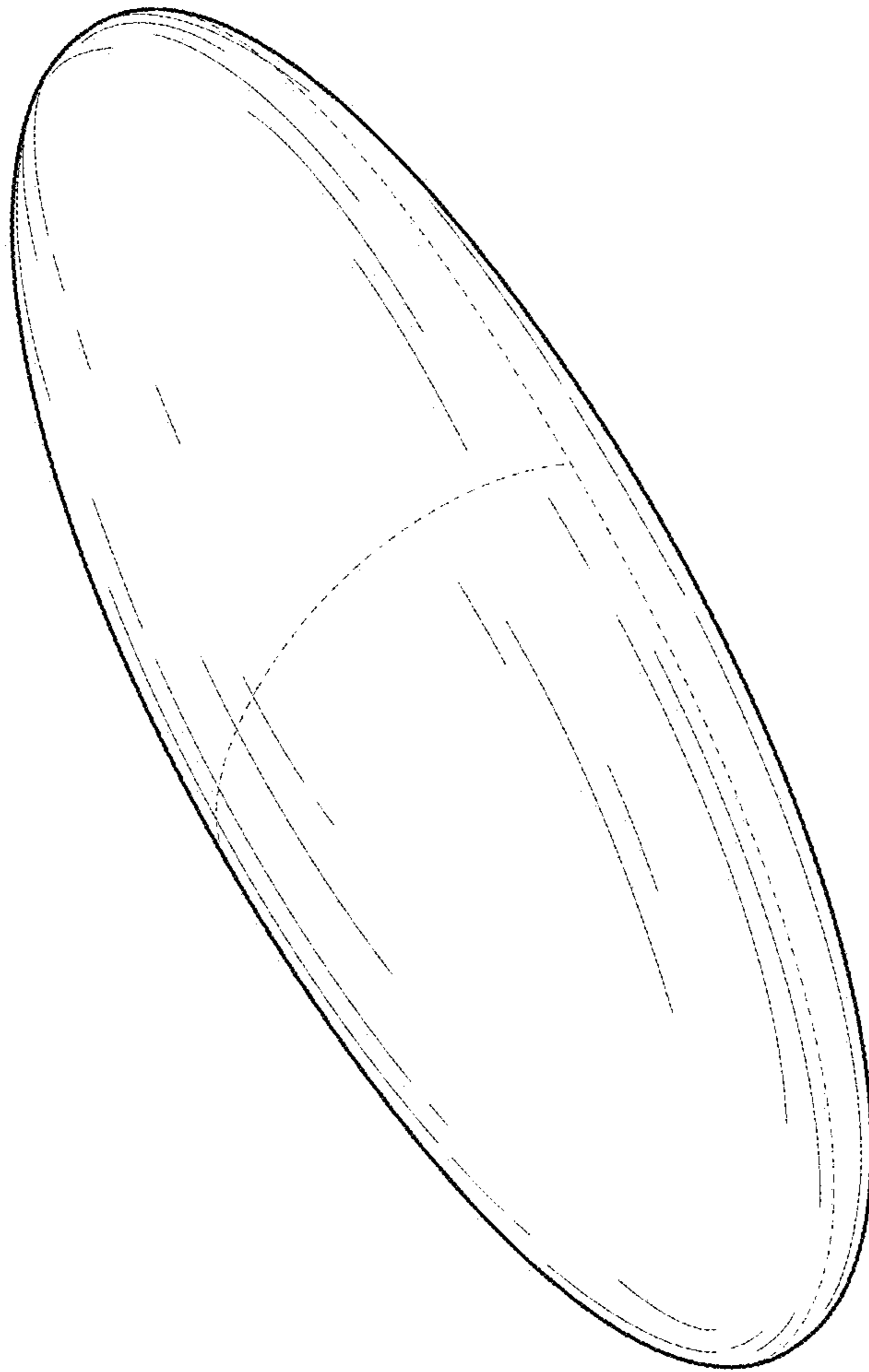

FIG. 1

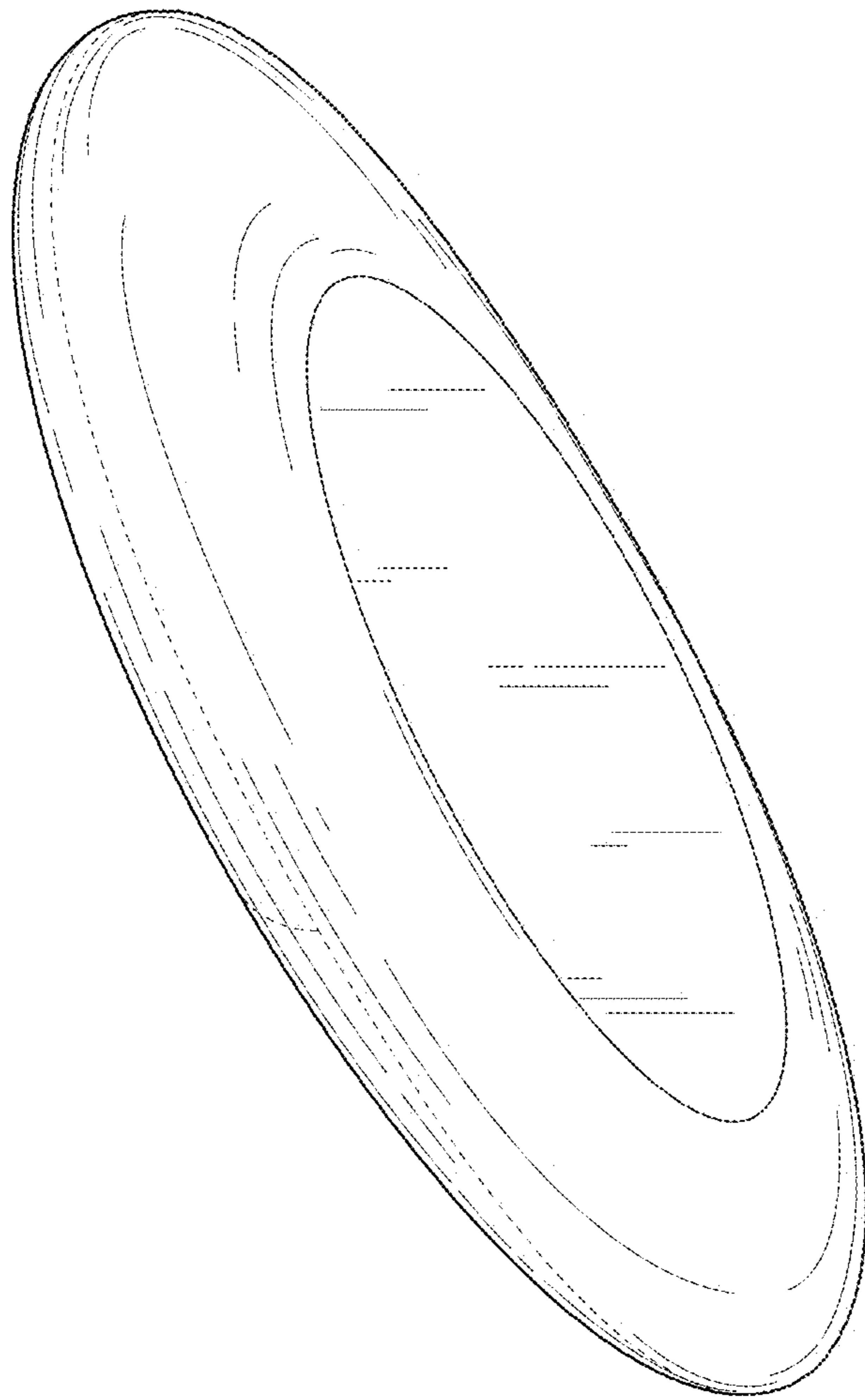

FIG. 2

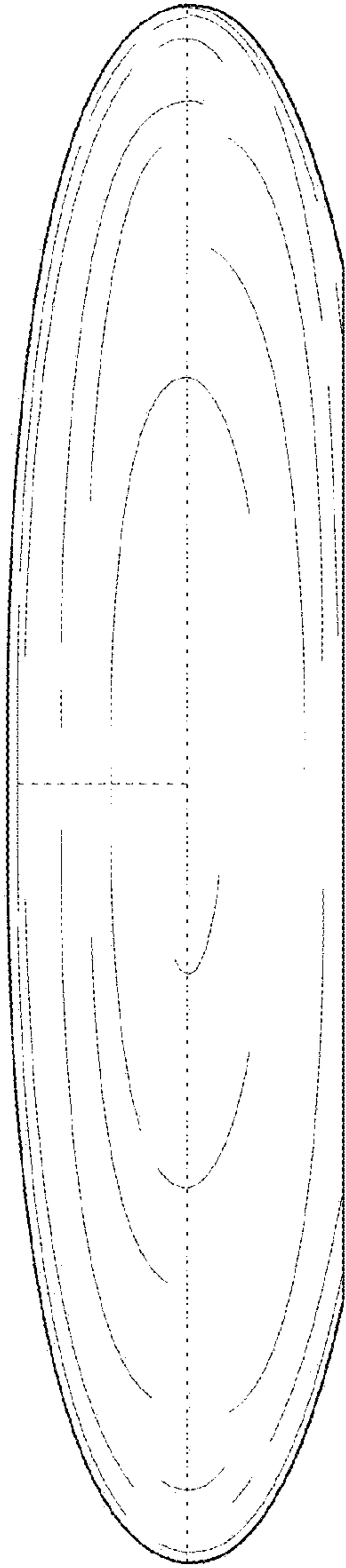

FIG. 3

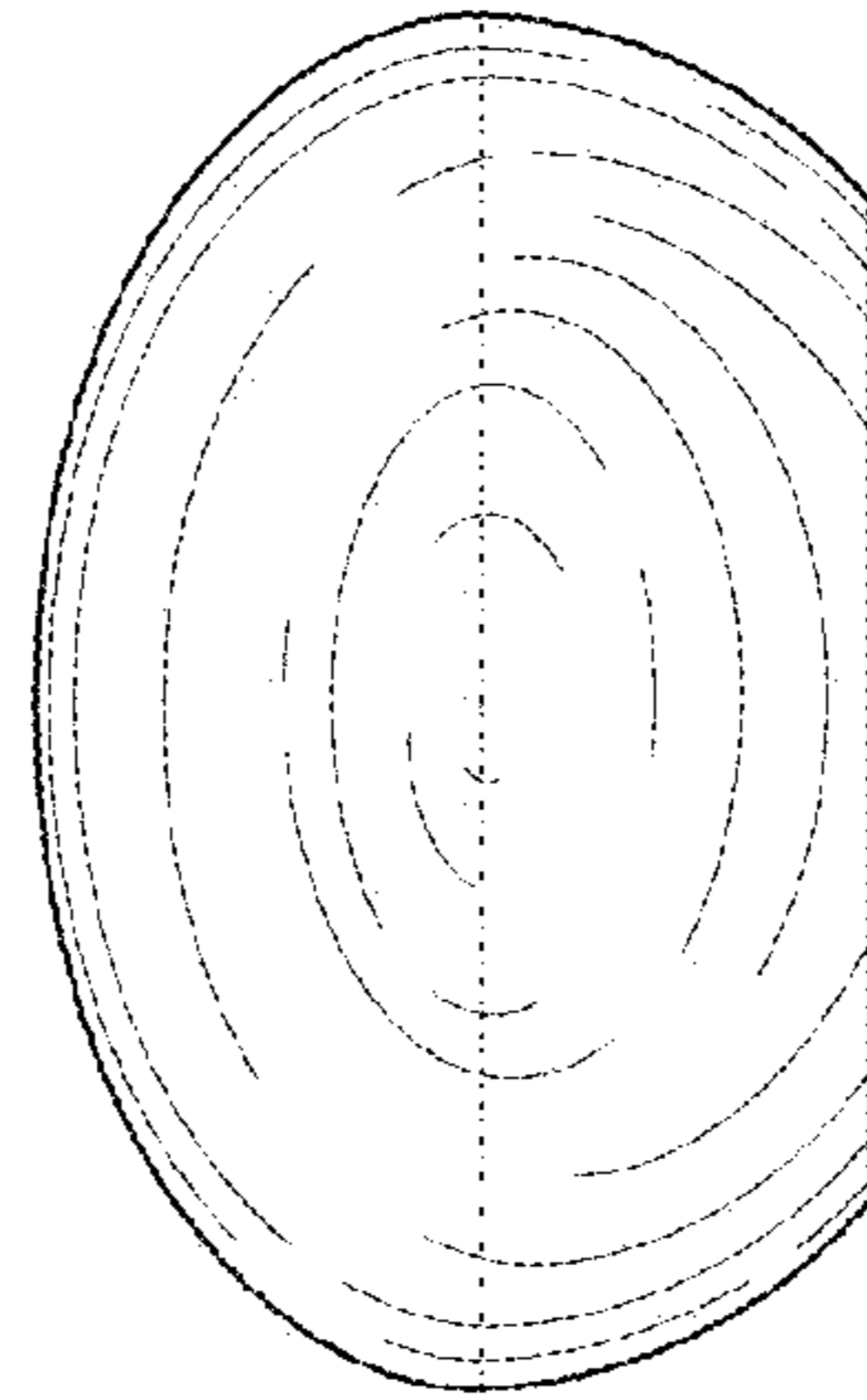

FIG. 4

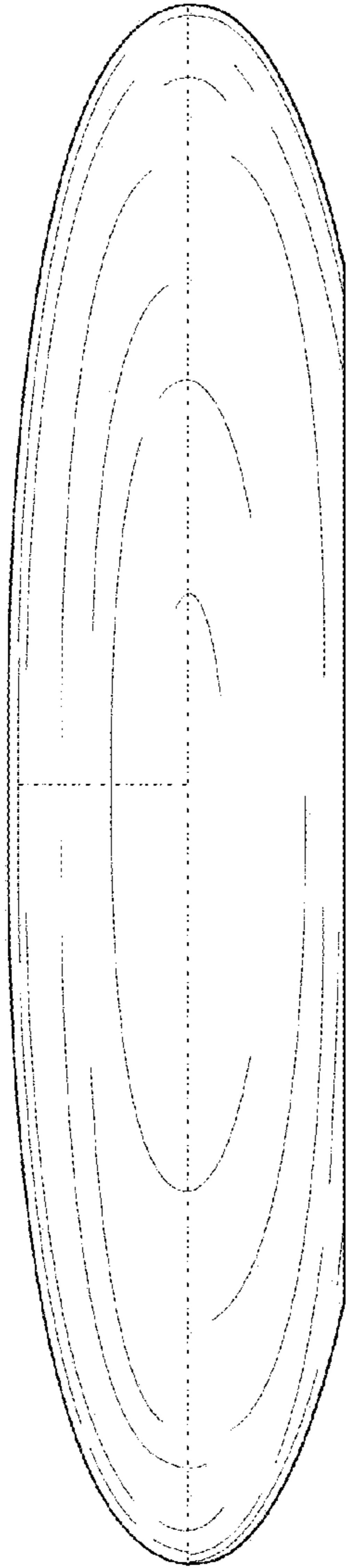

FIG. 5

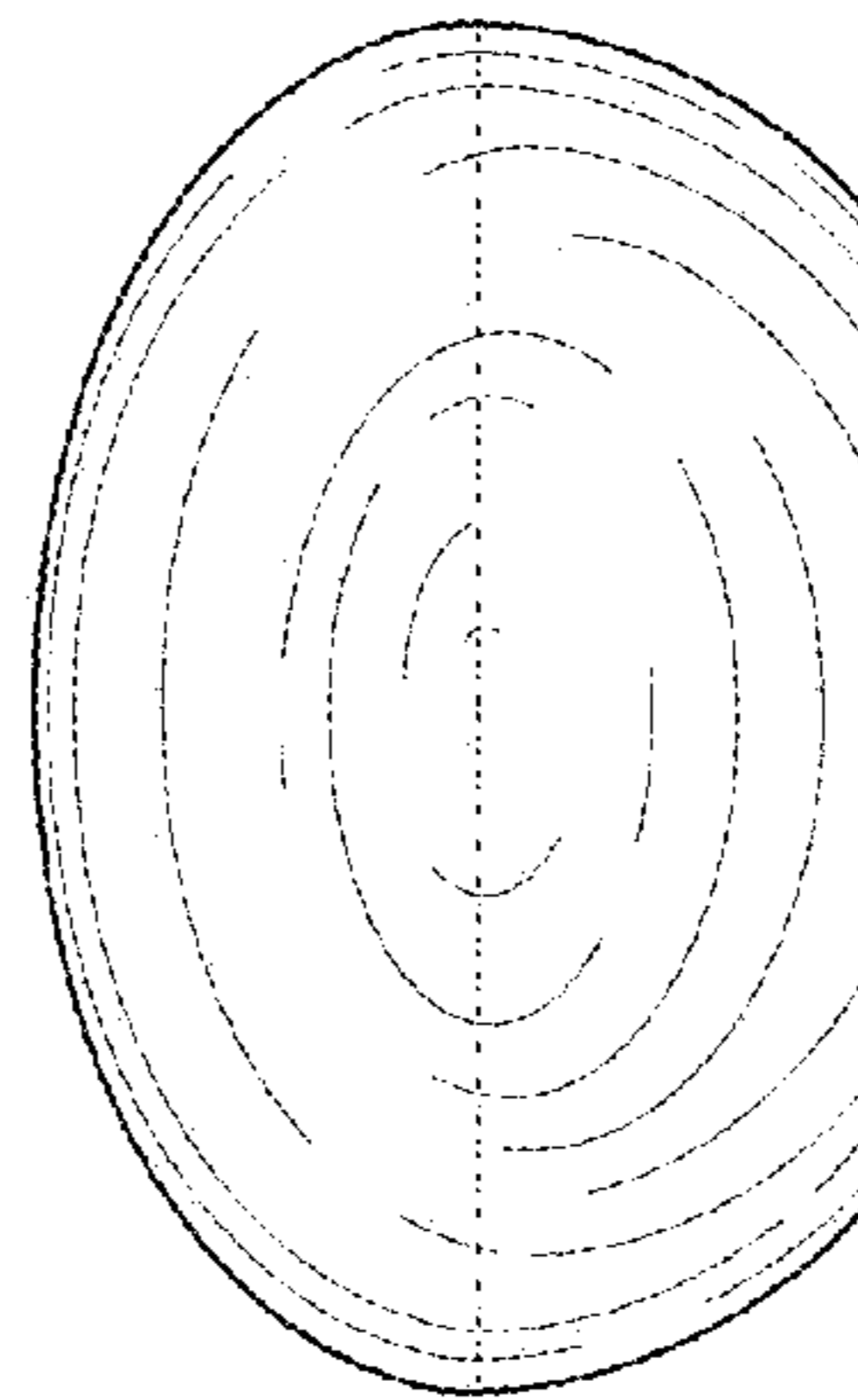

FIG. 6

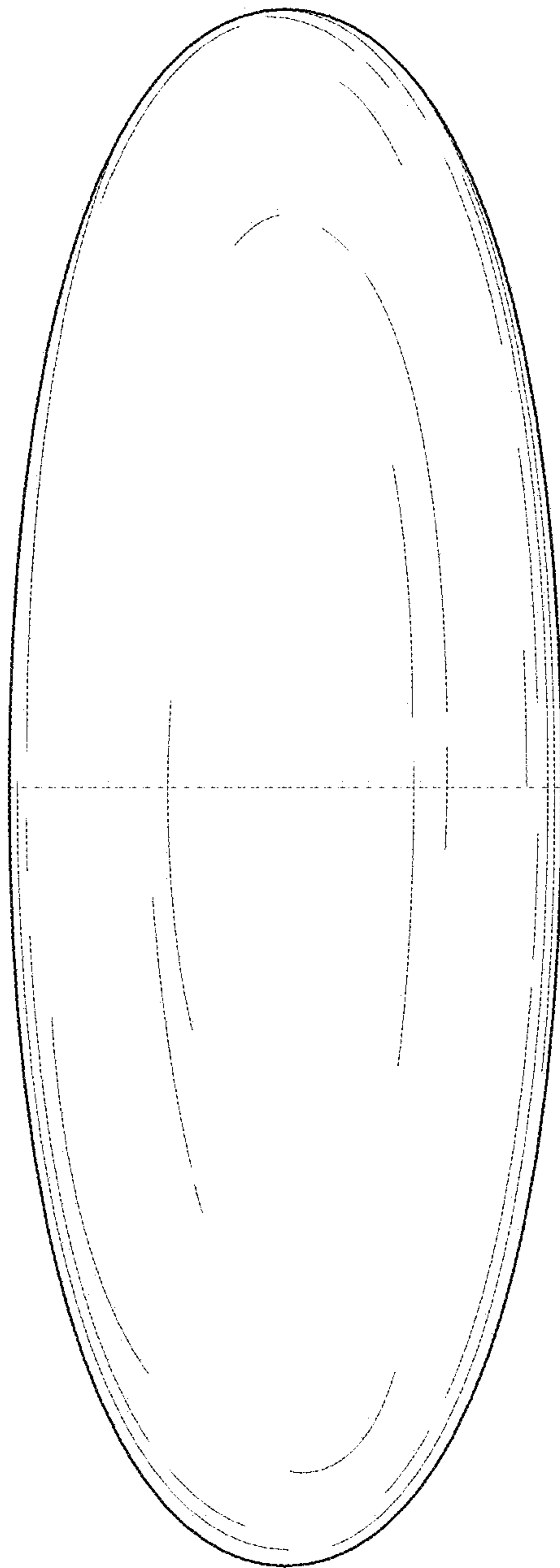

FIG. 7

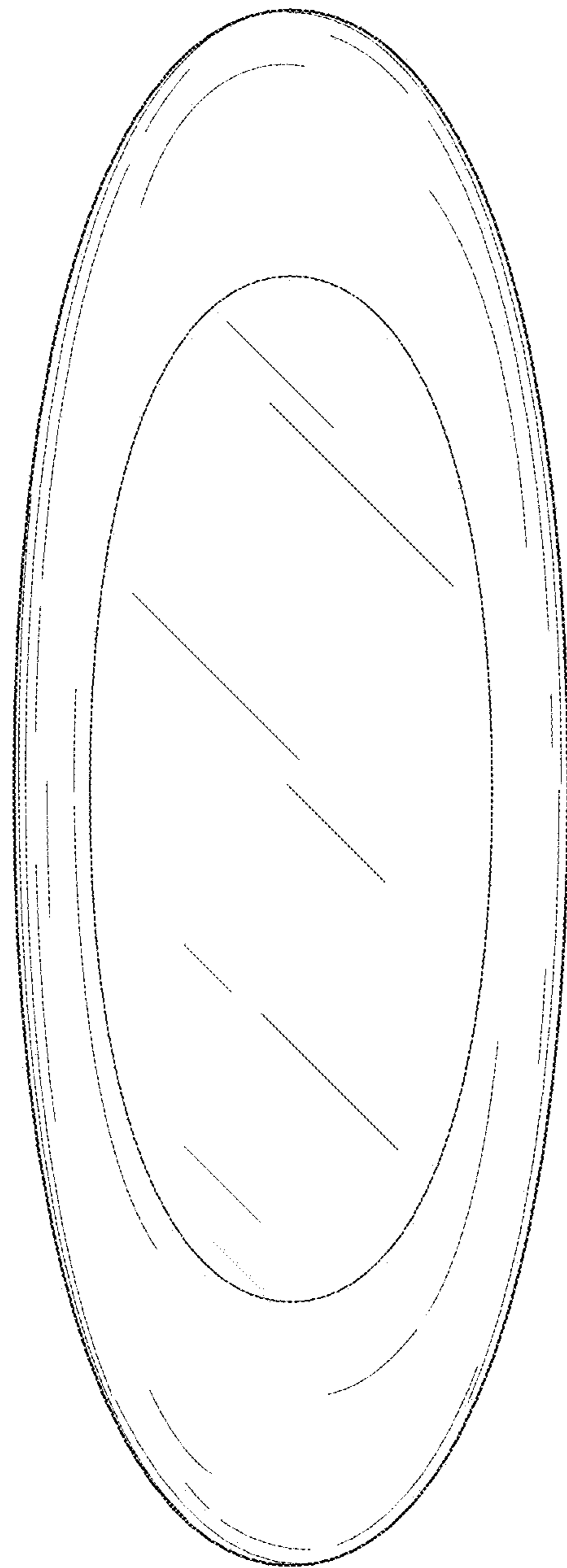

FIG. 8

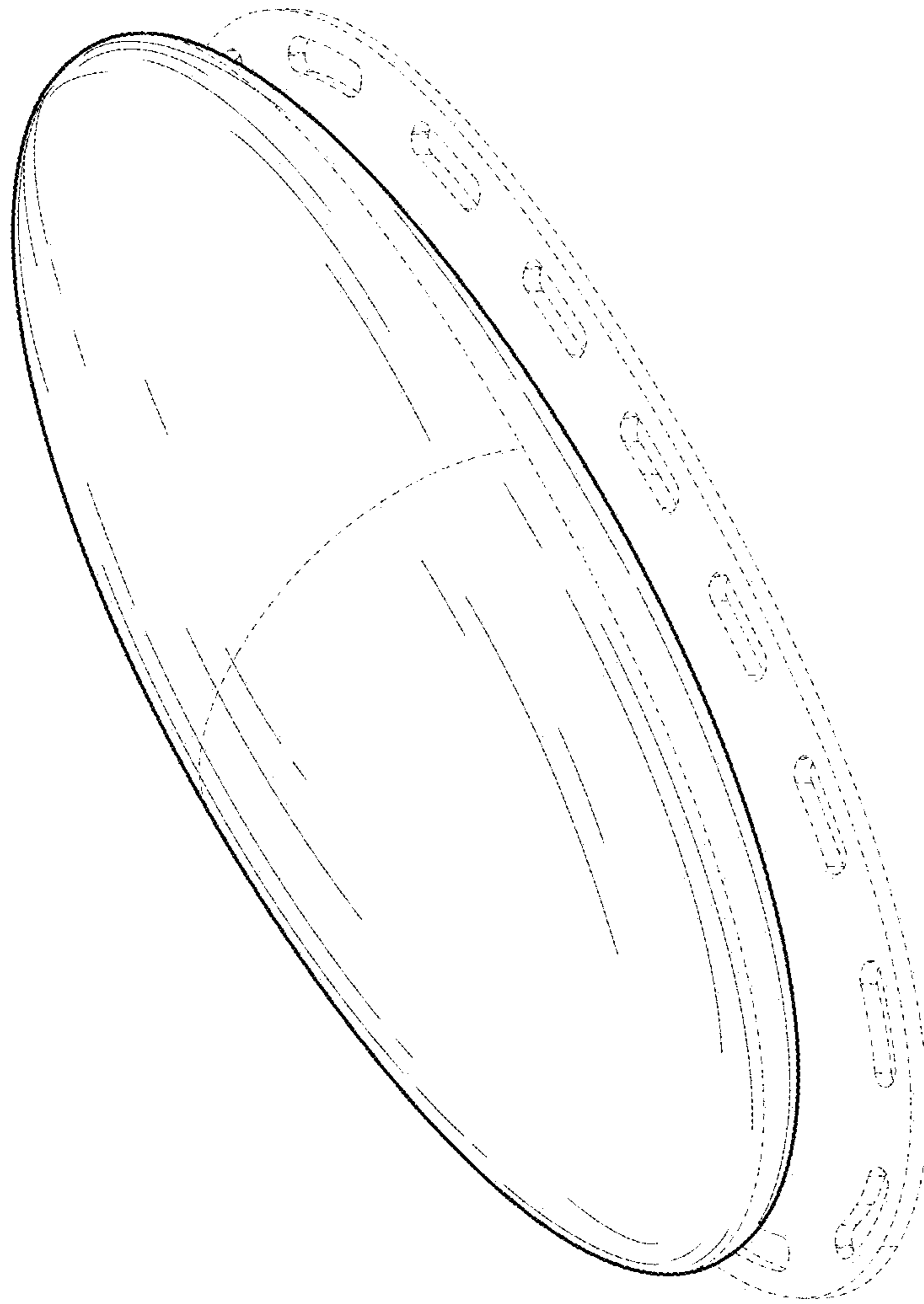

FIG. 9

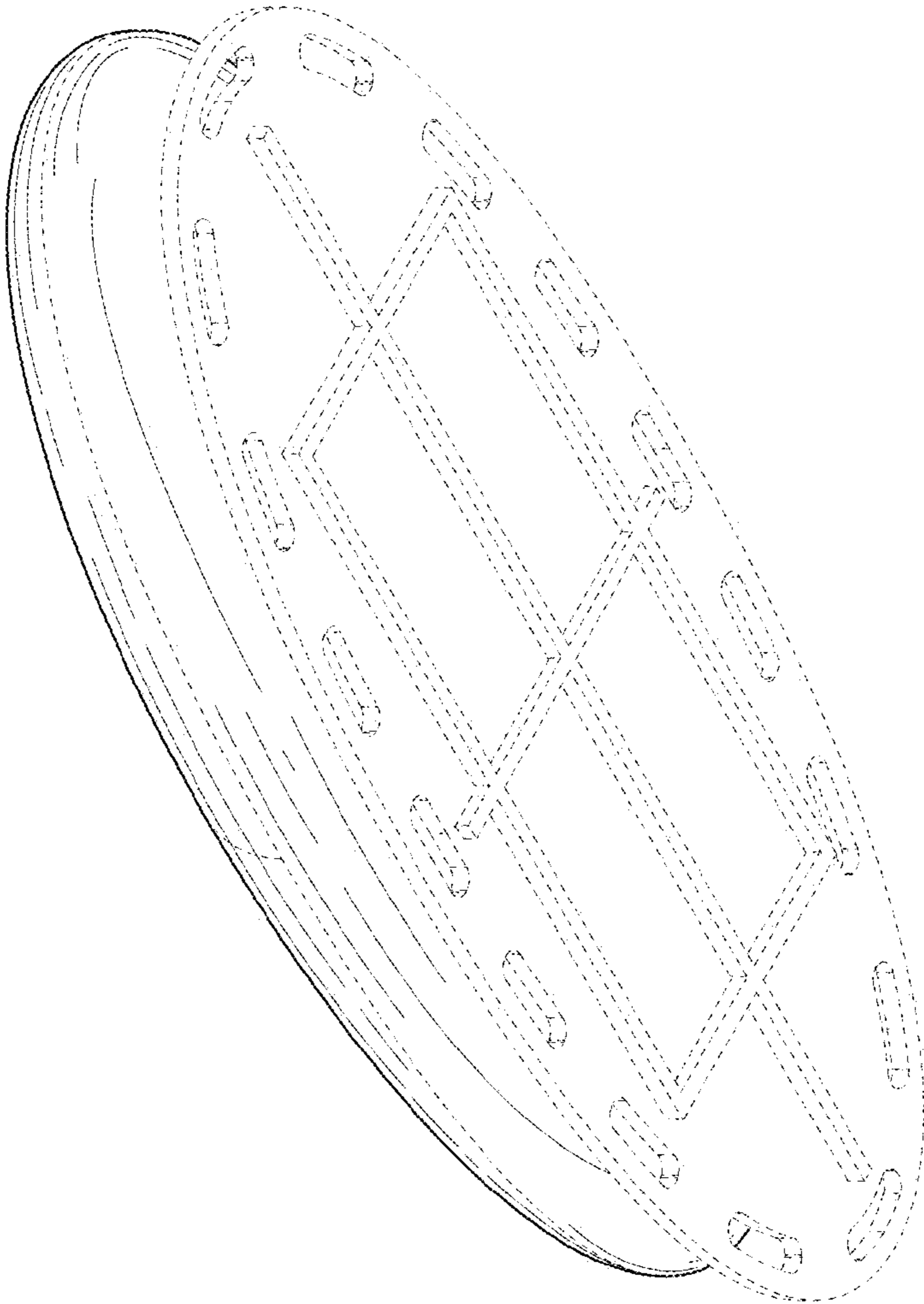

FIG. 10

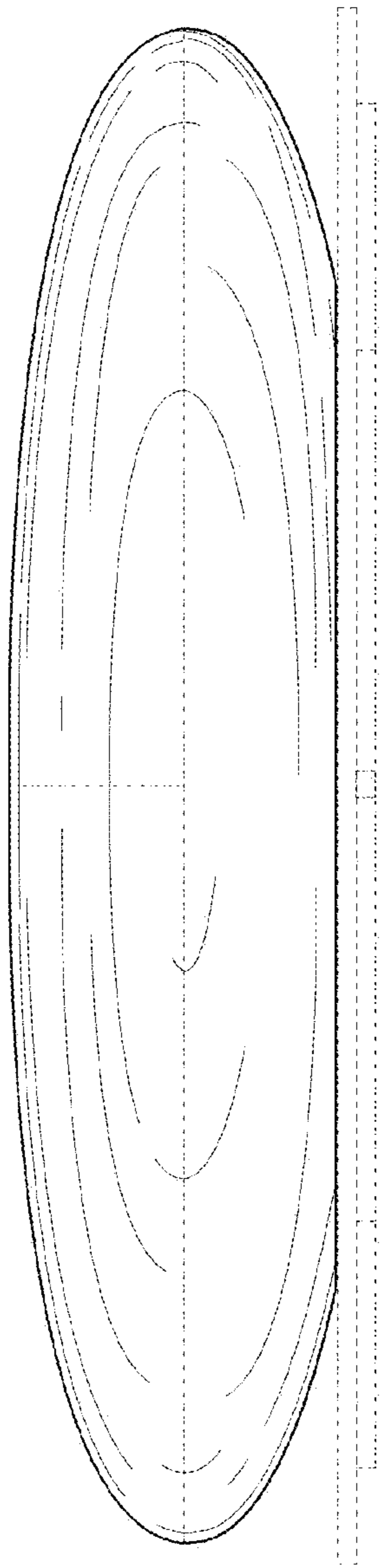

FIG. 11

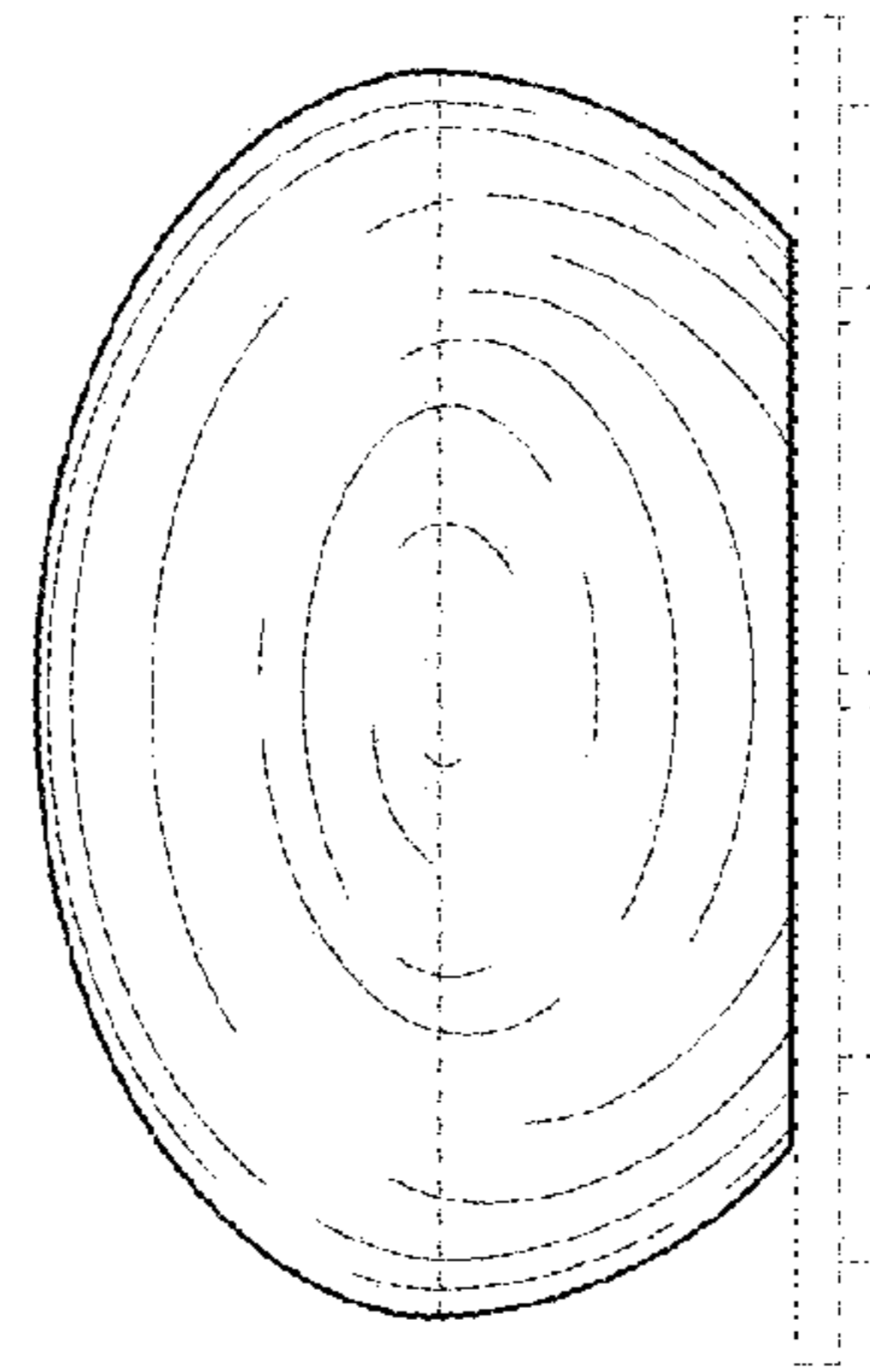

FIG. 12

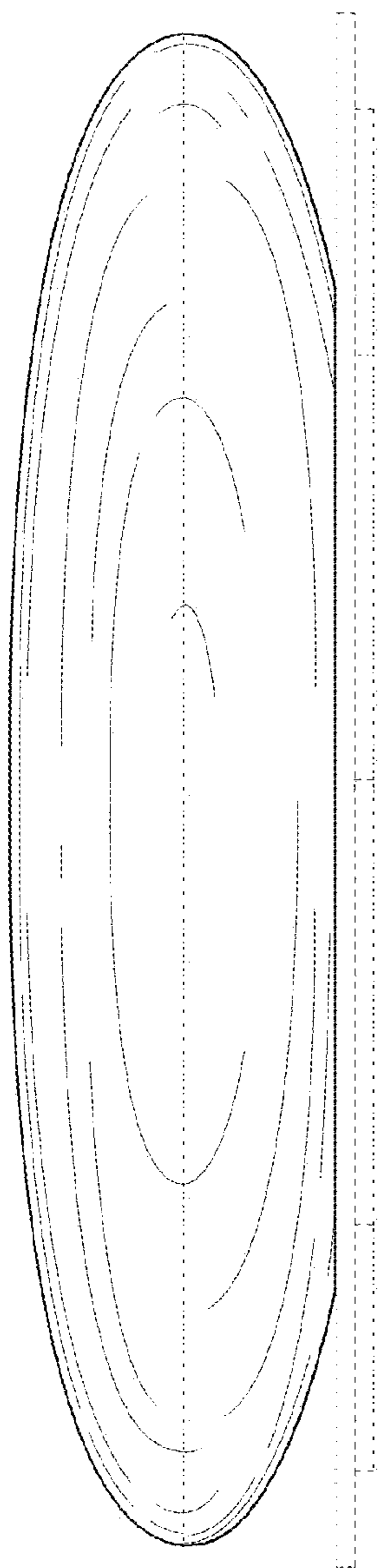

FIG. 13

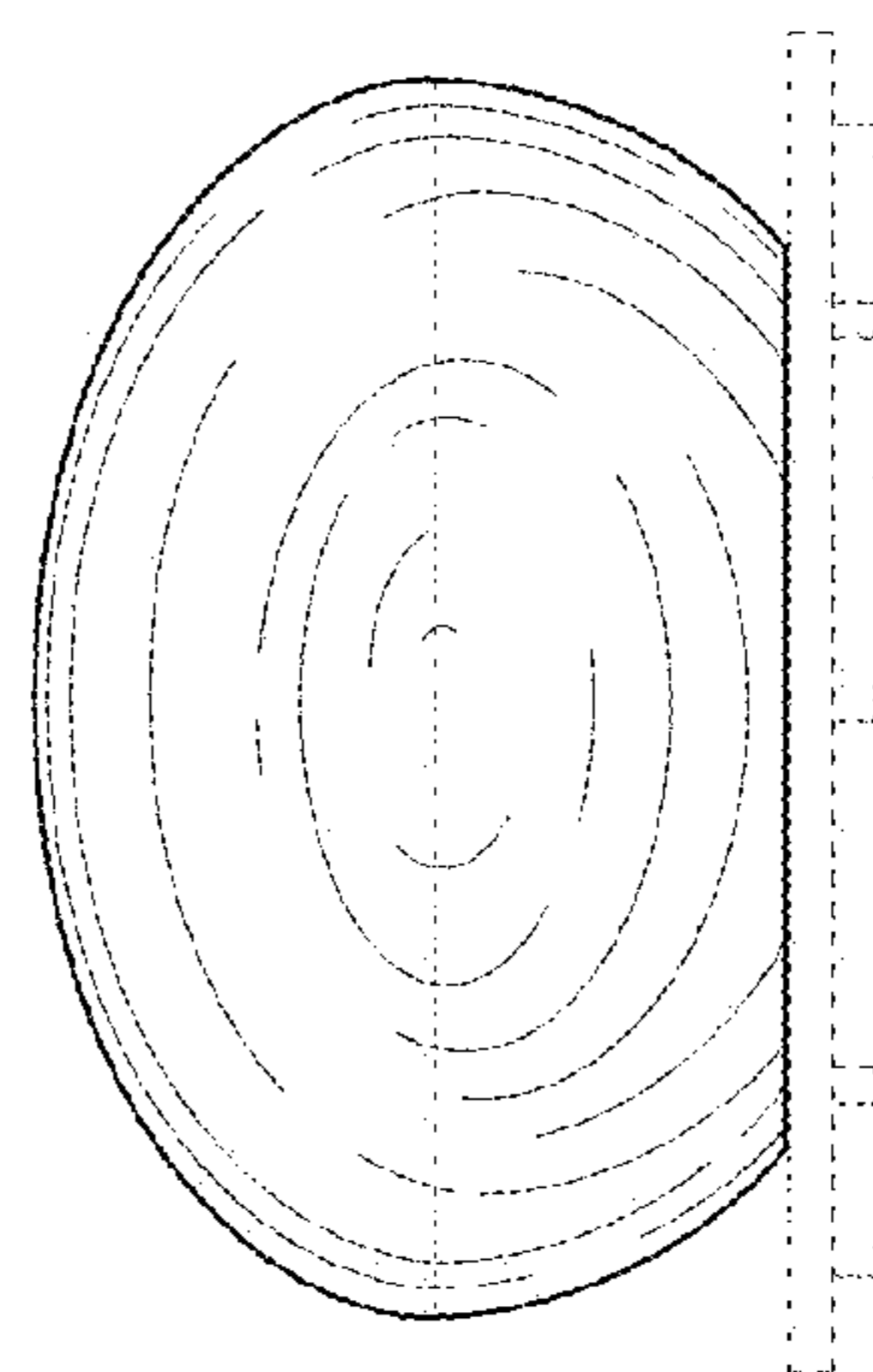

FIG. 14

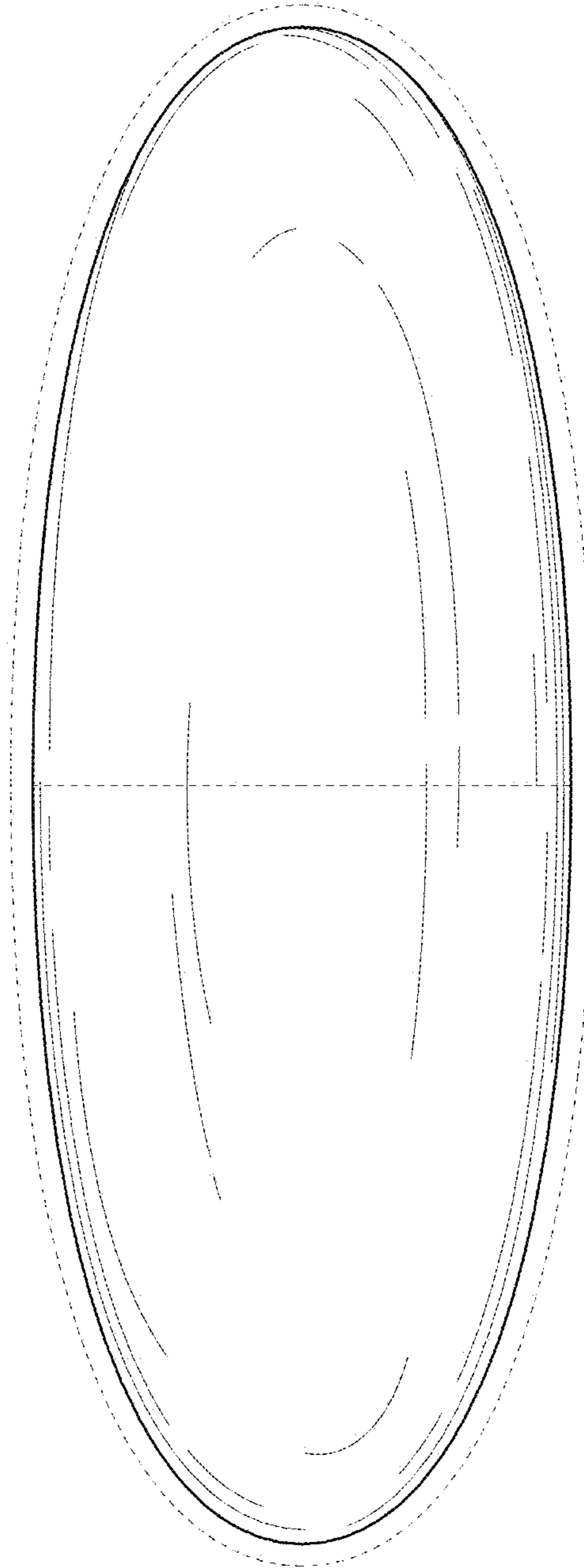

FIG. 15

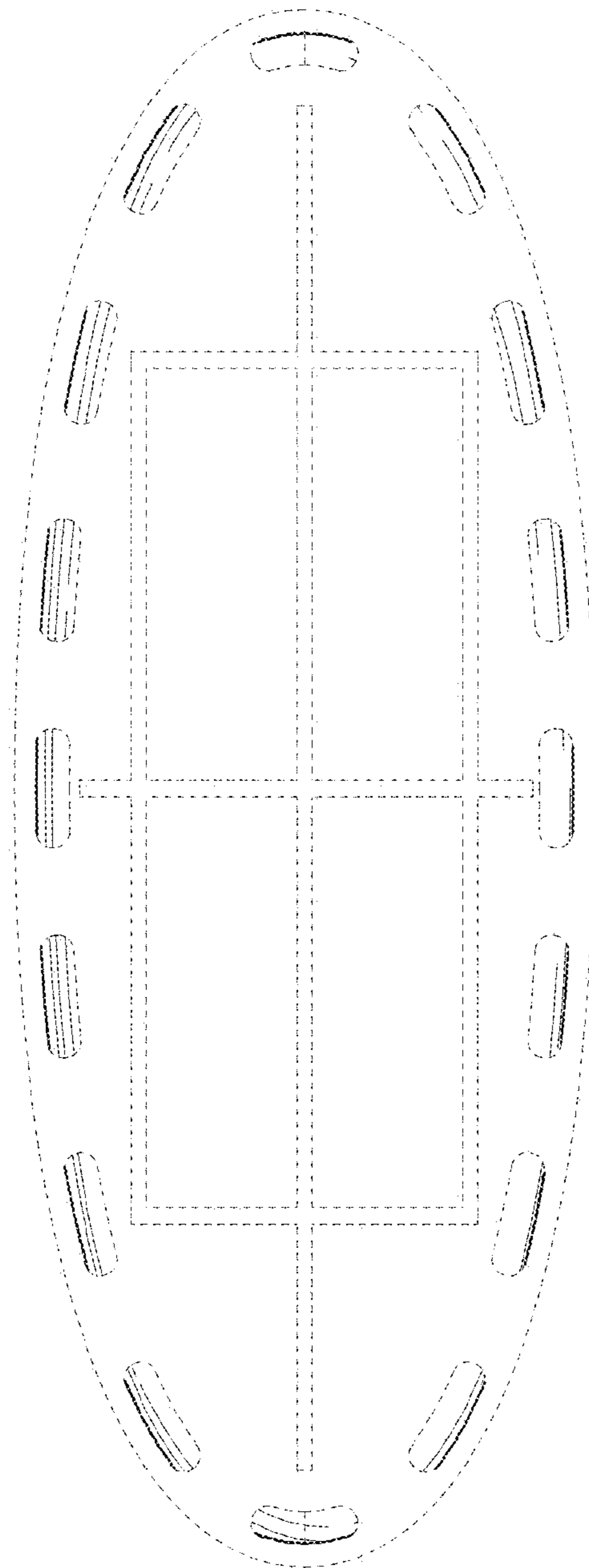

FIG. 16