

US00D727553S

(12) **United States Design Patent**
Tien et al.

(10) **Patent No.:** **US D727,553 S**
(45) **Date of Patent:** **** Apr. 21, 2015**

(54) **CEILING-MOUNTED LAMP**

(71) Applicant: **Delta Electronics, Inc.**, Taoyuan Hsien (TW)

(72) Inventors: **Kun-Ming Tien**, Taoyuan Hsien (TW);
Chih-Yuan Huang, Taoyuan Hsien (TW)

(73) Assignee: **Delta Electronics, Inc.**, Taoyuan Hsien (TW)

(**) Term: **14 Years**

(21) Appl. No.: **29/472,394**

(22) Filed: **Nov. 12, 2013**

(51) **LOC (10) Cl.** **26-03**

(52) **U.S. Cl.**
USPC **D26/89**

(58) **Field of Classification Search**
USPC D26/28, 72, 85, 89; 362/147, 287, 373,
362/453-456

See application file for complete search history.

(56) **References Cited**

U.S. PATENT DOCUMENTS

D211,820 S *	7/1968	Pettengill	D26/85
D221,181 S *	7/1971	Bobrick	D26/85
4,319,312 A *	3/1982	deVos et al.	362/282
4,507,719 A *	3/1985	Quiogue	362/404

4,827,386 A *	5/1989	Mackiewicz	362/267
D399,328 S *	10/1998	Compton	D26/72
D407,838 S *	4/1999	Compton	D26/67
D426,010 S *	5/2000	Compton	D26/67
6,394,628 B1 *	5/2002	Wang	362/375
D702,393 S *	4/2014	Ansierowicz et al.	D26/89
D703,861 S *	4/2014	Holland et al.	D26/89
D707,383 S *	6/2014	Carraher	D26/89

* cited by examiner

Primary Examiner — Clare E Heflin

(74) *Attorney, Agent, or Firm* — Muncy, Geissler, Olds & Lowe, P.C.

(57) **CLAIM**

The ornamental design for a ceiling-mounted lamp, as shown and described.

DESCRIPTION

FIG. 1 is a front perspective view of a ceiling-mounted lamp showing my new design;

FIG. 2 is a front elevational view thereof;

FIG. 3 is a rear elevational view thereof;

FIG. 4 is a left side elevational view thereof;

FIG. 5 is a right side elevational view thereof;

FIG. 6 is a top plan view thereof; and,

FIG. 7 is a bottom plan view thereof.

The broken lines shown on the drawings depict portions of the ceiling-mounted lamp that form no part of the claimed design.

1 Claim, 7 Drawing Sheets

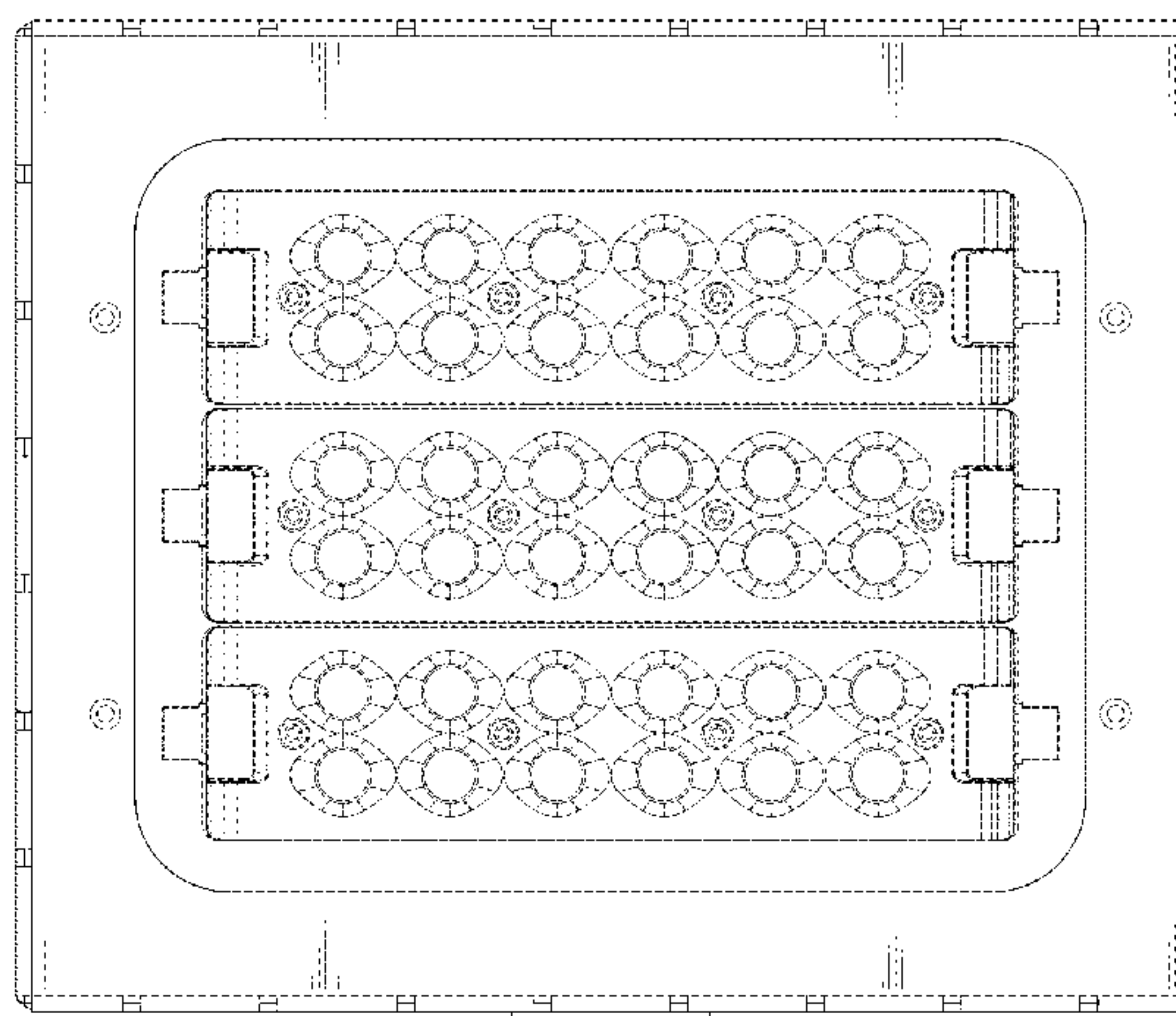
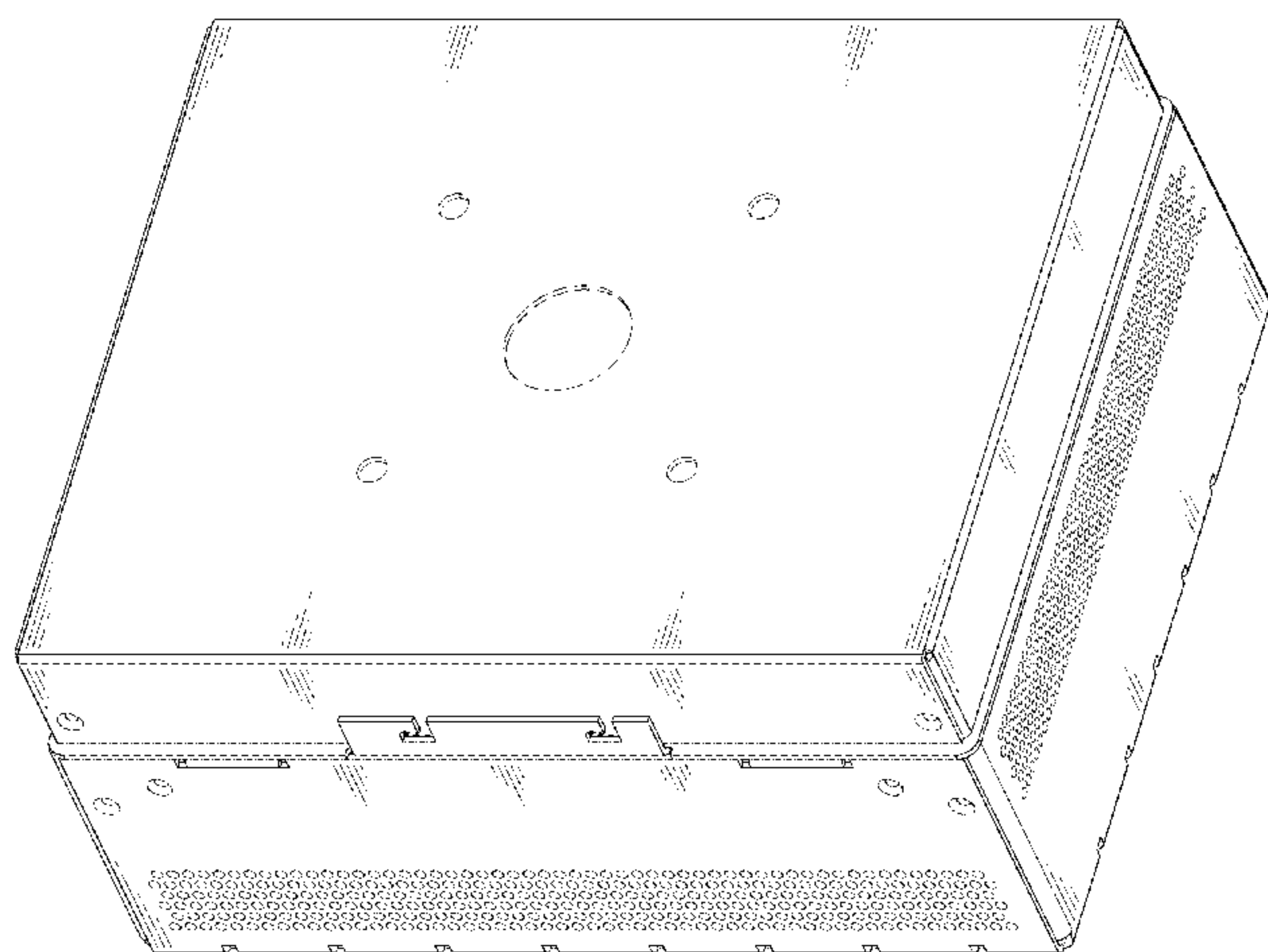

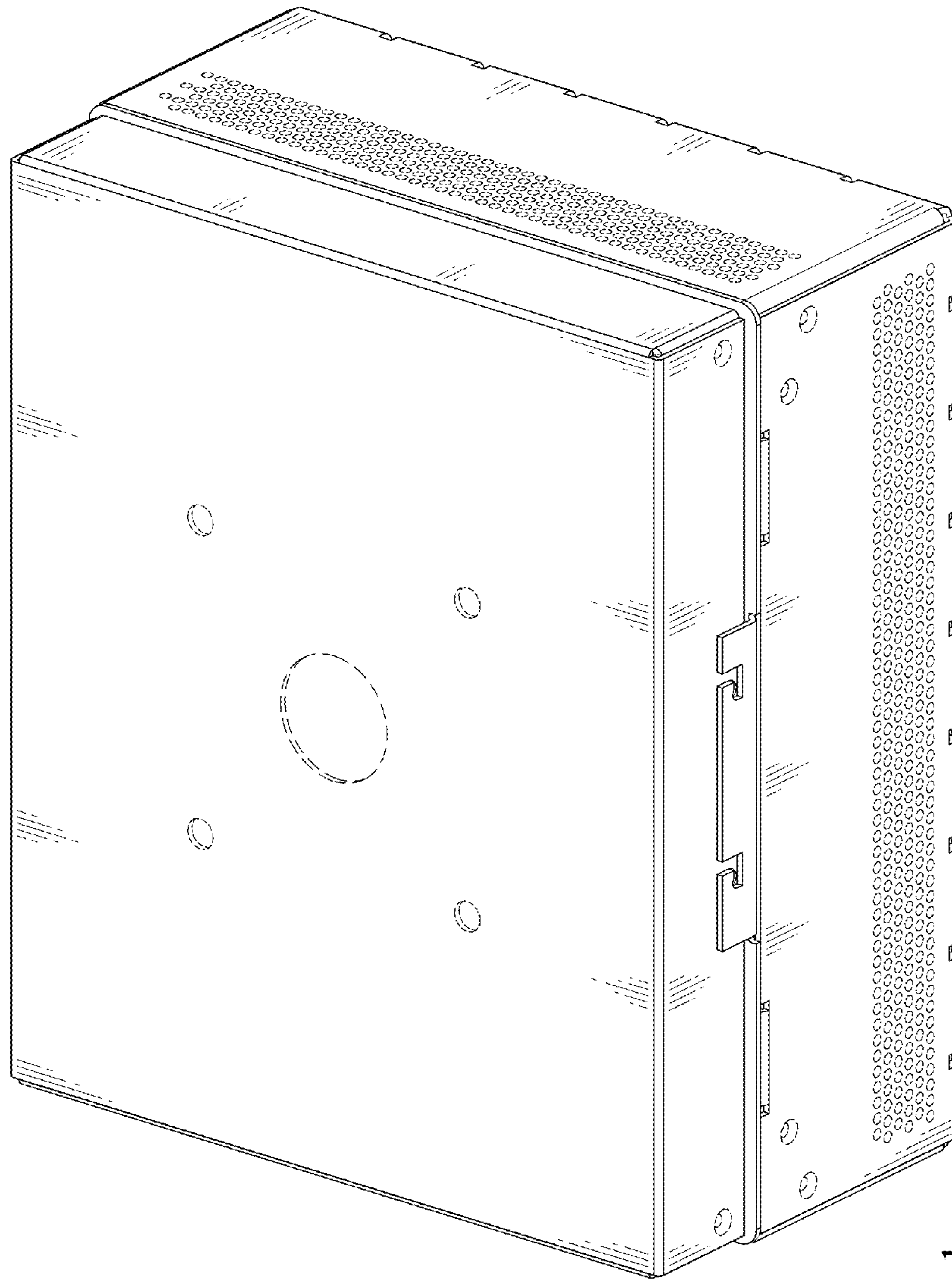

FIG. 1

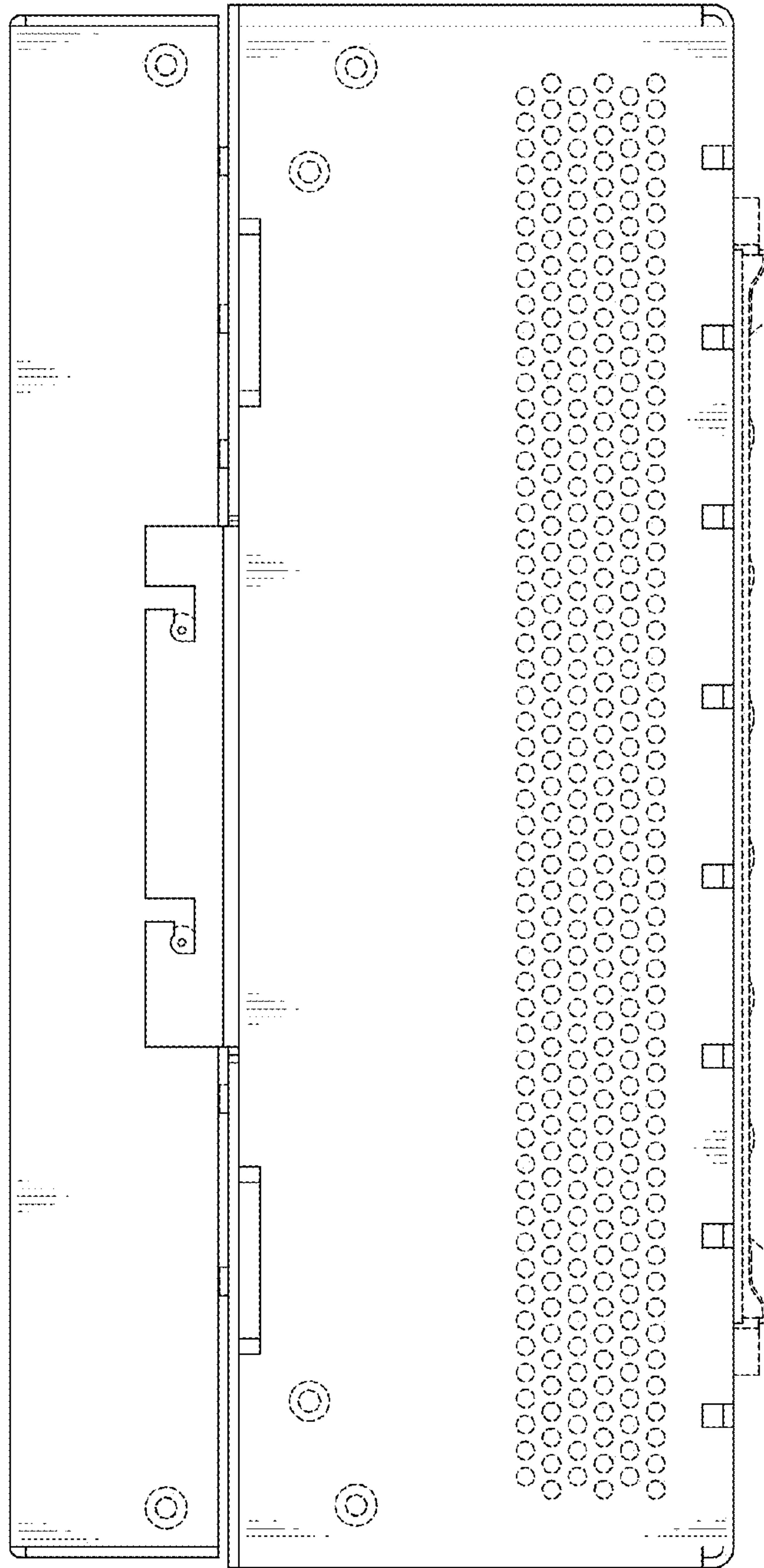

FIG. 2

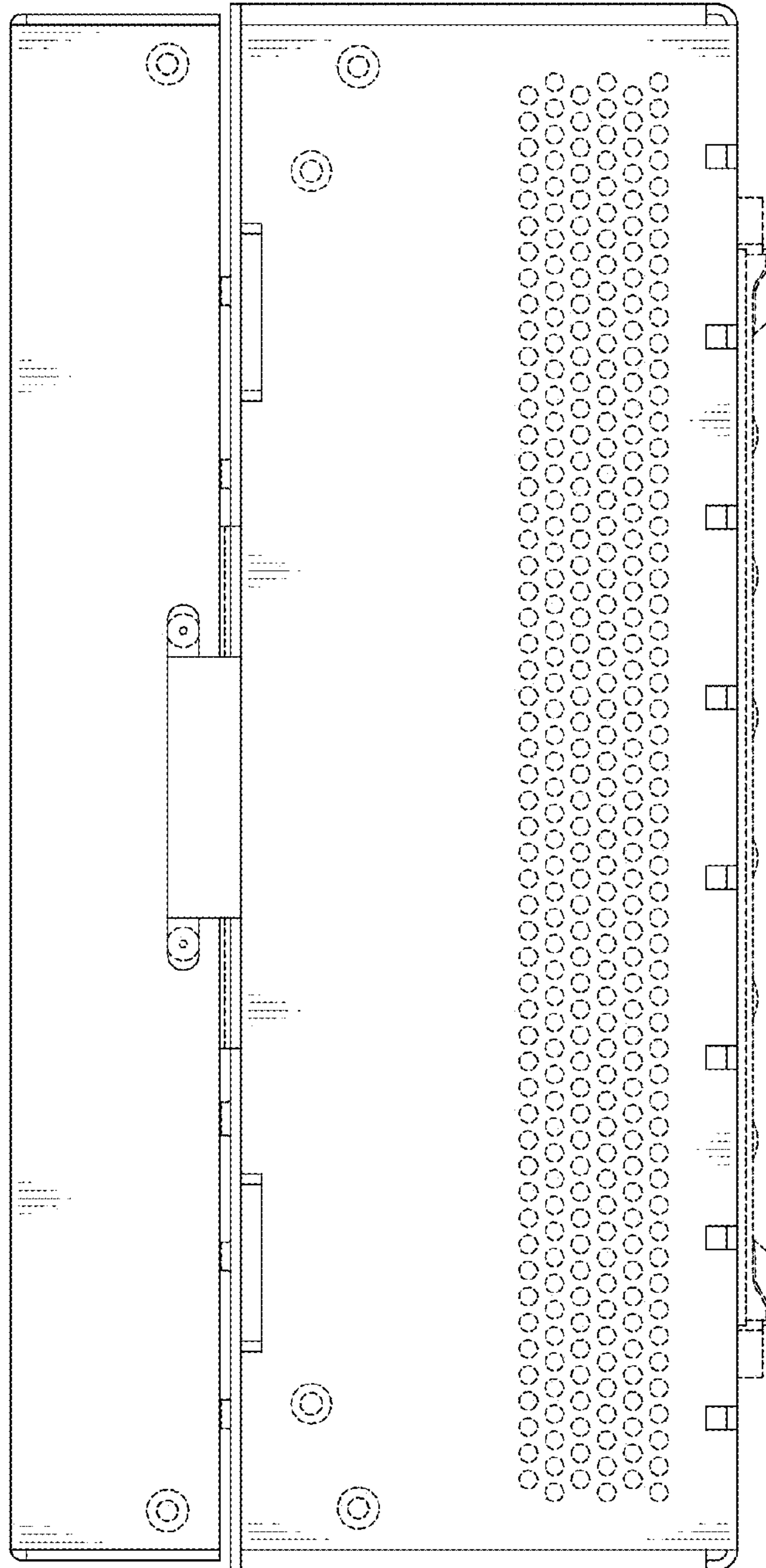

FIG. 3

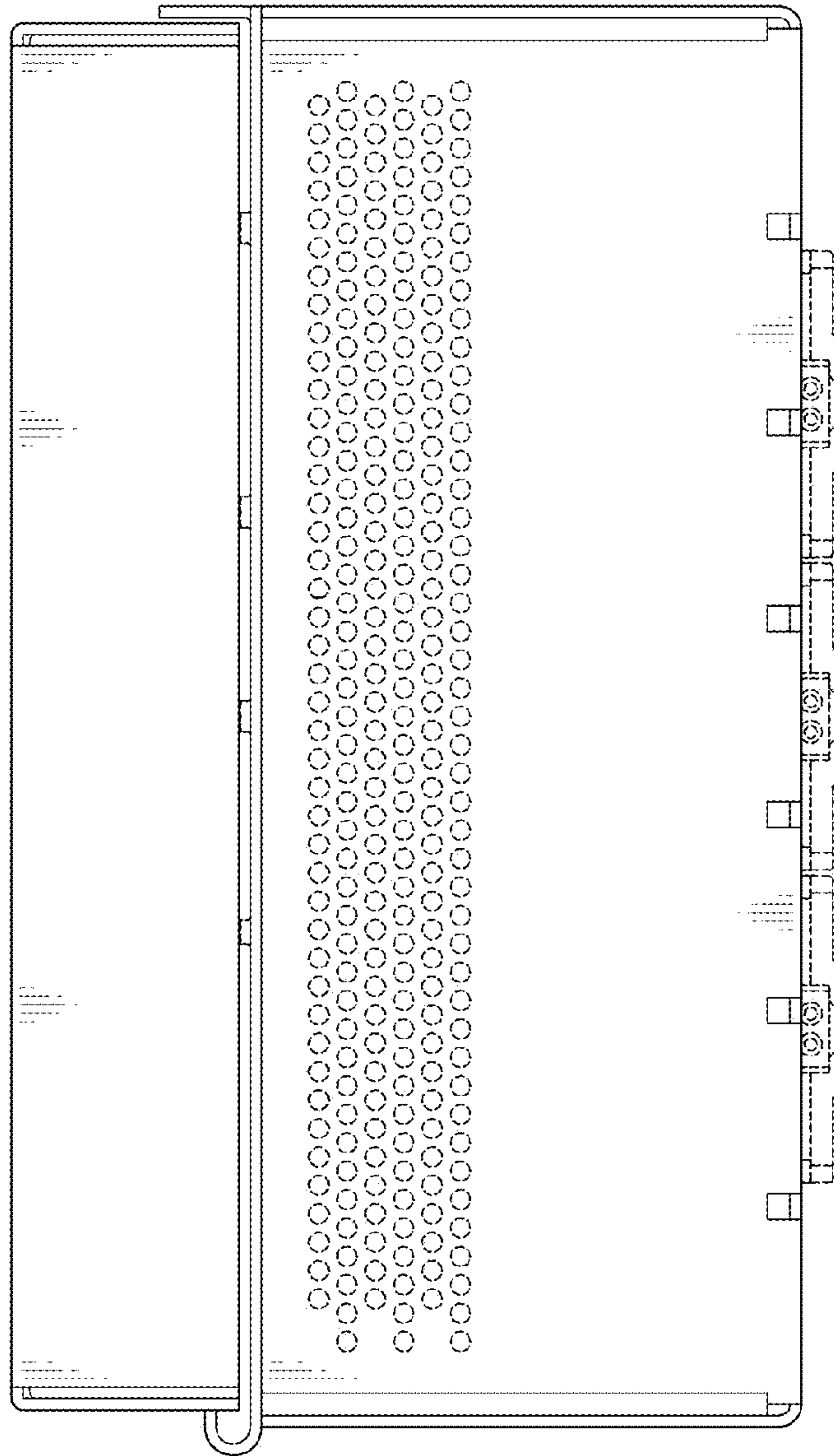

FIG. 4

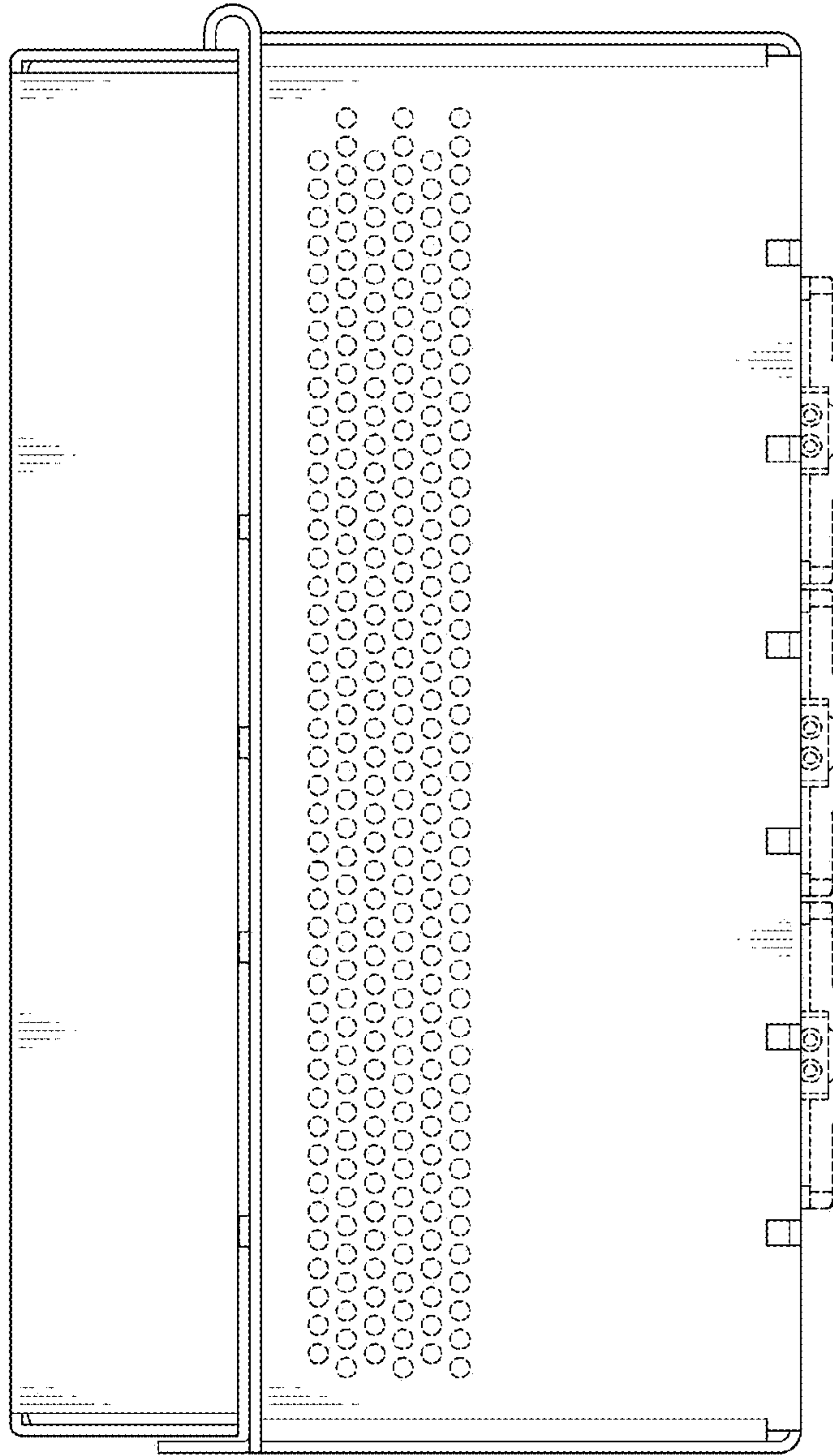

FIG. 5

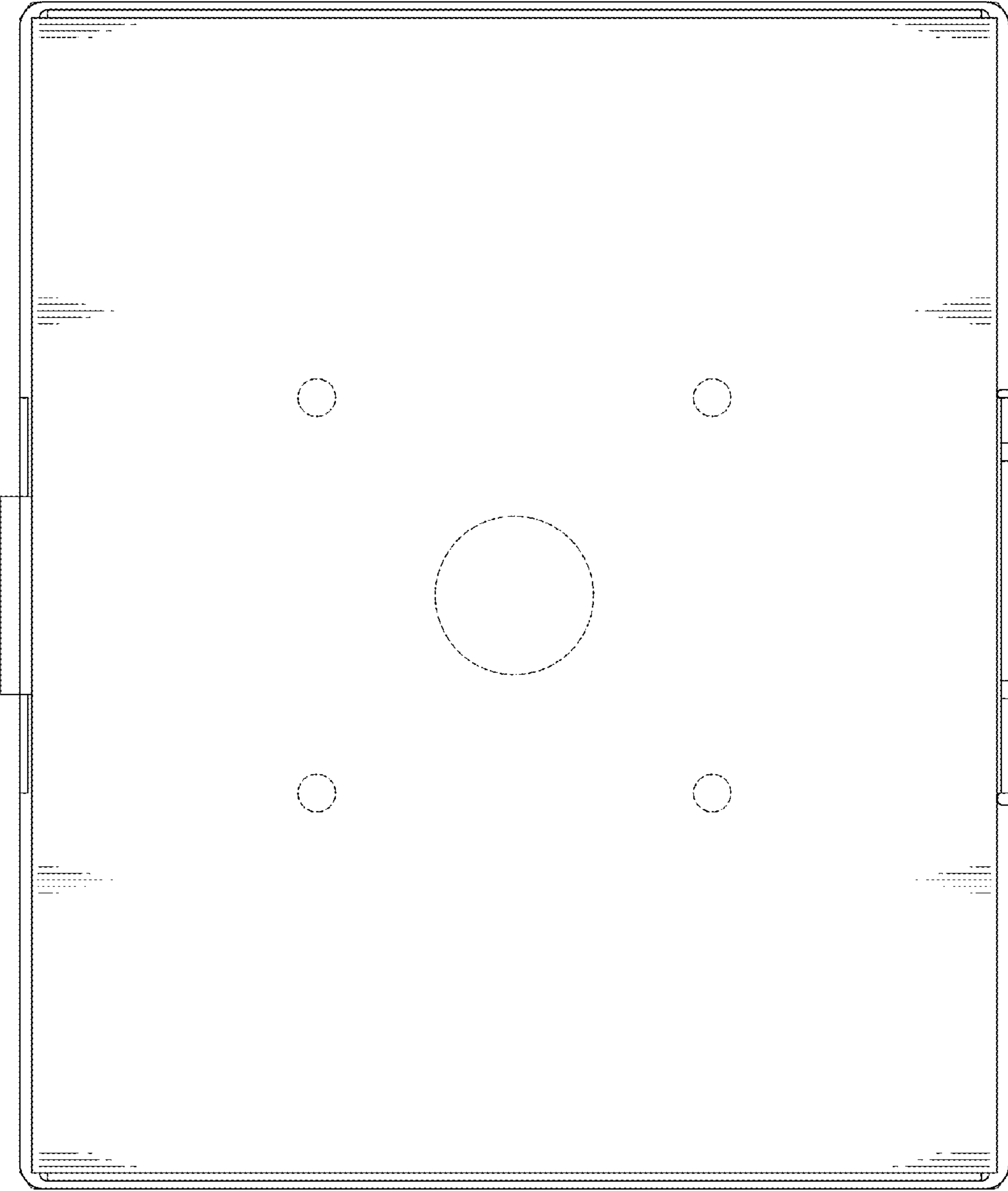

FIG. 6

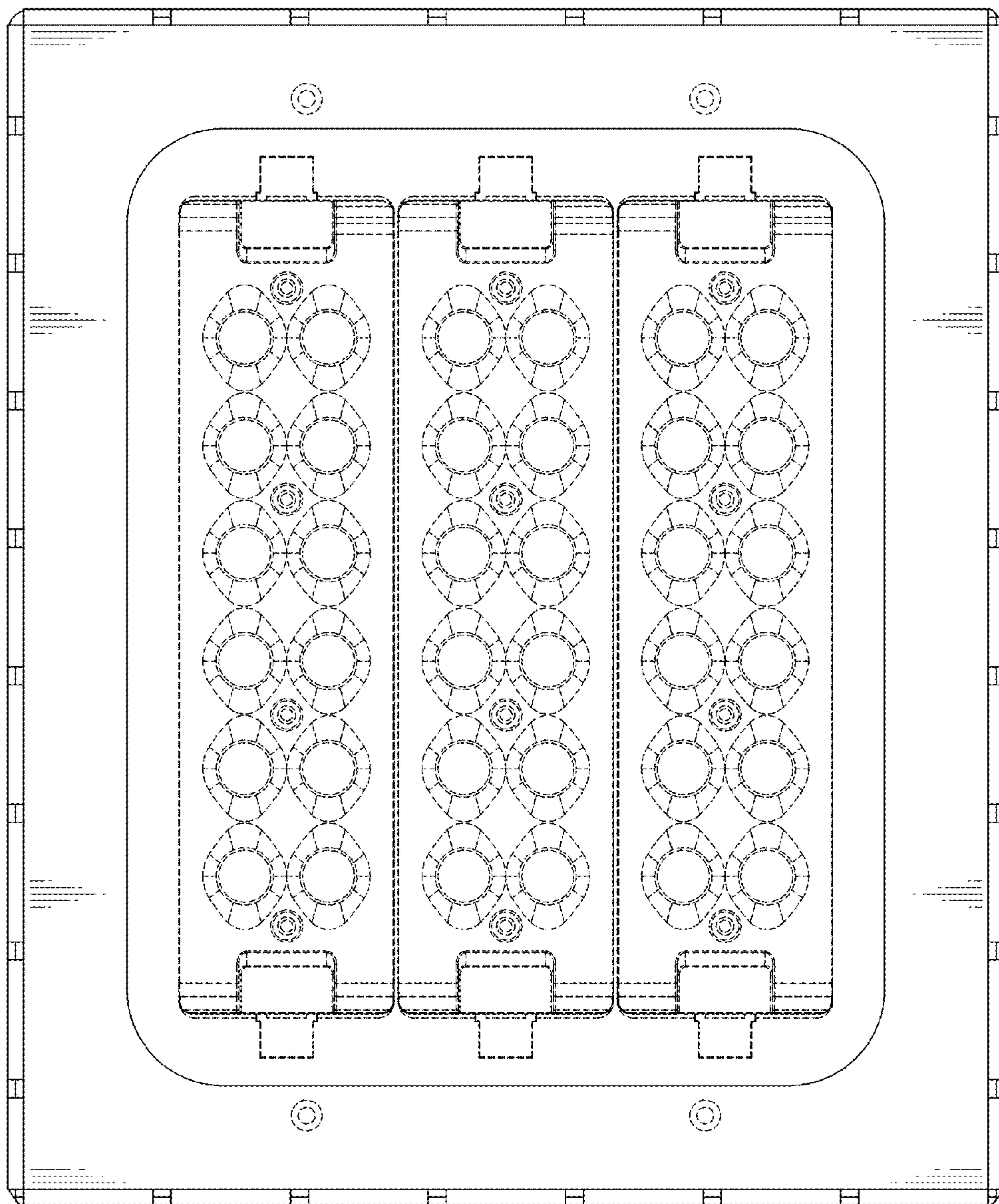

FIG. 7