



US00D727467S

(12) **United States Design Patent**
Batiste

(10) **Patent No.:** **US D727,467 S**

(45) **Date of Patent:** **** Apr. 21, 2015**

(54) **VALVE COVER**

(71) Applicant: **Puronics Inc.**, Livermore, CA (US)

(72) Inventor: **Scott A. Batiste**, Livermore, CA (US)

(73) Assignee: **Puronics Inc.**, Livermore, CA (US)

(**) Term: **14 Years**

(21) Appl. No.: **29/485,219**

(22) Filed: **Mar. 17, 2014**

(51) **LOC (10) Cl.** **23-01**

(52) **U.S. Cl.**
USPC **D23/249**

(58) **Field of Classification Search**

CPC F16K 27/12; F16K 35/10; F16K 27/048;
F16K 1/2007; F16K 27/0209; F16K 27/041;
F16K 31/0613; F16K 51/02; F16K 15/026;
F16K 31/0637; F16K 35/027; F16K 35/04;
B67D 1/0418; F04B 53/10
USPC D23/209, 233-250; D10/85, 102, 103,
D10/84, 99, 52, 46, 49; 73/738, 737, 741,
73/708, 866.5, 431, 715, 706; 116/297

See application file for complete search history.

(56) **References Cited**

U.S. PATENT DOCUMENTS

D99,332 S * 4/1936 Rice D23/235
2,216,374 A * 10/1940 Martin 73/706
D153,064 S * 3/1949 Hammon D23/235
D153,244 S * 3/1949 Teague D23/235
D156,391 S * 12/1949 Wertheimer D10/49
2,607,228 A * 8/1952 Coxon 73/715
D179,181 S * 11/1956 Becker D23/209
3,335,610 A * 8/1967 Nelson 73/738
3,520,192 A * 7/1970 Condie 73/738
3,929,020 A * 12/1975 Honkanen 73/738
4,051,730 A * 10/1977 Andrews et al. 73/738

4,124,931 A * 11/1978 Miele, Jr. 29/407.05
4,175,444 A * 11/1979 Harland 73/738
4,196,633 A * 4/1980 Bissell 73/738
D255,225 S * 6/1980 Lewis D10/102
D259,734 S * 6/1981 Cerrato D23/235
D288,469 S * 2/1987 Pryor D23/235
D291,231 S * 8/1987 Datta D23/235
4,838,090 A * 6/1989 Hestich 73/738
D302,394 S * 7/1989 Merrell D10/85
D317,269 S * 6/1991 Selg D10/52
D351,113 S * 10/1994 Hermansen D10/85
D353,113 S * 12/1994 Cook-Martin D10/85
D416,822 S * 11/1999 Slate et al. D10/103

(Continued)

OTHER PUBLICATIONS

Puronics Hydronex The Next Generation of Ionics Solutions, 2008.
Accessed Nov. 3, 2014.

(Continued)

Primary Examiner — Cynthia Ramirez

Assistant Examiner — Gino Colan

(74) *Attorney, Agent, or Firm* — Wilson Sonsini Goodrich &
Rosati

(57) **CLAIM**

The ornamental design for a valve cover, as shown and
described.

DESCRIPTION

FIG. 1 is a front perspective view of a valve cover;

FIG. 2 is a top view of the valve cover;

FIG. 3 is a front view of the valve cover;

FIG. 4 is a left side view of the valve cover;

FIG. 5 is a right side view of the valve cover; and,

FIG. 6 is a rear view of the valve cover.

The broken lines in the figures are for illustrative purposes
only and form no part of the claimed design.

1 Claim, 3 Drawing Sheets

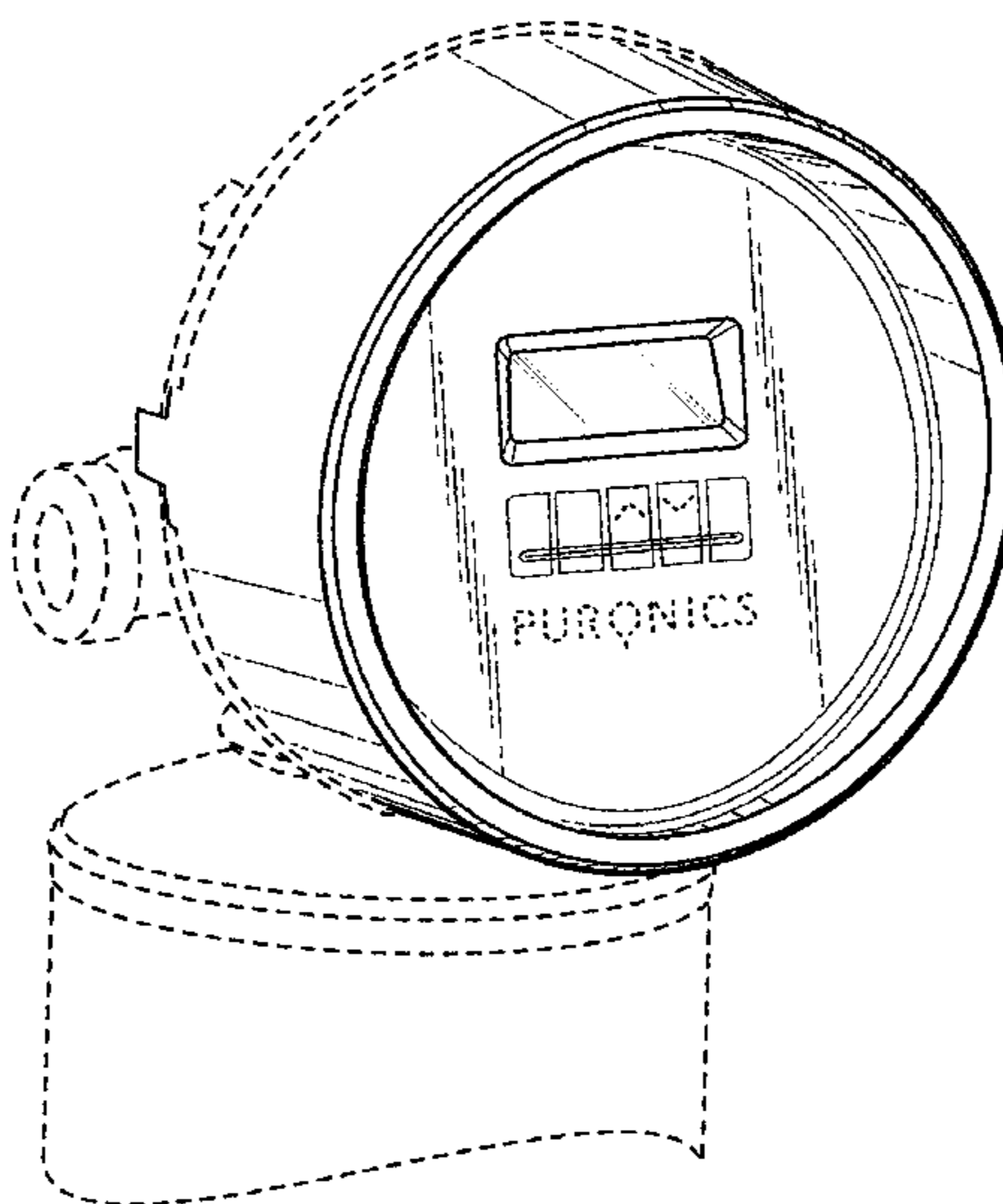

(56)

References Cited

U.S. PATENT DOCUMENTS

6,672,178	B2 *	1/2004	Durnen	73/866.5
D486,748	S *	2/2004	Cain	D10/102
D512,334	S *	12/2005	Tang	D10/85
D514,007	S *	1/2006	Buchanan	D10/99
7,036,382	B2 *	5/2006	Sherman et al.	73/715
7,047,811	B2 *	5/2006	Sherman et al.	73/708
D543,476	S *	5/2007	Barmettler et al.	D10/85
D545,707	S *	7/2007	Barmettler et al.	D10/85
7,278,317	B2 *	10/2007	Besette et al.	73/708
D607,356	S *	1/2010	Moon et al.	D10/85
D612,277	S *	3/2010	Cain et al.	D10/85
D631,944	S *	2/2011	Karmel et al.	D23/233
D678,476	S *	3/2013	Shumway	D23/235
8,495,916	B2 *	7/2013	Popp	73/700
D698,010	S *	1/2014	Boyer	D23/235
D700,075	S *	2/2014	Bould et al.	D10/49
2008/0271540	A1 *	11/2008	Wu	73/741

OTHER PUBLICATIONS

Ecowater Systems website. Accessed Nov. 3, 2014. ecowater.com.
 Kinetico Home Water Systems website. Accessed Nov. 3, 2014. www.kinetico.com.
 AdvantaPure website. Accessed Nov. 3, 2014. www.advantapure.com.
 Proelite website. Accessed Nov. 3, 2014. www.proelitesystems.com.
 Best Water Technology website. Accessed Nov. 3, 2014. <https://www.bwt.de/de/Produkte/Haustechnik/Enthaerter/Seiten/default.aspx>.
 Culligan website. Accessed Nov. 3, 2014. www.culligan.com.
 Rainsoft website. Accessed Nov. 3, 2014. www.rainsoft.com.
 Office action dated Dec. 10, 2014 for U.S. Appl. No. 29/486,278.
 Notice of allowance dated Feb. 4, 2015 for U.S. Appl. No. 29/486,278.

* cited by examiner

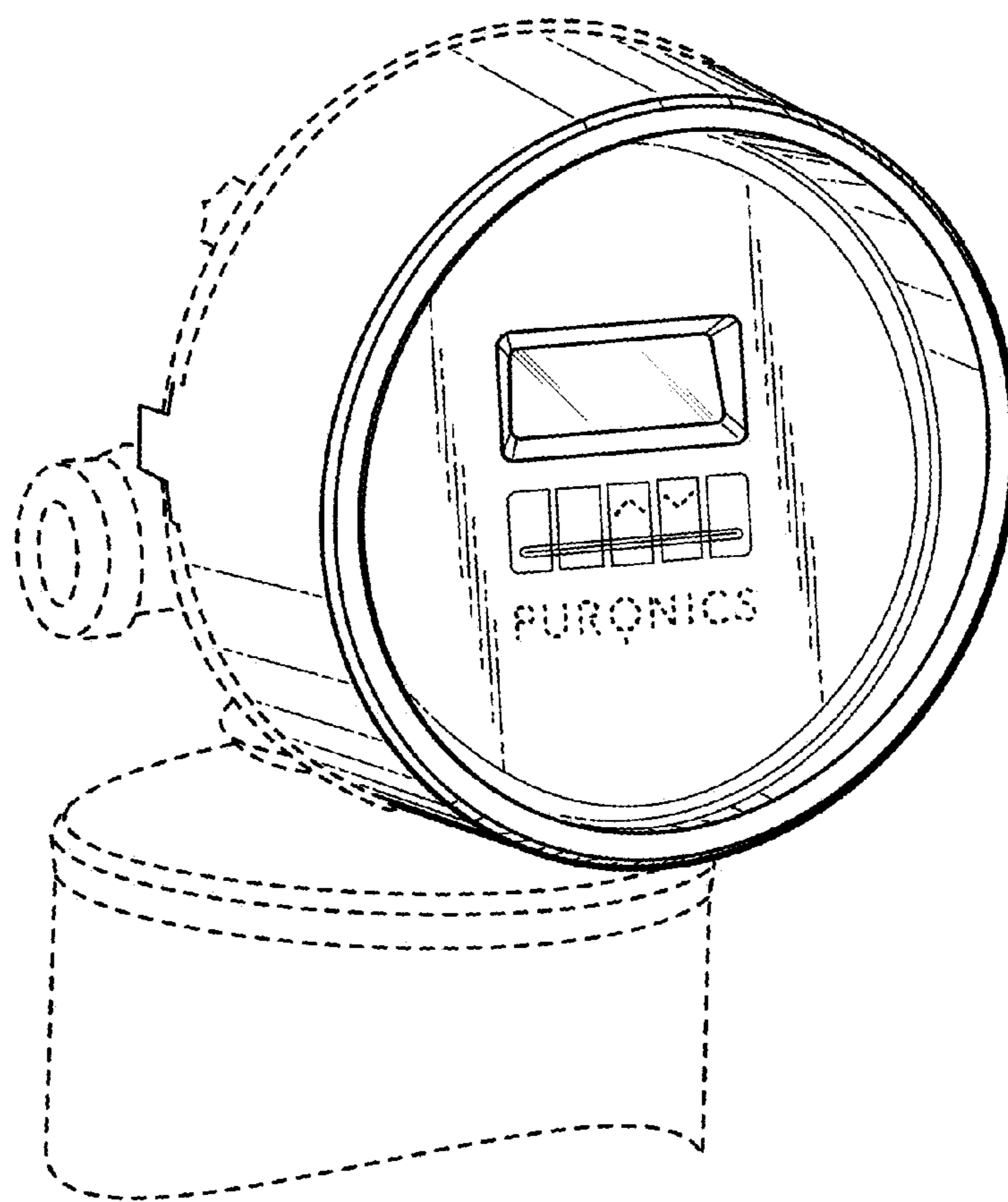

FIG. 1

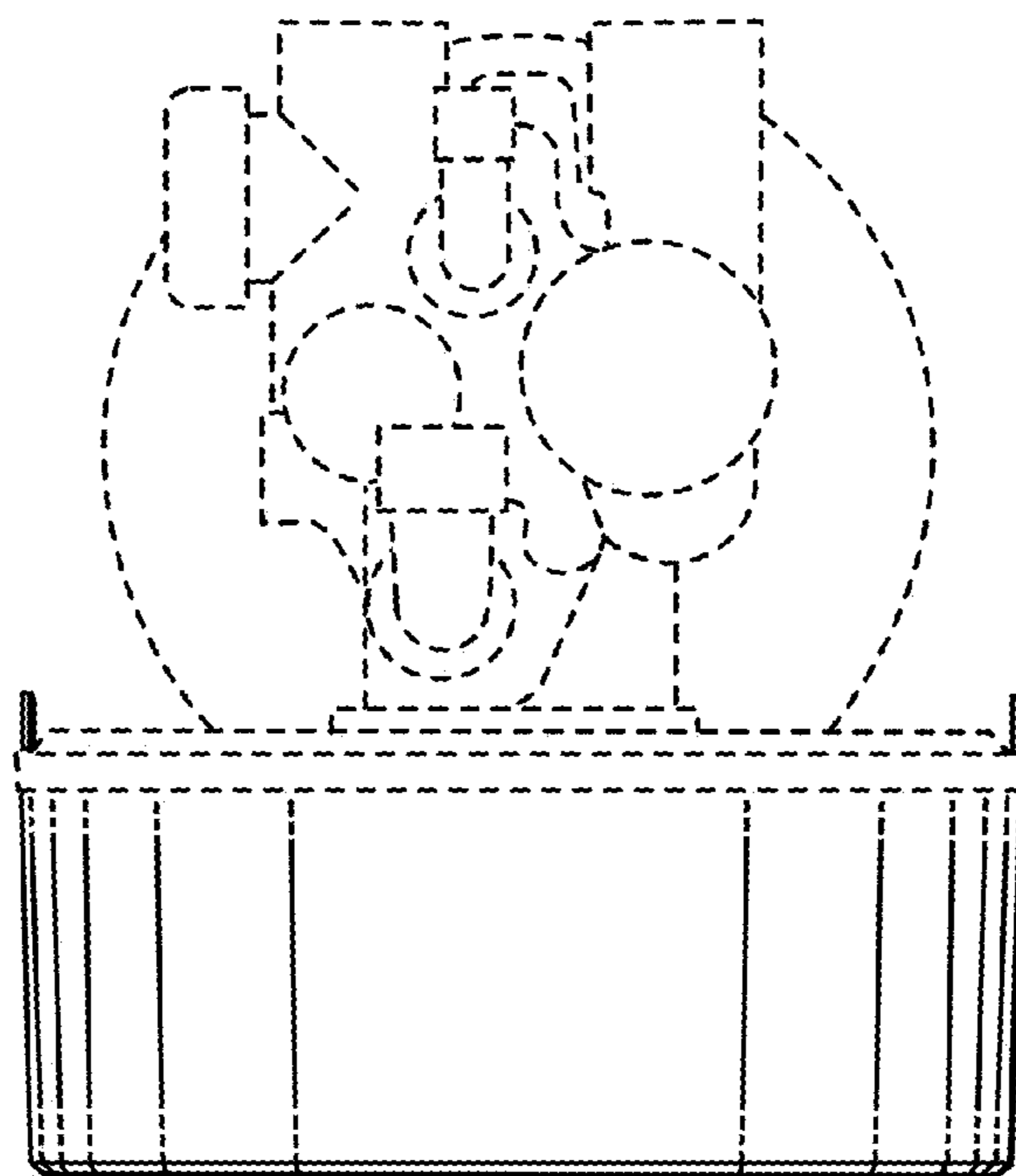

FIG. 2

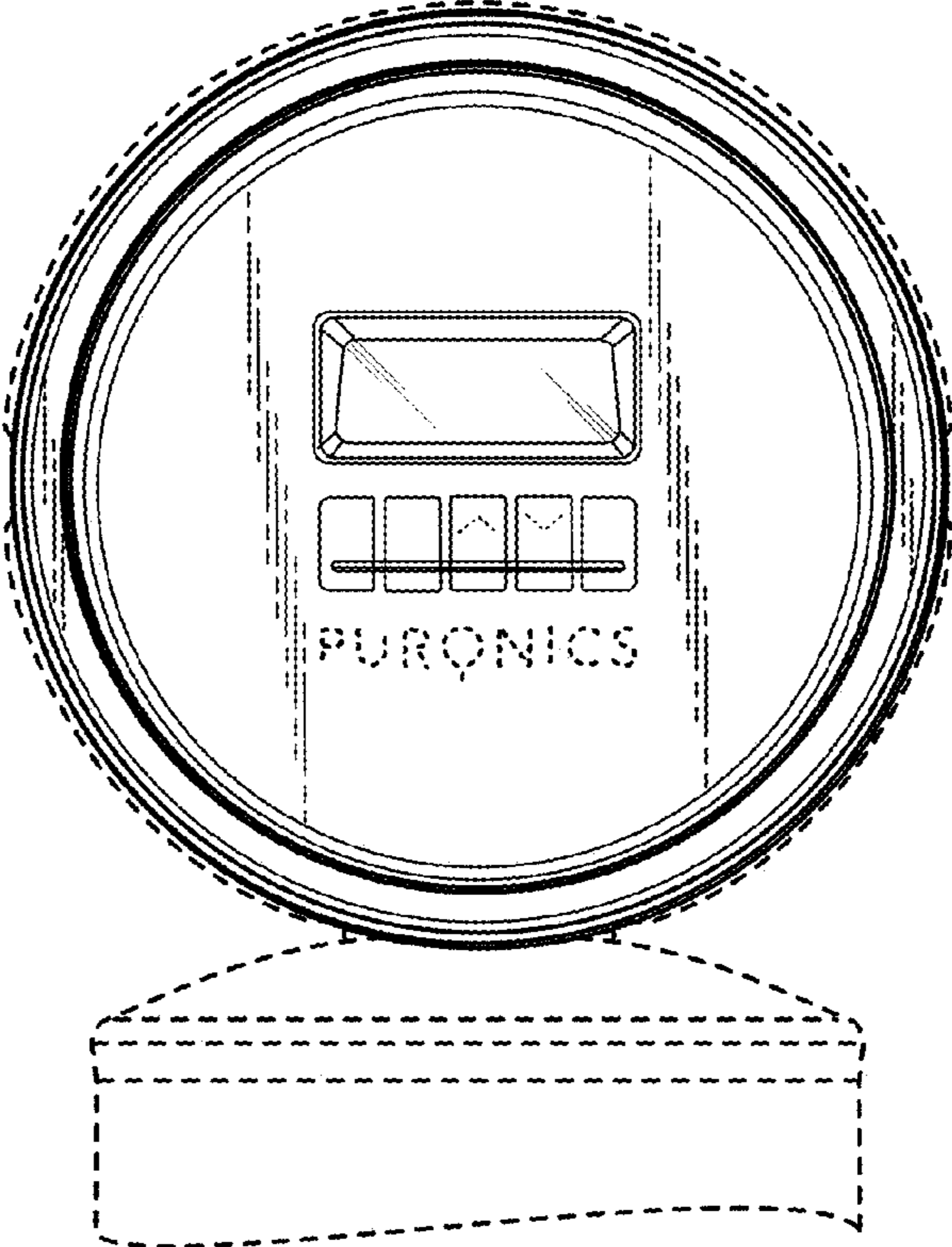

FIG. 3

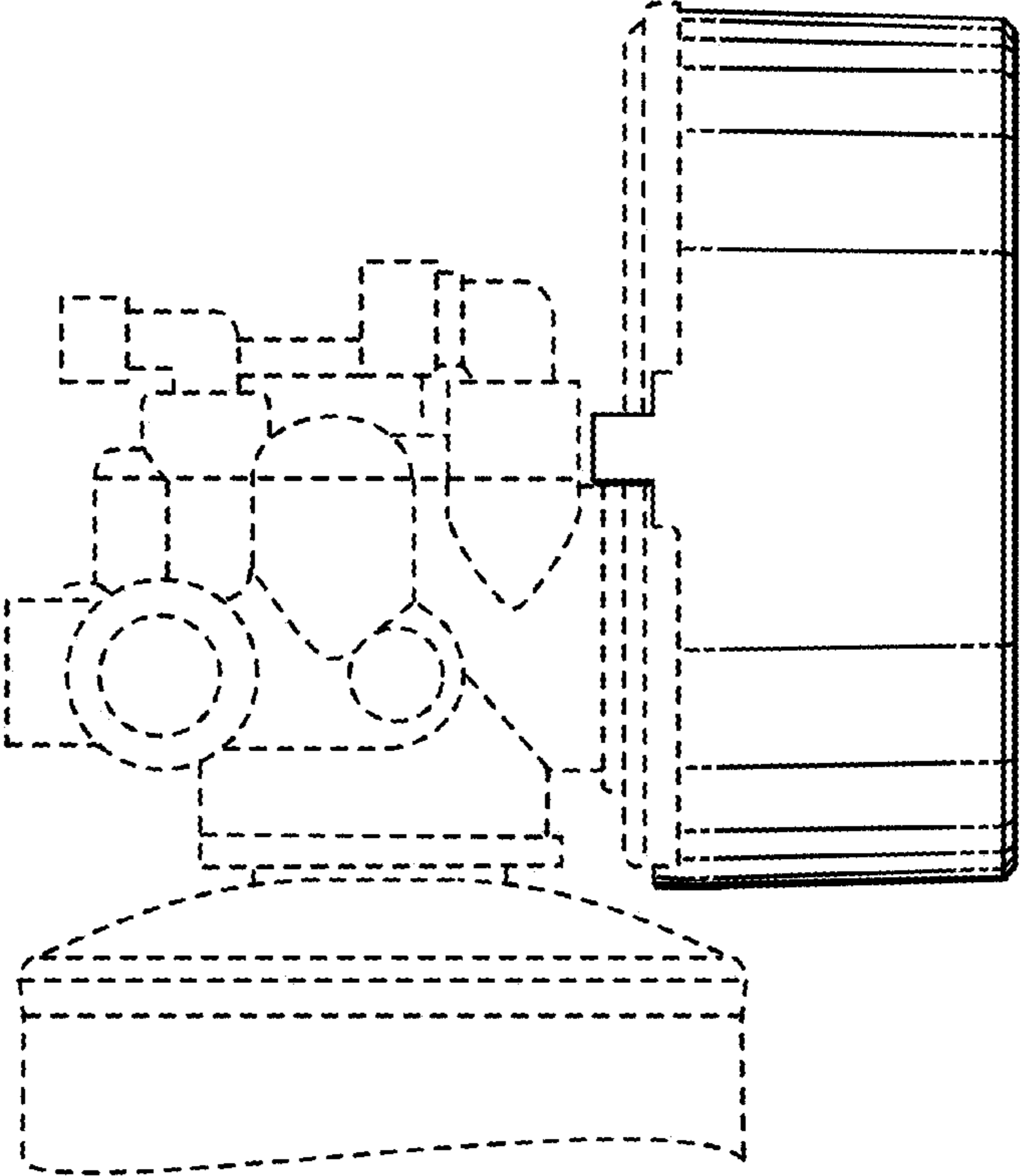

FIG. 4

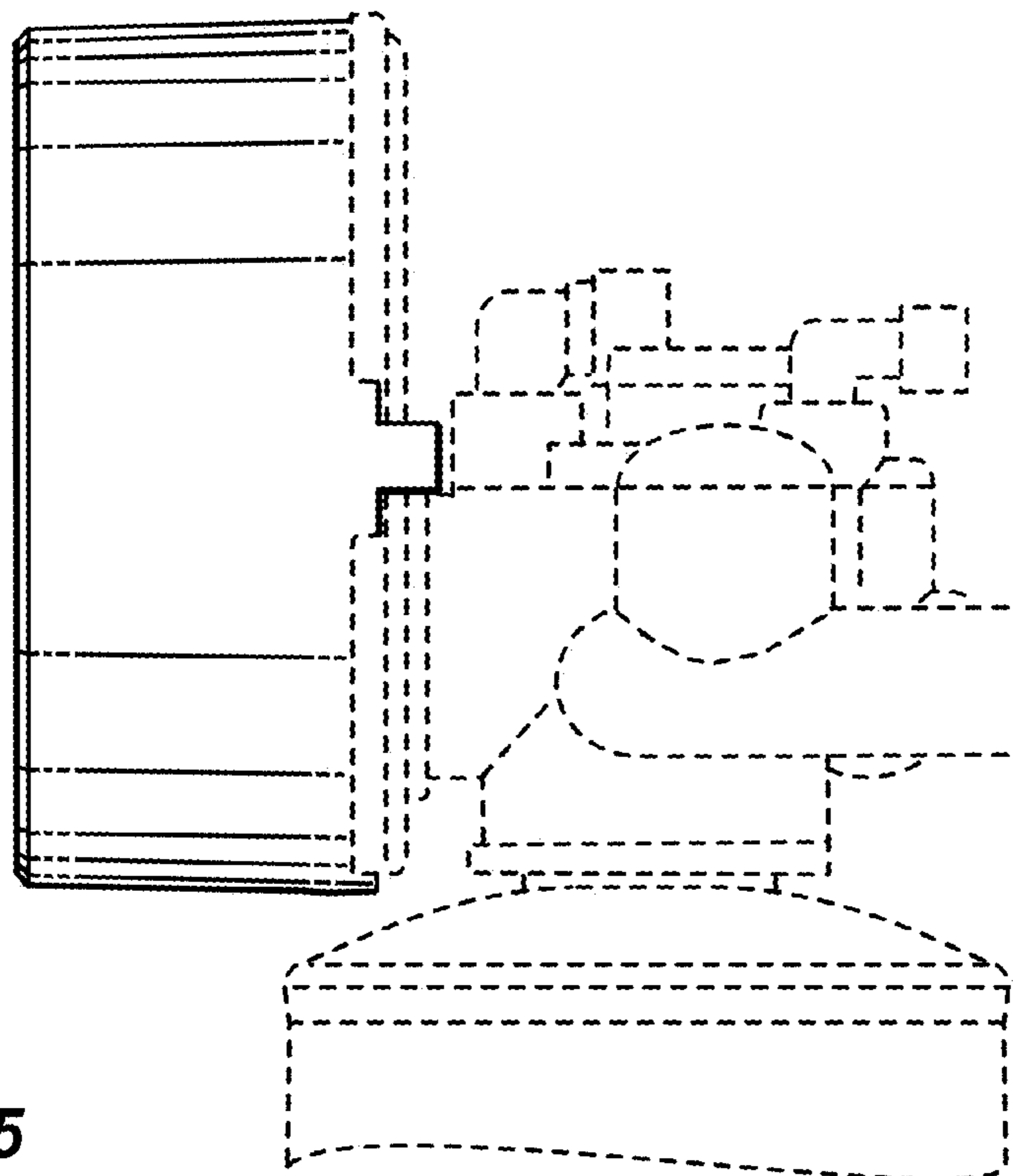

FIG. 5

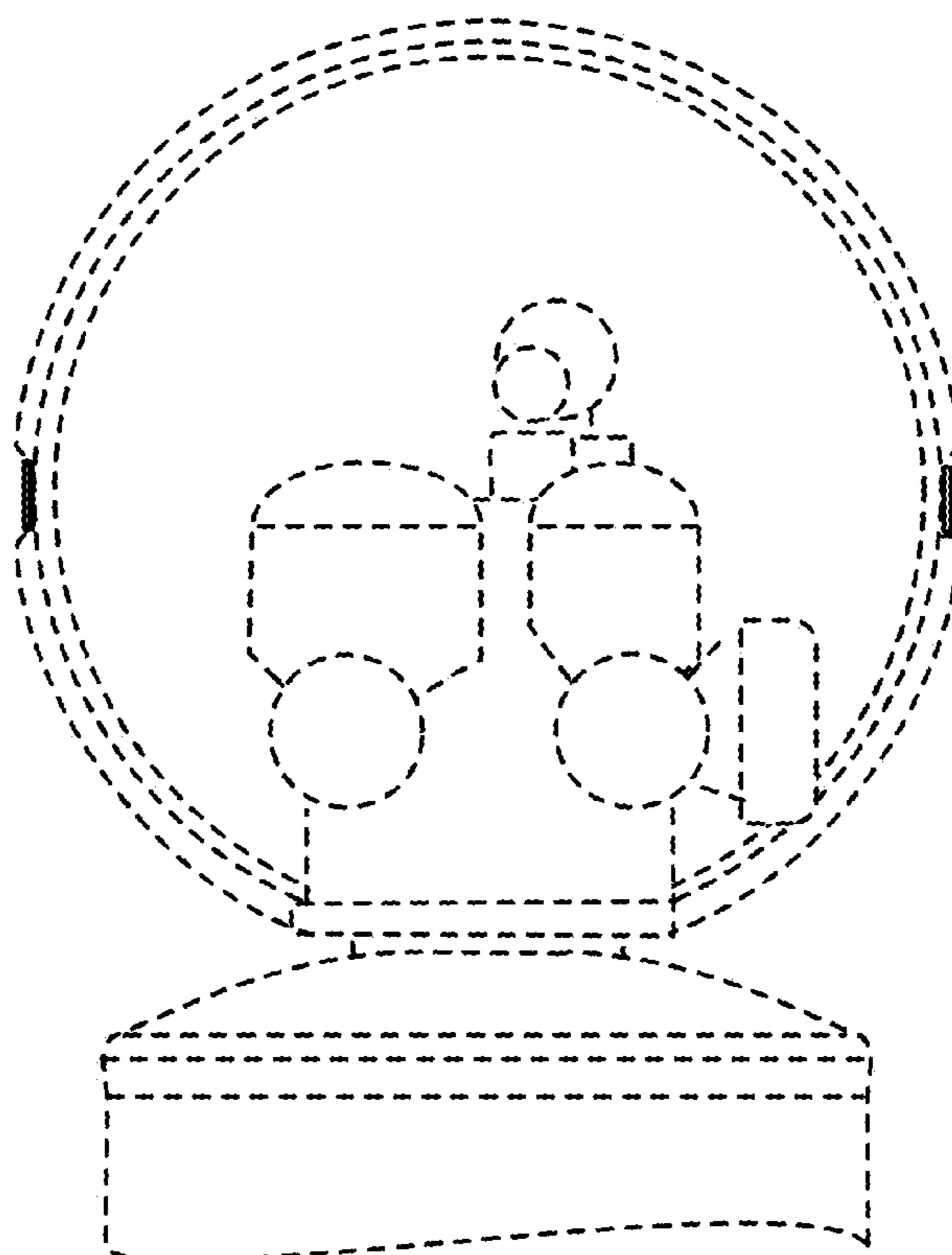

FIG. 6