



US00D727413S

(12) **United States Design Patent**
Katsuyama

(10) **Patent No.:** **US D727,413 S**
(45) **Date of Patent:** **** Apr. 21, 2015**

(54) **PRINTER**

(71) Applicant: **Goro Katsuyama**, Ohta-ku (JP)

(72) Inventor: **Goro Katsuyama**, Ohta-ku (JP)

(73) Assignee: **Ricoh Company, Ltd.**, Tokyo (JP)

(**) Term: **14 Years**

(21) Appl. No.: **29/462,415**

(22) Filed: **Aug. 2, 2013**

(30) **Foreign Application Priority Data**

Feb. 4, 2013 (JP) 2013-002090

(51) **LOC (10) Cl.** **18-02**

(52) **U.S. Cl.**
USPC **D18/53**

(58) **Field of Classification Search**
CPC ... G06K 15/12; G06K 15/14; H04N 1/00204;
H04N 1/00249; H04N 1/00278
USPC D18/53, 56, 59, 36, 38, 39, 40, 41, 45;
D14/301, 307; 399/16, 75, 81, 131,
399/151, 361, 365, 367, 381-385, 388
See application file for complete search history.

(56) **References Cited**

U.S. PATENT DOCUMENTS

D390,256 S * 2/1998 Shibata D18/39
6,647,222 B1 * 11/2003 Digby et al. 399/81
6,725,001 B2 * 4/2004 Takahashi et al. 399/81

6,865,353 B2 * 3/2005 Fujita et al. 399/81
D521,056 S * 5/2006 Horiguchi et al. D18/39
D535,686 S * 1/2007 Ishio D18/39
D557,738 S * 12/2007 Falk D18/53
D626,588 S * 11/2010 Kim et al. D18/39
D685,414 S * 7/2013 Jeong et al. D18/53
D692,477 S * 10/2013 Kim et al. D18/53
D695,339 S * 12/2013 Fukasawa et al. D18/55
D701,563 S * 3/2014 Kim et al. D18/53

OTHER PUBLICATIONS

U.S. Appl. No. 29/462,416, filed Aug. 2, 2013, Katsuyama et al.
U.S. Appl. No. 29/462,416, filed Aug. 2, 2013.

* cited by examiner

Primary Examiner — Bridget L Eland

(74) *Attorney, Agent, or Firm* — Oblon, McClelland, Maier & Neustadt, L.L.P.

(57) **CLAIM**

The ornamental design for a printer, as shown and described.

DESCRIPTION

FIG. 1 is a front elevational view of a printer;
FIG. 2 is a rear elevational view thereof;
FIG. 3 is a left side elevational view thereof;
FIG. 4 is a right side elevational view thereof;
FIG. 5 is a top plan view thereof;
FIG. 6 is a bottom plan view thereof; and,
FIG. 7 is a front, top, and right side perspective view thereof.
The broken lines in the drawings depict environmental subject matter only and form no part of the claimed design.

1 Claim, 7 Drawing Sheets

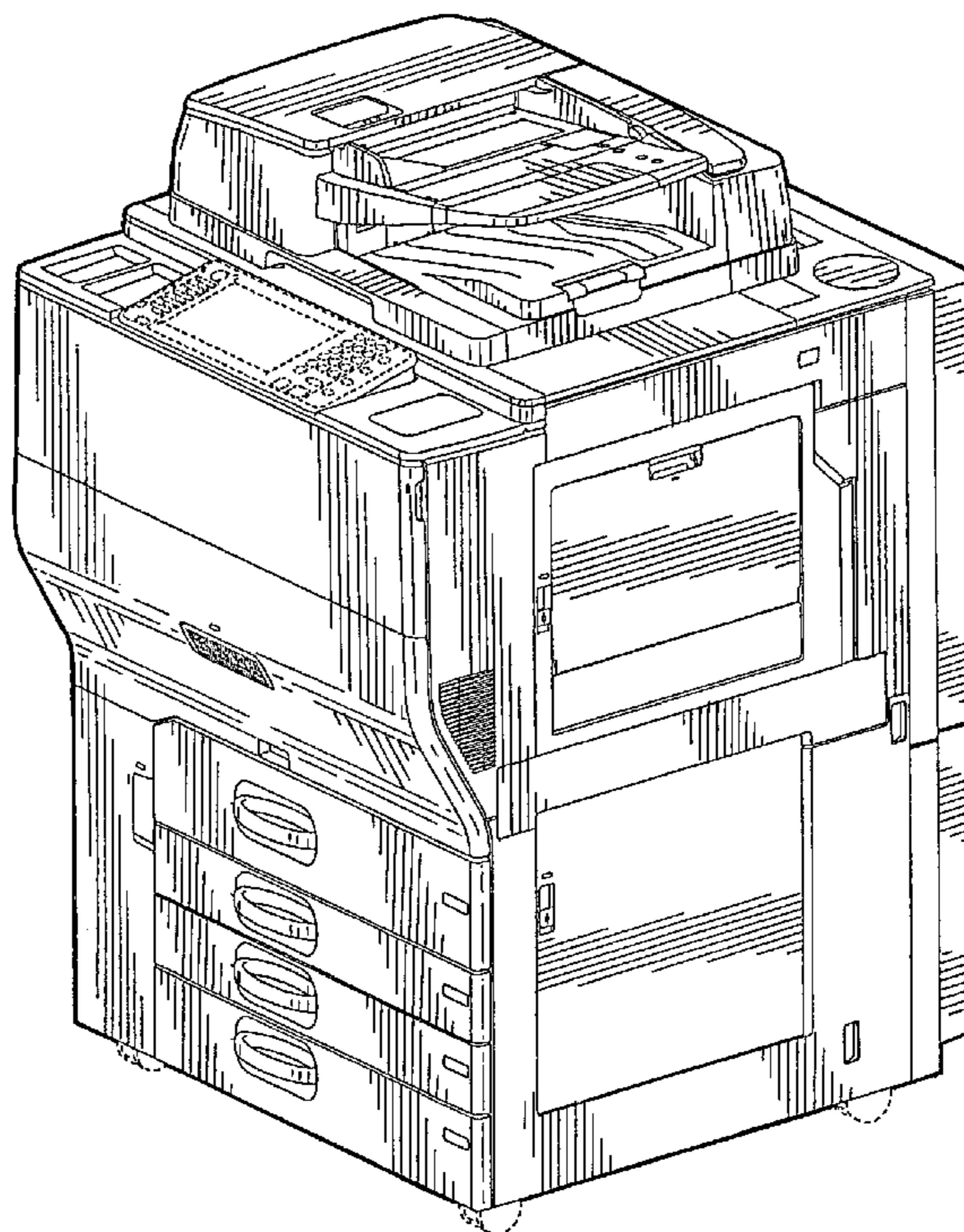
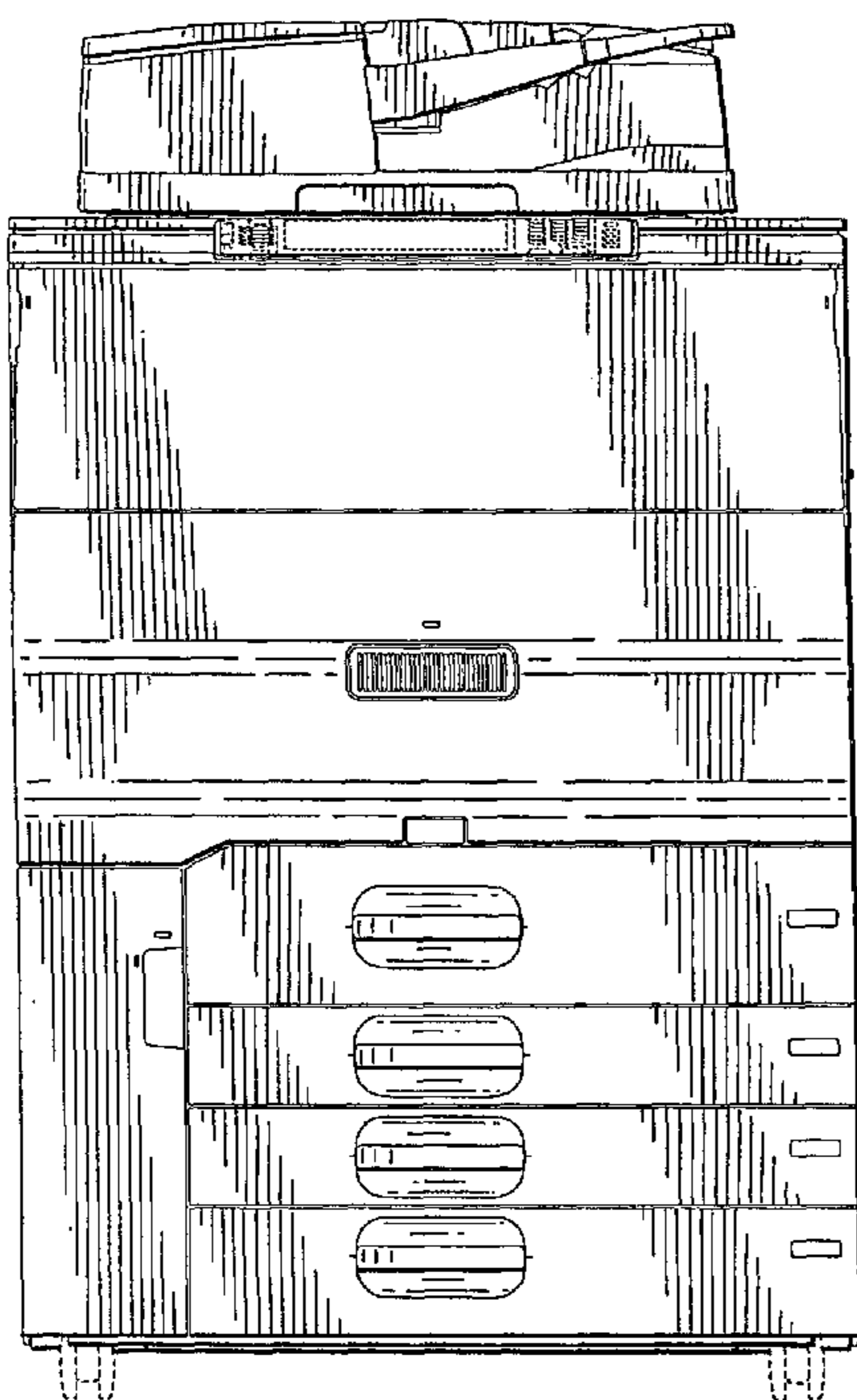

FIG. 1

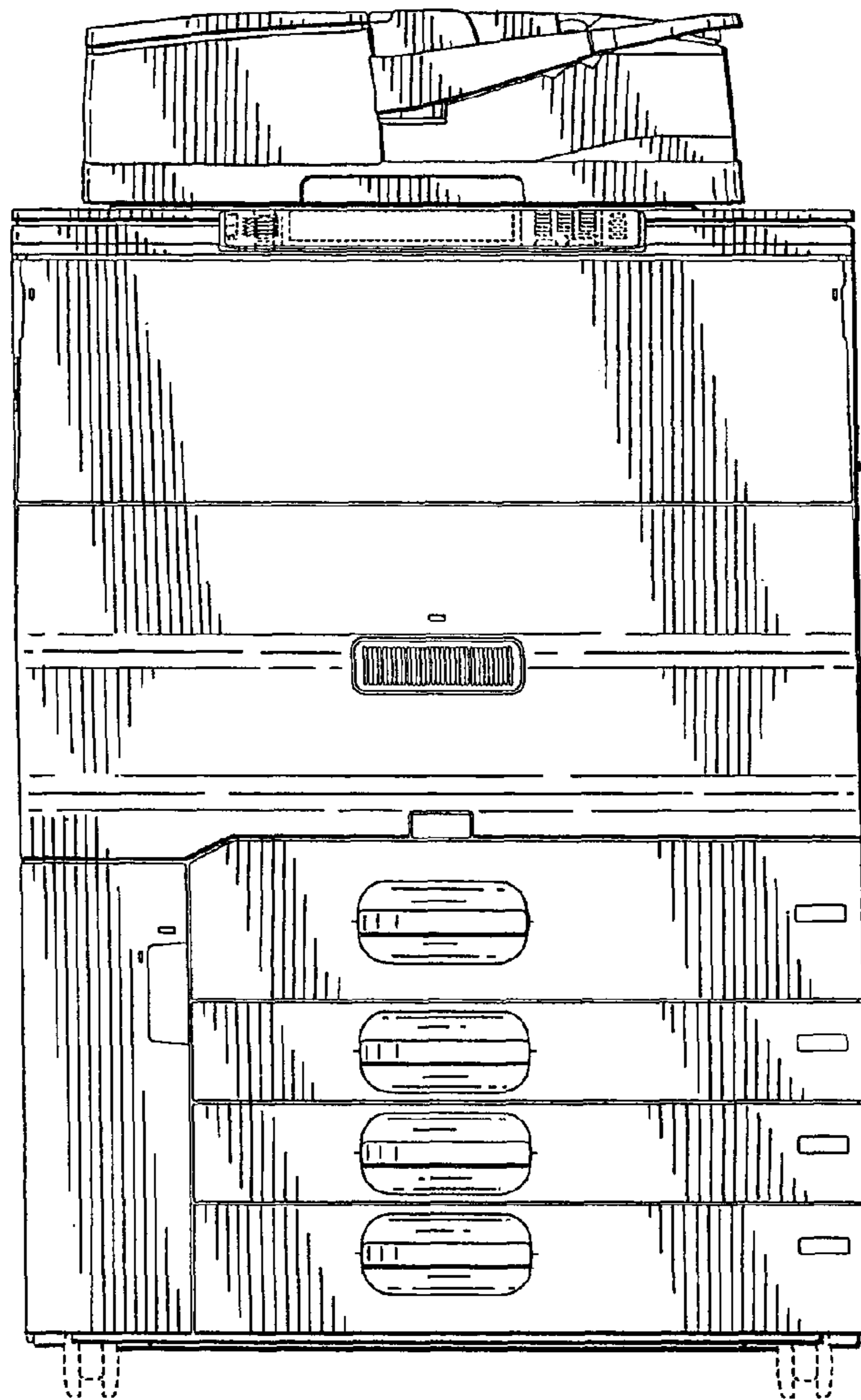

FIG.2

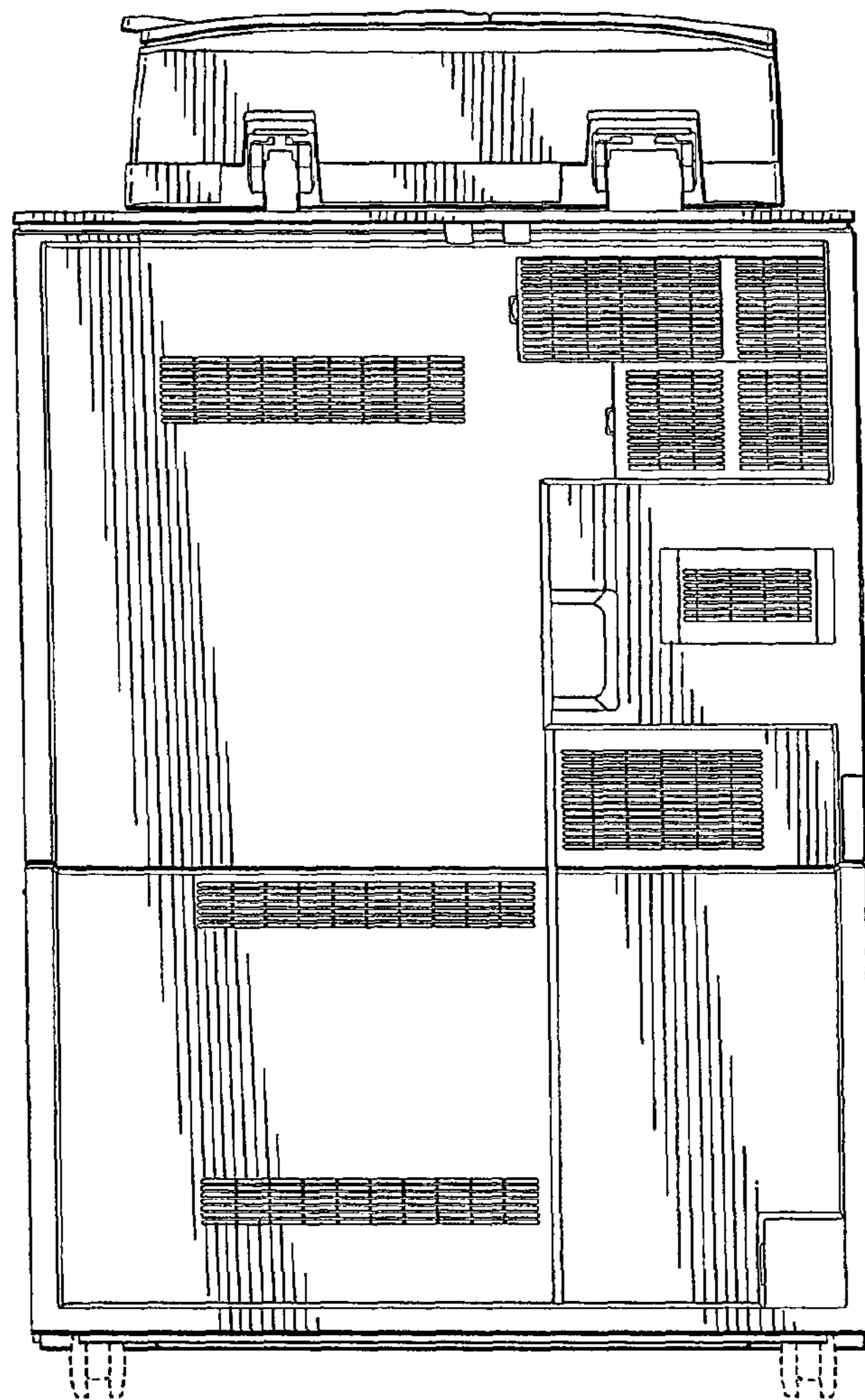

FIG.3

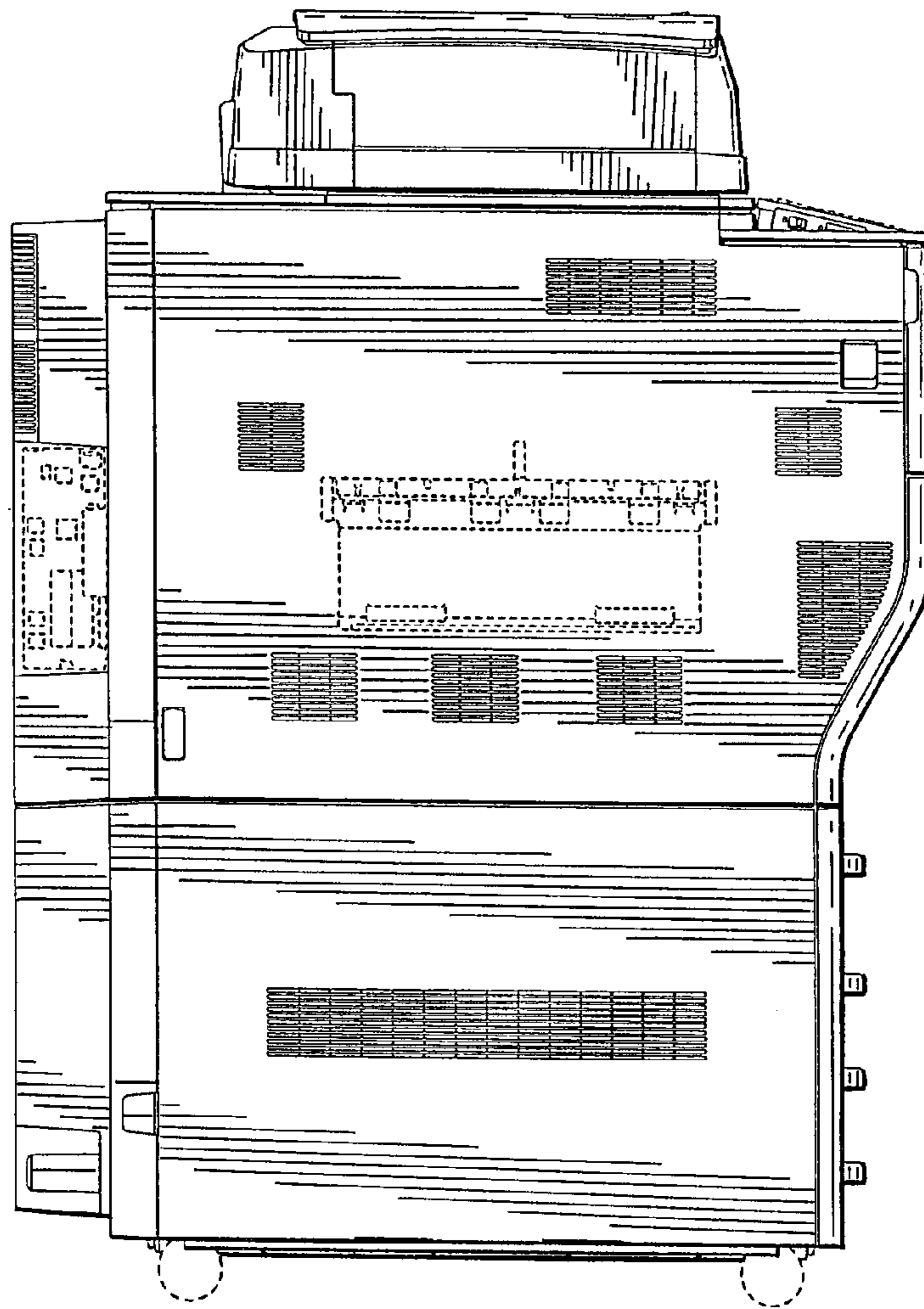

FIG.4

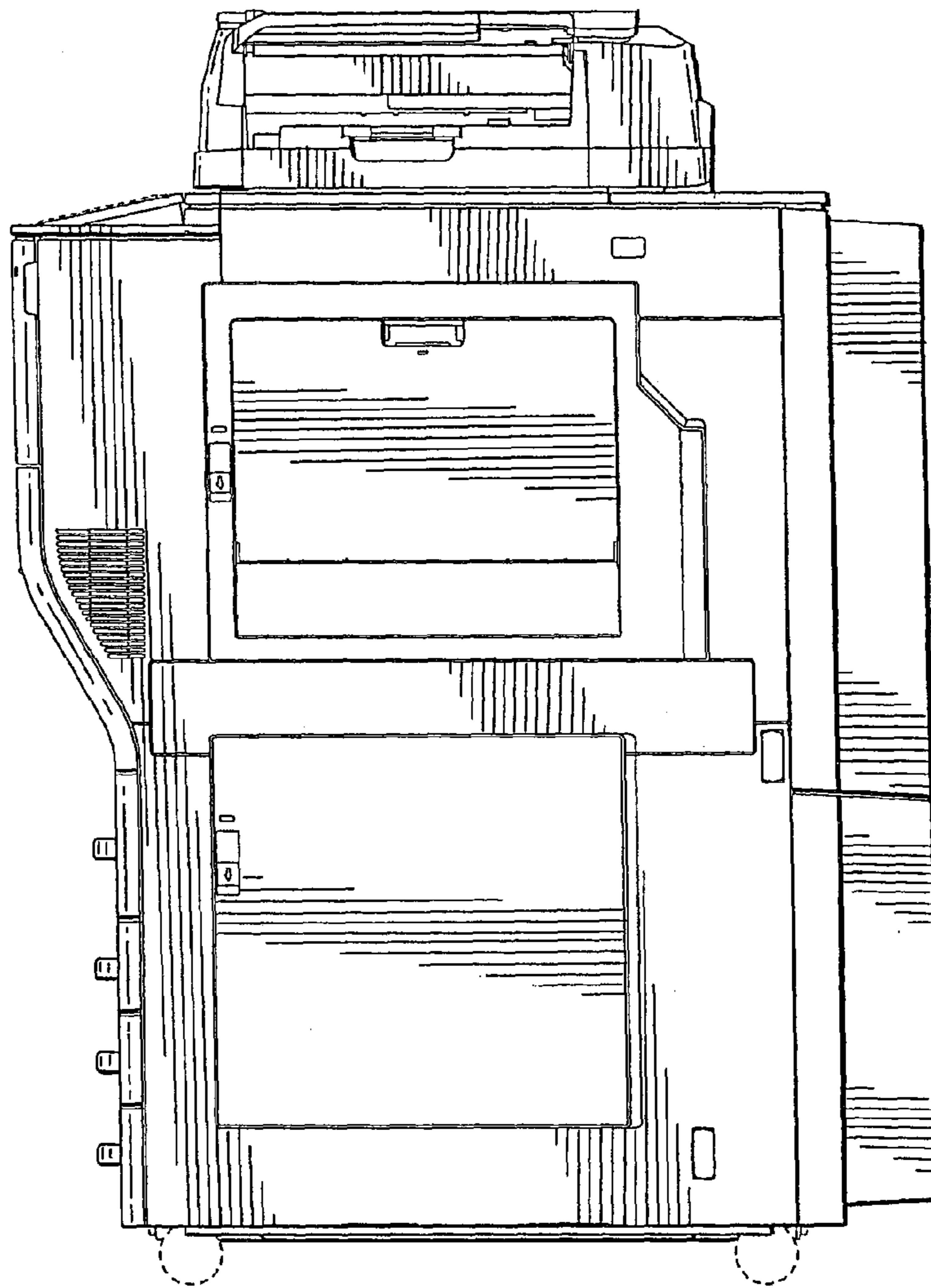

FIG.5

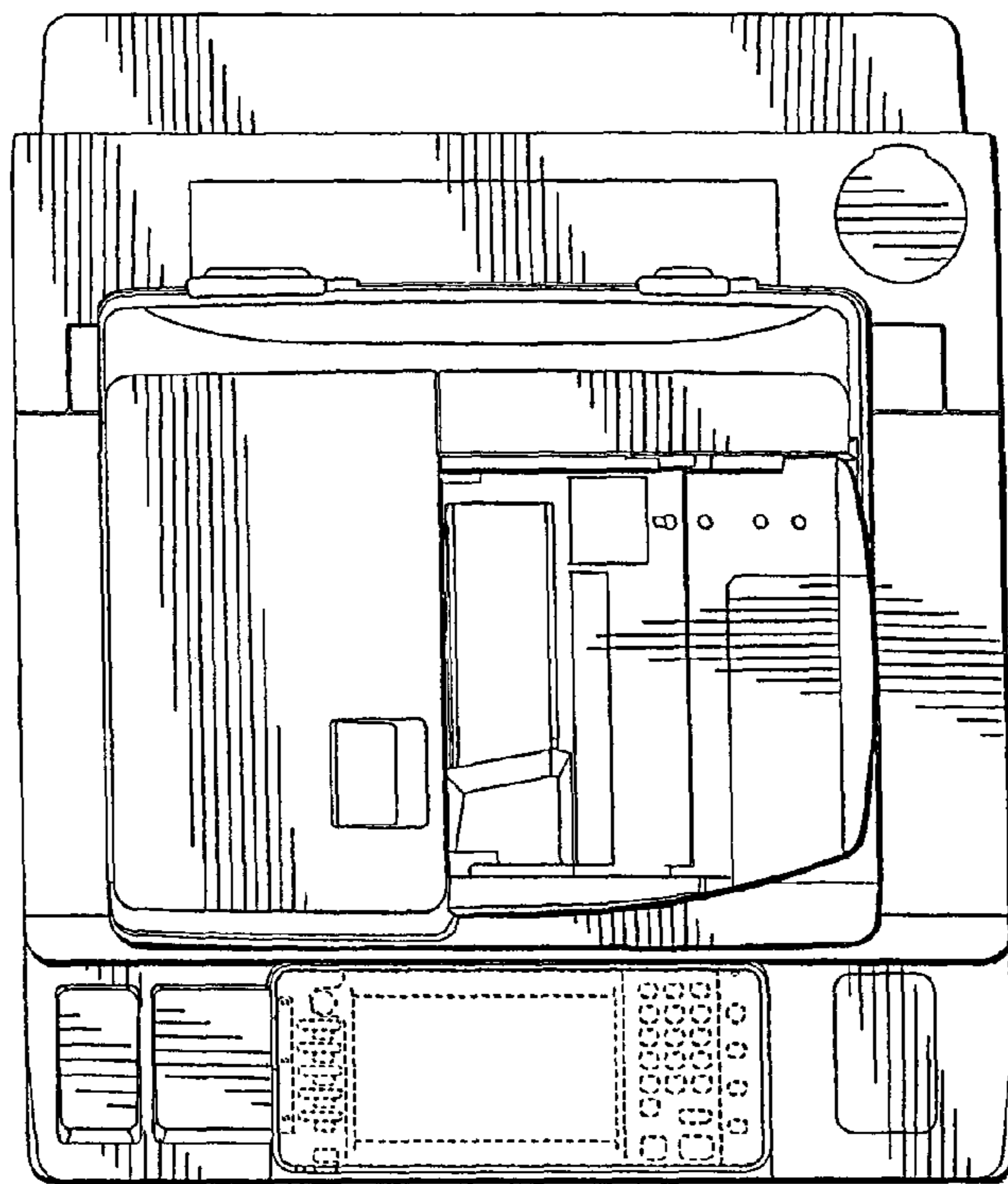

FIG.6

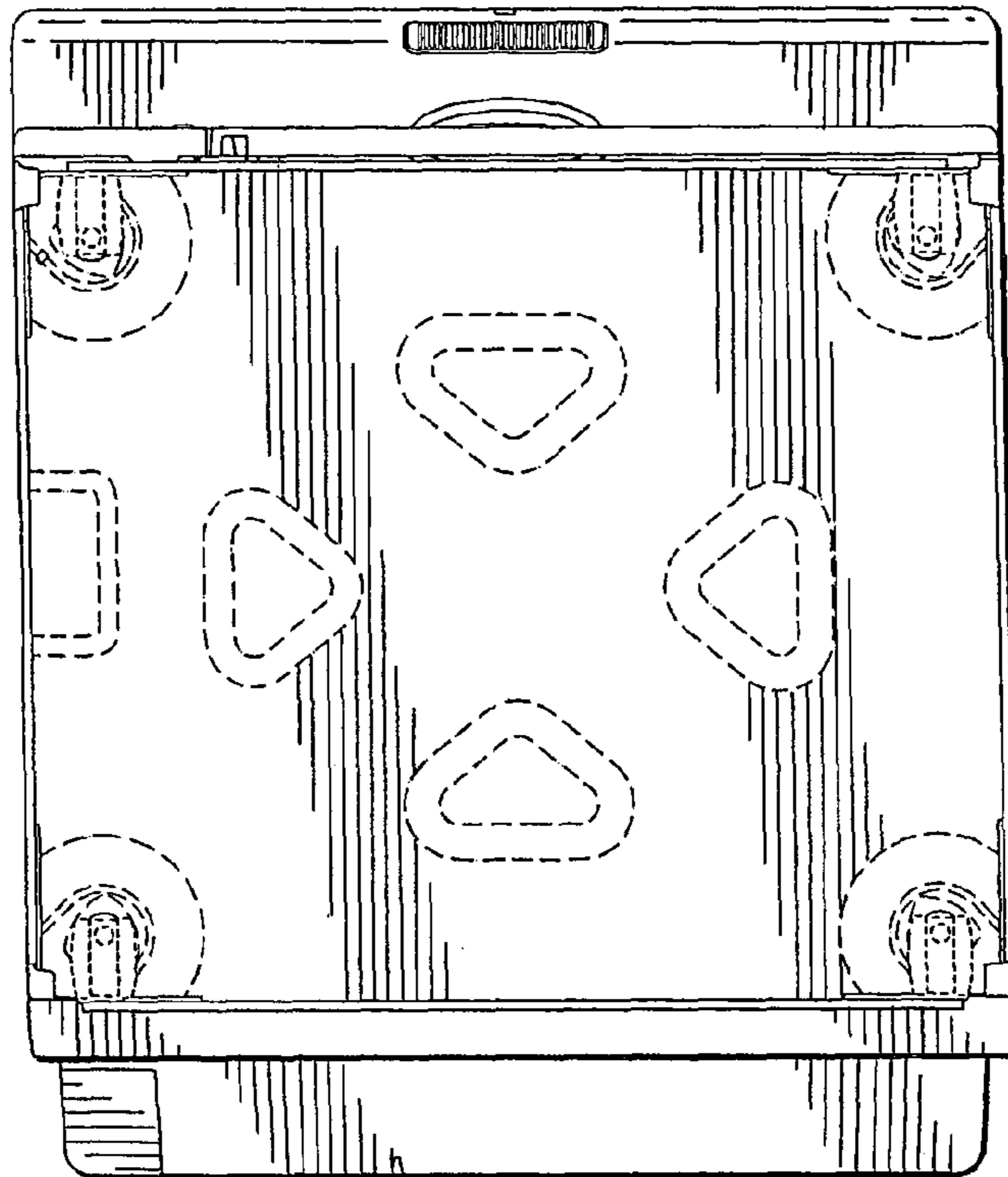

FIG. 7

