



US00D727412S

(12) **United States Design Patent**
Oda et al.

(10) **Patent No.:** **US D727,412 S**
(45) **Date of Patent:** **** Apr. 21, 2015**

(54) **TONER CARTRIDGE**

(71) Applicant: **OKI Data Corporation**, Tokyo (JP)

(72) Inventors: **Yukiyoshi Oda**, Tokyo (JP); **Shigenori Koido**, Tokyo (JP); **Shinichi Otani**, Tokyo (JP)

(73) Assignee: **OKI Data Corporation**, Tokyo (JP)

(**) Term: **14 Years**

(21) Appl. No.: **29/479,002**

(22) Filed: **Jan. 10, 2014**

(30) **Foreign Application Priority Data**

Jul. 12, 2013 (JP) 2013-015965

(51) **LOC (10) Cl.** **16-03**

(52) **U.S. Cl.**
USPC **D18/43**

(58) **Field of Classification Search**
CPC G03G 15/0832; G03G 15/0834; G03G 15/0836; G03G 15/0837; G03G 15/0867; G03G 15/0868; G03G 15/0872; G03G 15/0881; G03G 15/0886; G03G 15/0877; G03G 15/0898; G03G 15/50; G03G 15/5016; G03G 225/0668
USPC D14/471; D18/12, 36, 40, 43, 44, 50, D18/55, 56, 99; 347/49, 50, 197, 222; 399/11, 106, 119, 120, 230, 258, 262
See application file for complete search history.

(56) **References Cited**

U.S. PATENT DOCUMENTS

D637,225	S	*	5/2011	Kishi et al.	D18/43
D645,077	S	*	9/2011	Murata	D18/43
D650,413	S	*	12/2011	Murata	D18/43
D650,415	S	*	12/2011	Murata	D18/43
2014/0140735	A1	*	5/2014	Oda	399/258
2014/0212151	A1	*	7/2014	Oda	399/12
2014/0212182	A1	*	7/2014	Oda	399/258

* cited by examiner

Primary Examiner — Sheryl Lane

Assistant Examiner — Amy Wierenga

(74) *Attorney, Agent, or Firm* — Ladas & Parry LLP

(57) **CLAIM**

The ornamental design for a toner cartridge, as shown and described.

DESCRIPTION

FIG. 1 is a front view of a toner cartridge showing our new design;
FIG. 2 is a right side view thereof;
FIG. 3 is a top plan view thereof;
FIG. 4 is a left-side view thereof;
FIG. 5 is a bottom plan view thereof;
FIG. 6 is a rear view thereof; and,
FIG. 7 is a perspective view thereof.
The broken lines in the drawings depict environmental subject matter only and form no part of the claimed design.

1 Claim, 7 Drawing Sheets

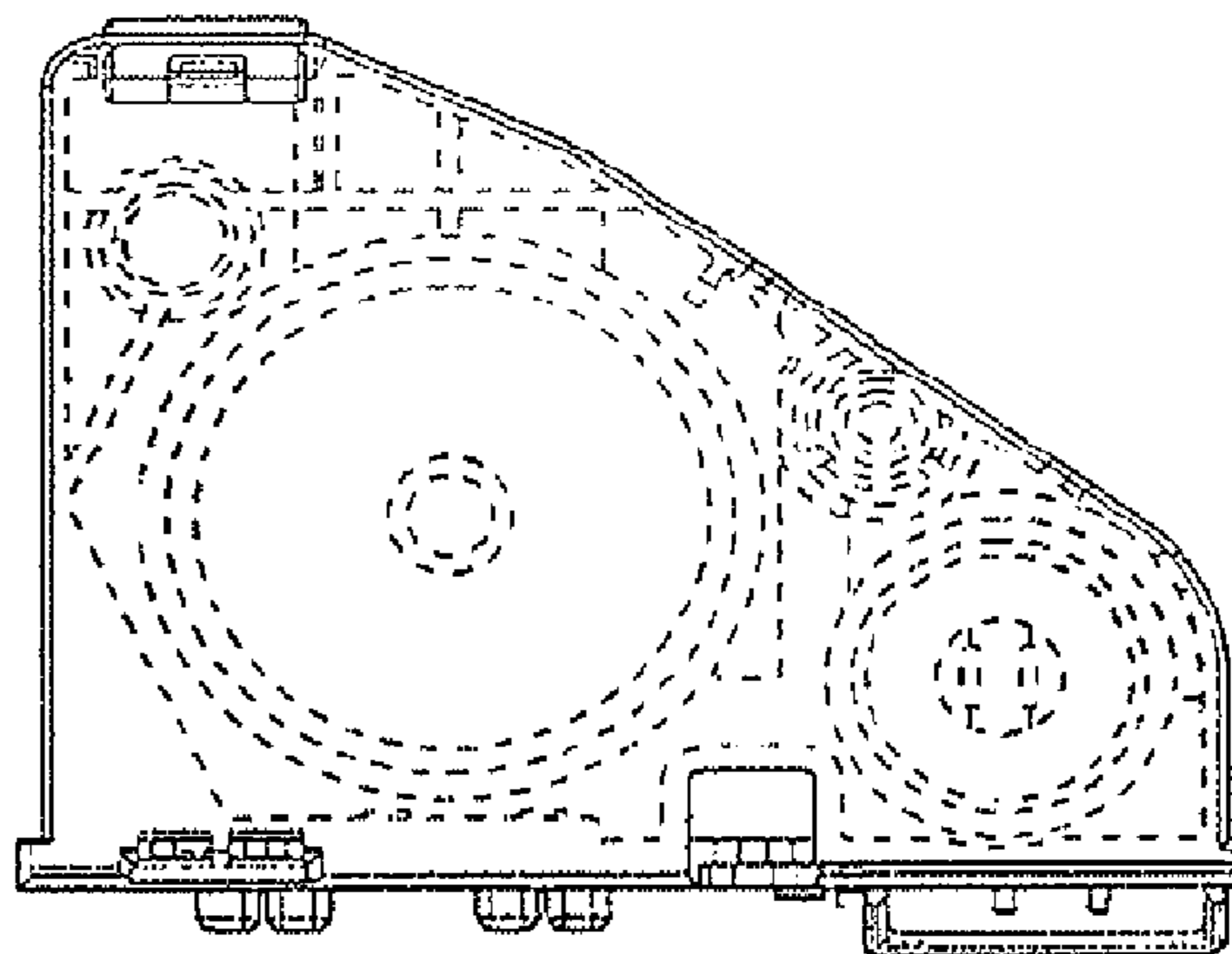
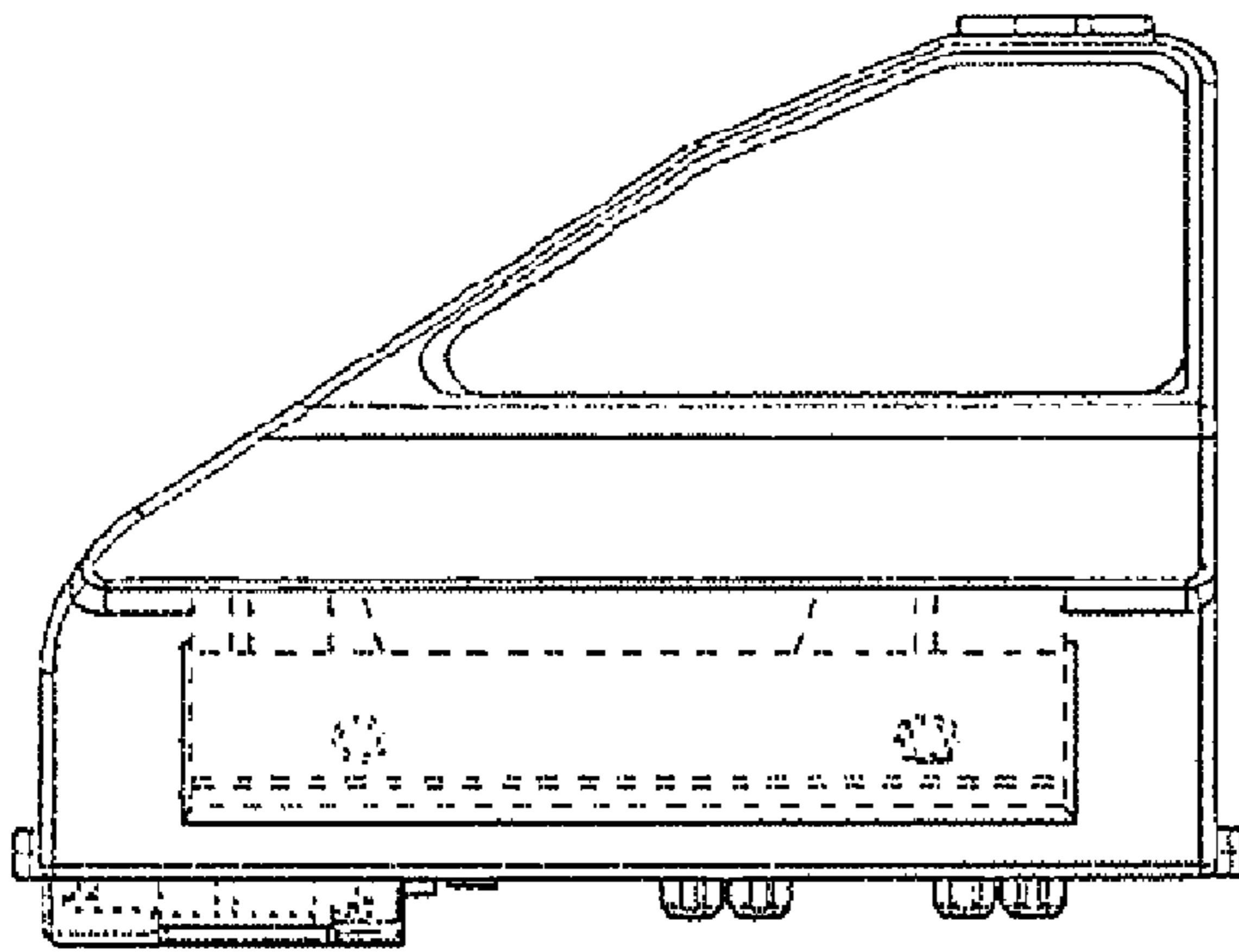

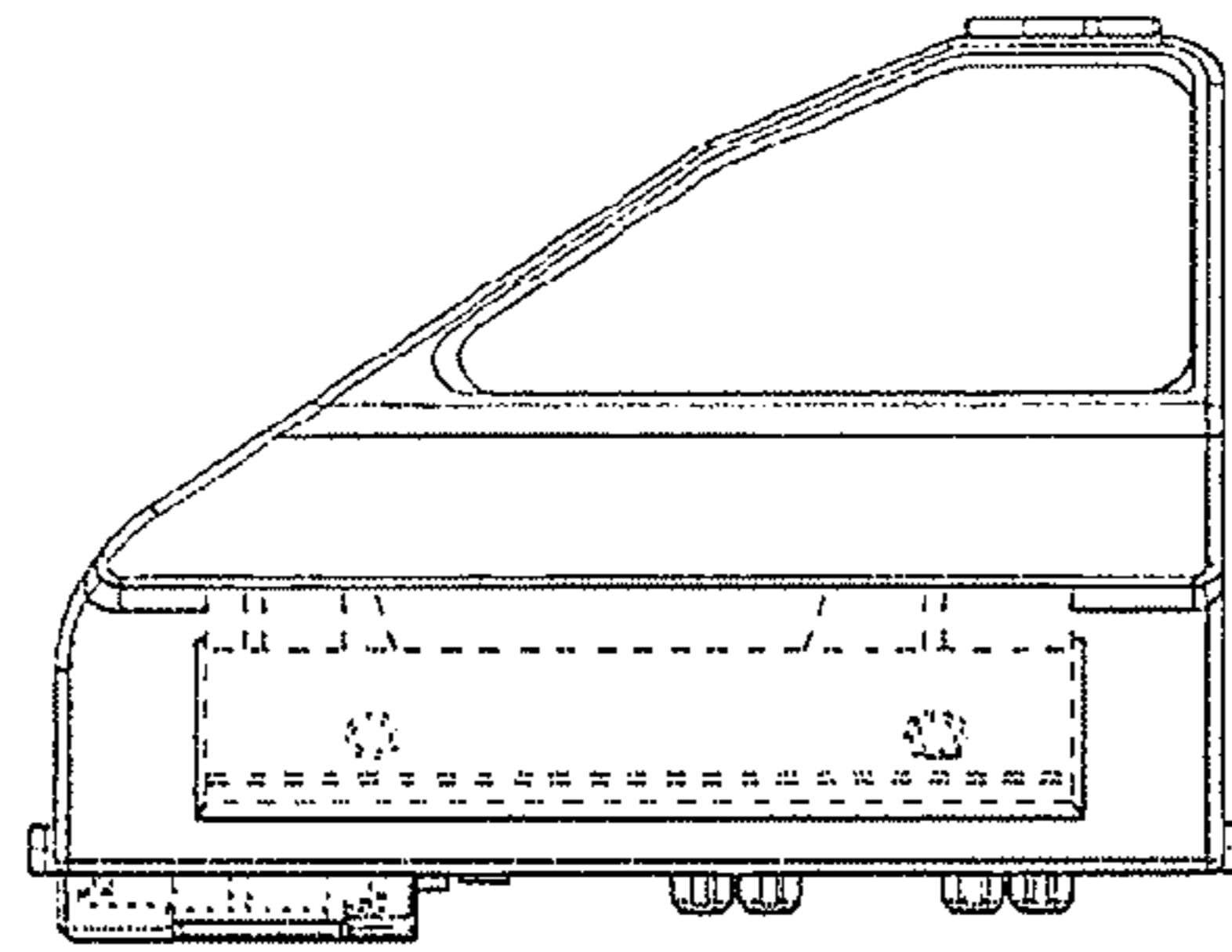

FIG. 1

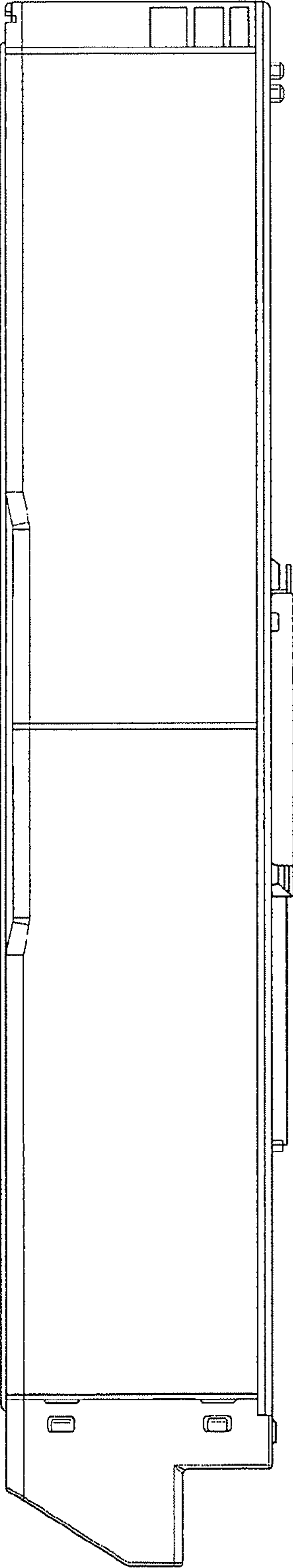

FIG. 2

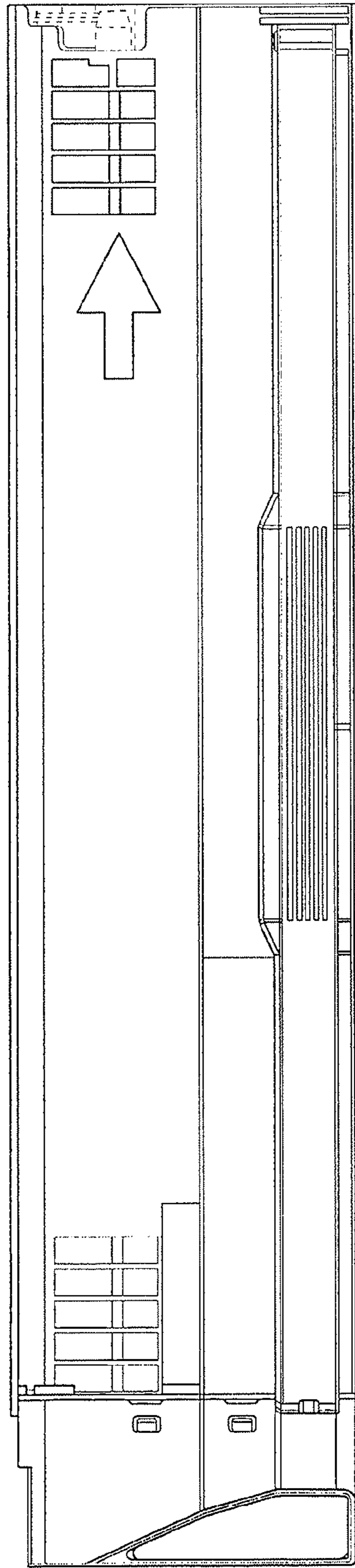

FIG. 3

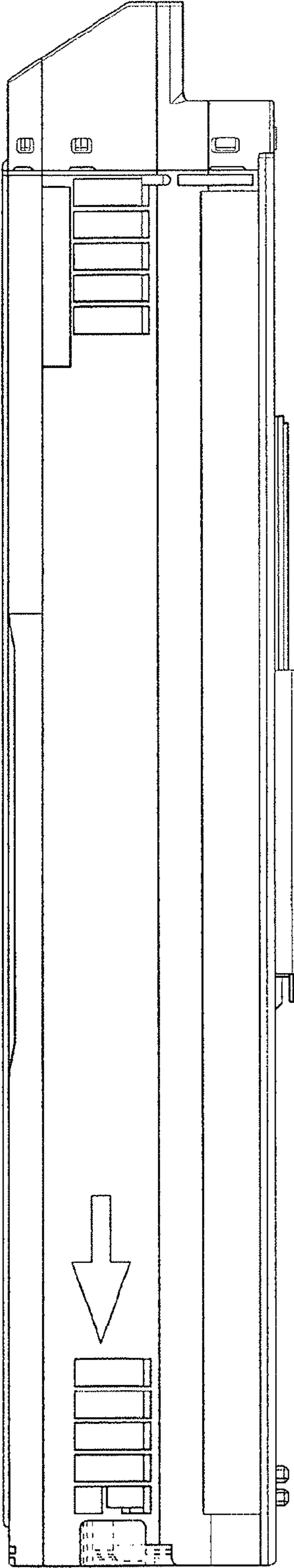

FIG. 4

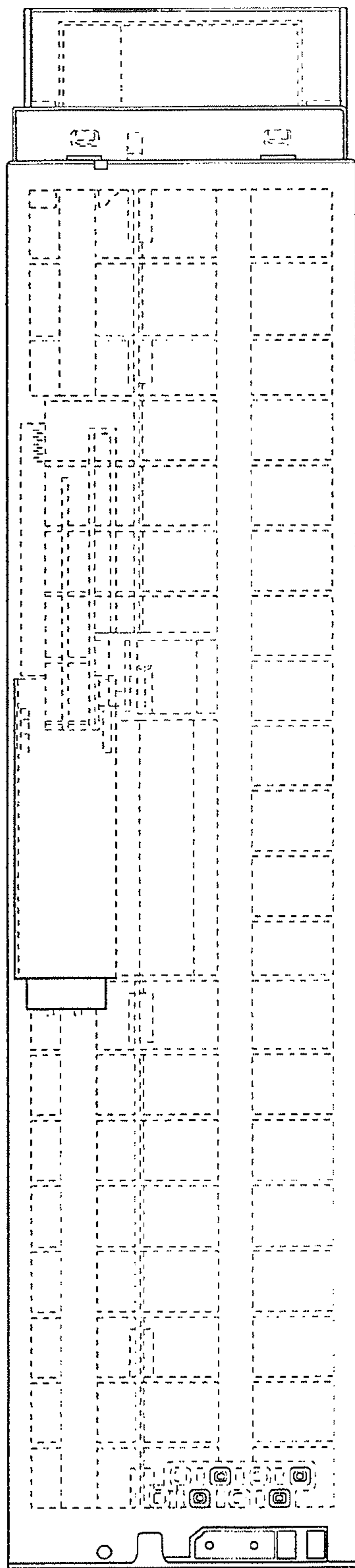

FIG. 5

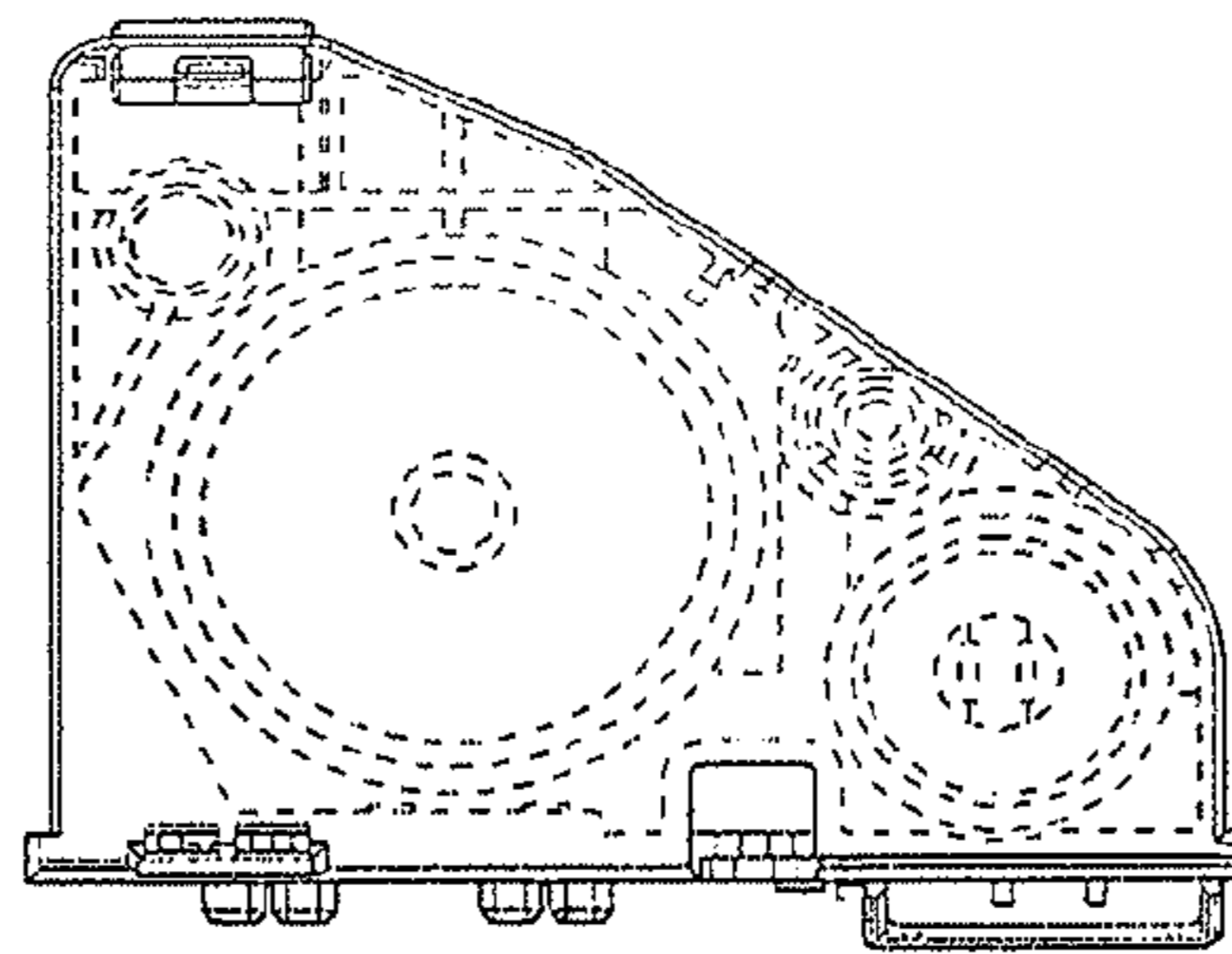

FIG. 6

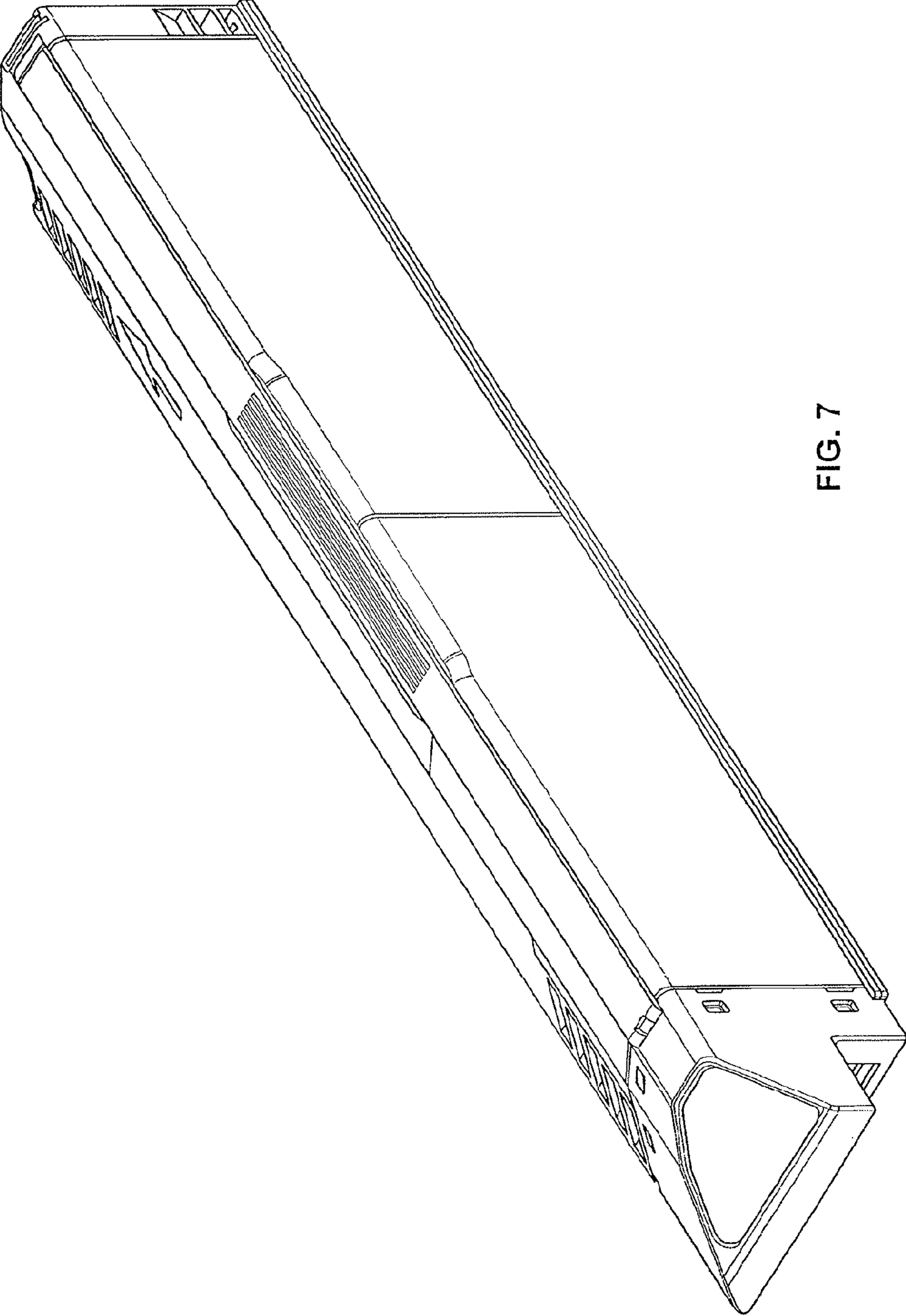

FIG. 7