



US00D727405S

(12) **United States Design Patent**
Damin et al.

(10) **Patent No.:** **US D727,405 S**

(45) **Date of Patent:** **** Apr. 21, 2015**

(54) **PAIR OF GLASSES**

D697,963 S * 1/2014 Earley D16/326
D710,432 S * 8/2014 Votel et al. D16/326

(71) Applicant: **Smith Optics, Inc.**, Ketchum, ID (US)

OTHER PUBLICATIONS

(72) Inventors: **Marco Damin**, Pianiga (IT); **Michael Aaskov**, Ketchum, ID (US); **George T Giroux**, Ketchum, ID (US)

<http://www.smithoptics.com/Root/Men's/Sunglasses/New/PIVLOCK-OVERDRIVE/p/OVPCDMBK>, Sep. 2013.

(73) Assignee: **Smith Optics, Inc.**, Ketchum, ID (US)

* cited by examiner

(**) Term: **14 Years**

Primary Examiner — Raphael Barkai

(21) Appl. No.: **29/494,252**

(74) *Attorney, Agent, or Firm* — Dorsey & Whitney LLP

(22) Filed: **Jun. 18, 2014**

(51) **LOC (10) Cl.** **16-06**

(52) **U.S. Cl.**
USPC **D16/326; D16/335**

(58) **Field of Classification Search**
CPC G02C 2200/08; G02C 1/06
USPC D16/101, 300–342, 900; D29/109–110;
351/41, 44, 51–52, 62, 158, 92,
351/103–123, 140–153, 63, 59, 45–46;
2/426–432, 447–449, 441, 434–437,
2/13, 15; D21/483, 659–661; D14/372
See application file for complete search history.

(57) **CLAIM**

The ornamental design of the pair of glasses, as shown and described.

DESCRIPTION

FIG. 1 is a side-front view of a pair of glasses;
FIG. 2 is a side view of the pair of glasses of FIG. 1;
FIG. 3 is a rear view of the pair of glasses of FIG. 1;
FIG. 4 is a rear view of the pair of glasses of FIG. 1;
FIG. 5 is a side view of the pair of glasses of FIG. 1;
FIG. 6 is a bottom view of the pair of glasses of FIG. 1;
FIG. 7 is a top view of the pair of glasses of FIG. 1; and,
FIG. 8 is a front view of the pair of glasses of FIG. 1.
Any broken lines provided are for illustrative purposes only, and form no part of the claimed design. In addition, any shading provided are for illustrative purposes only, and do not form any portion of the claimed design.

(56) **References Cited**

U.S. PATENT DOCUMENTS

D663,764 S * 7/2012 Serlenga D16/326
D685,409 S * 7/2013 Sheldon D16/315

1 Claim, 8 Drawing Sheets

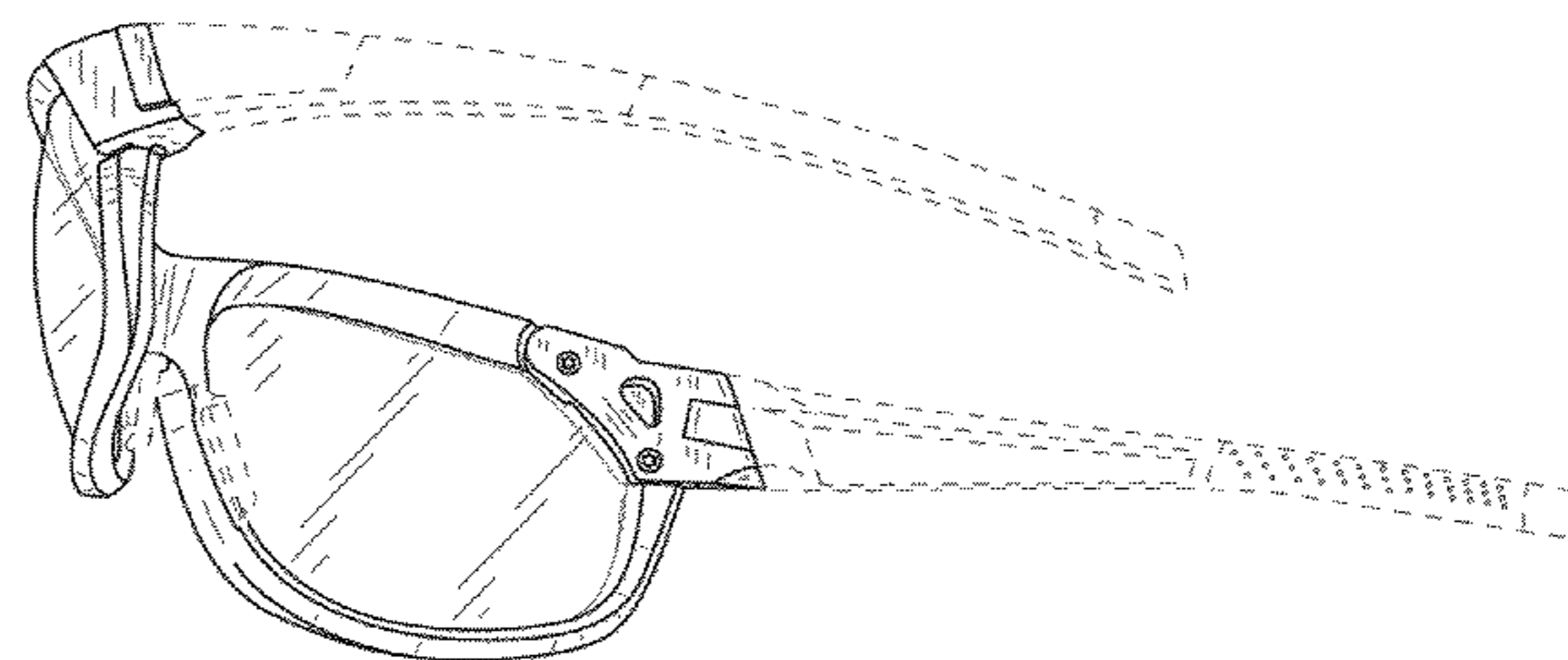
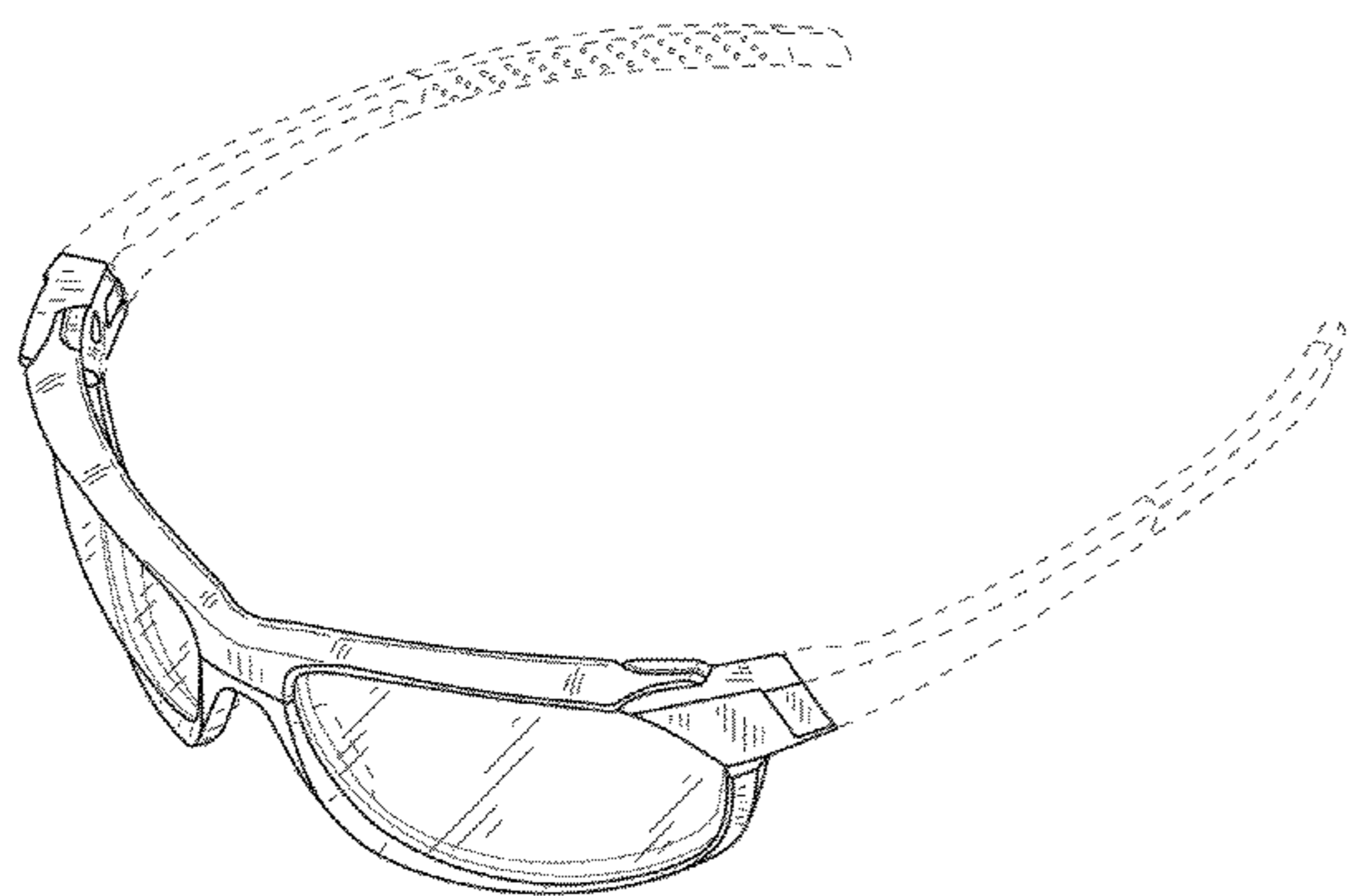

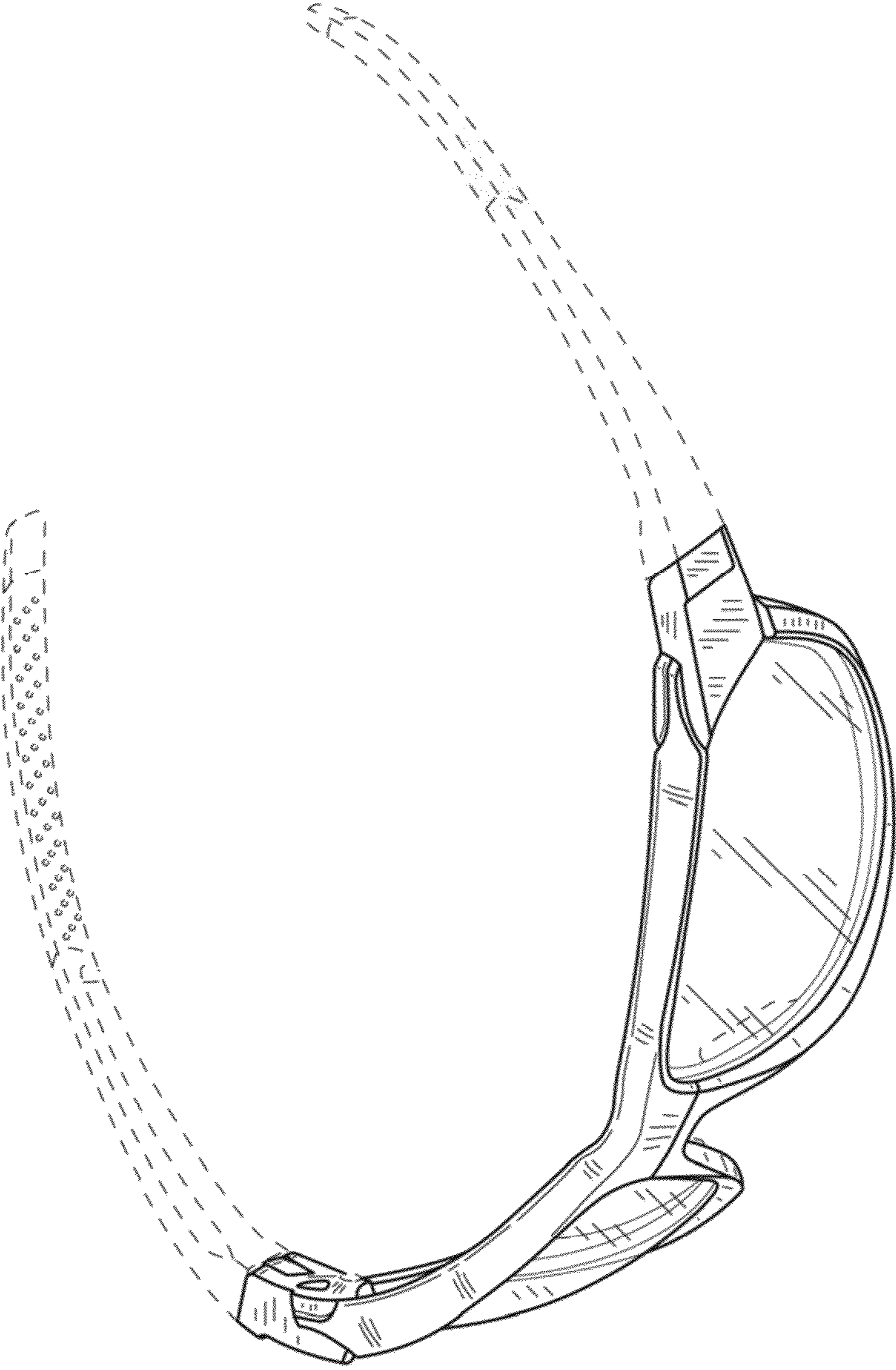

FIG.1

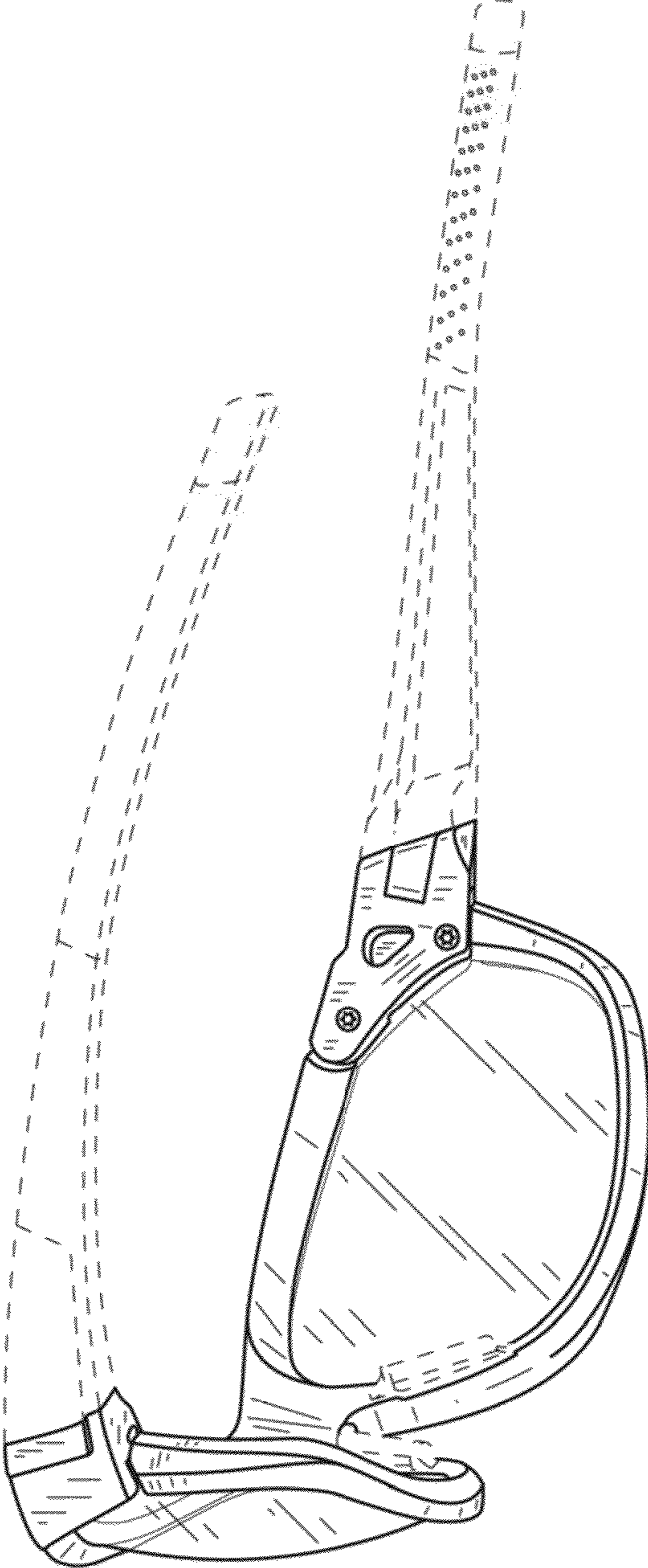

FIG.2

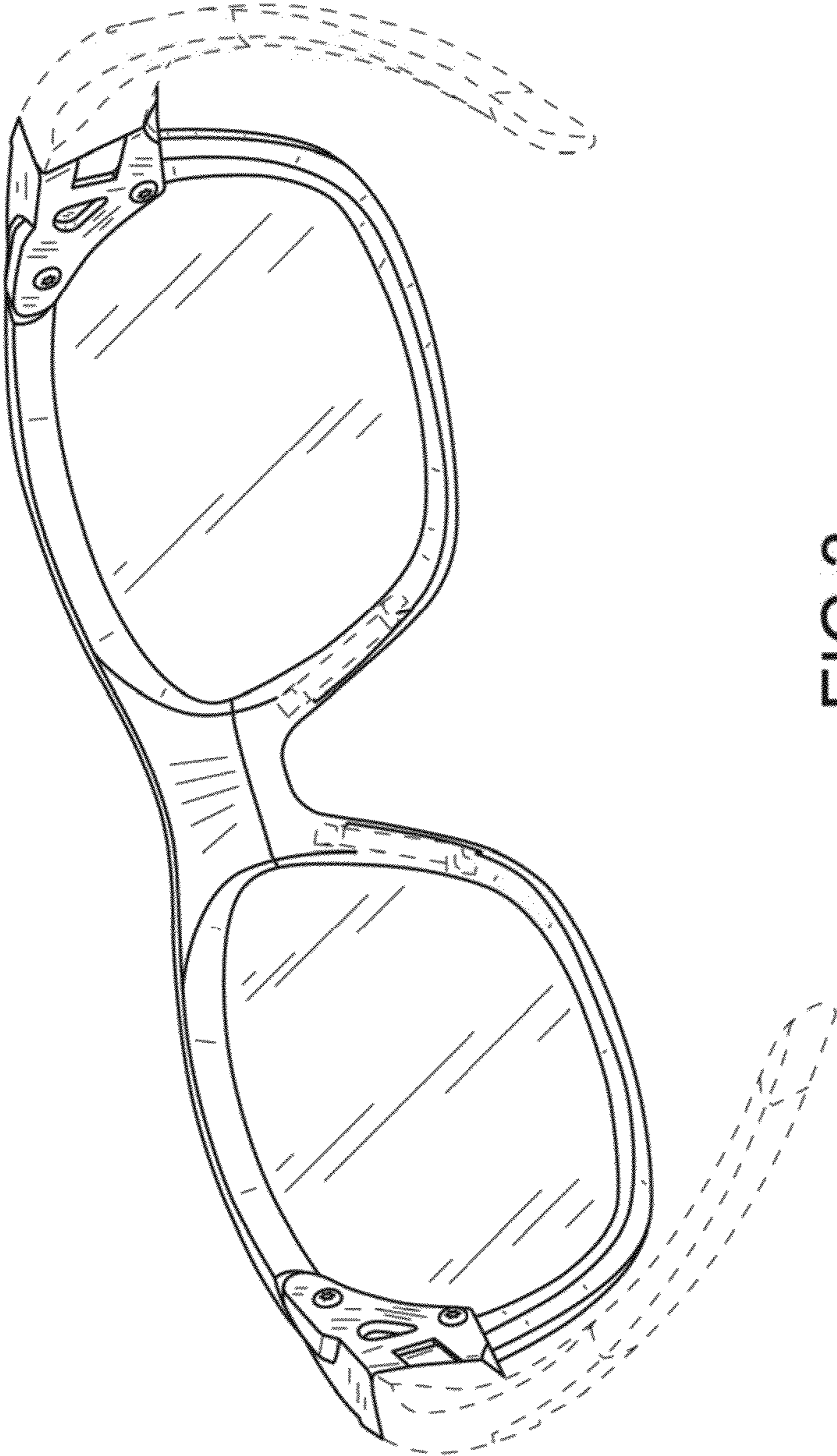

FIG. 3

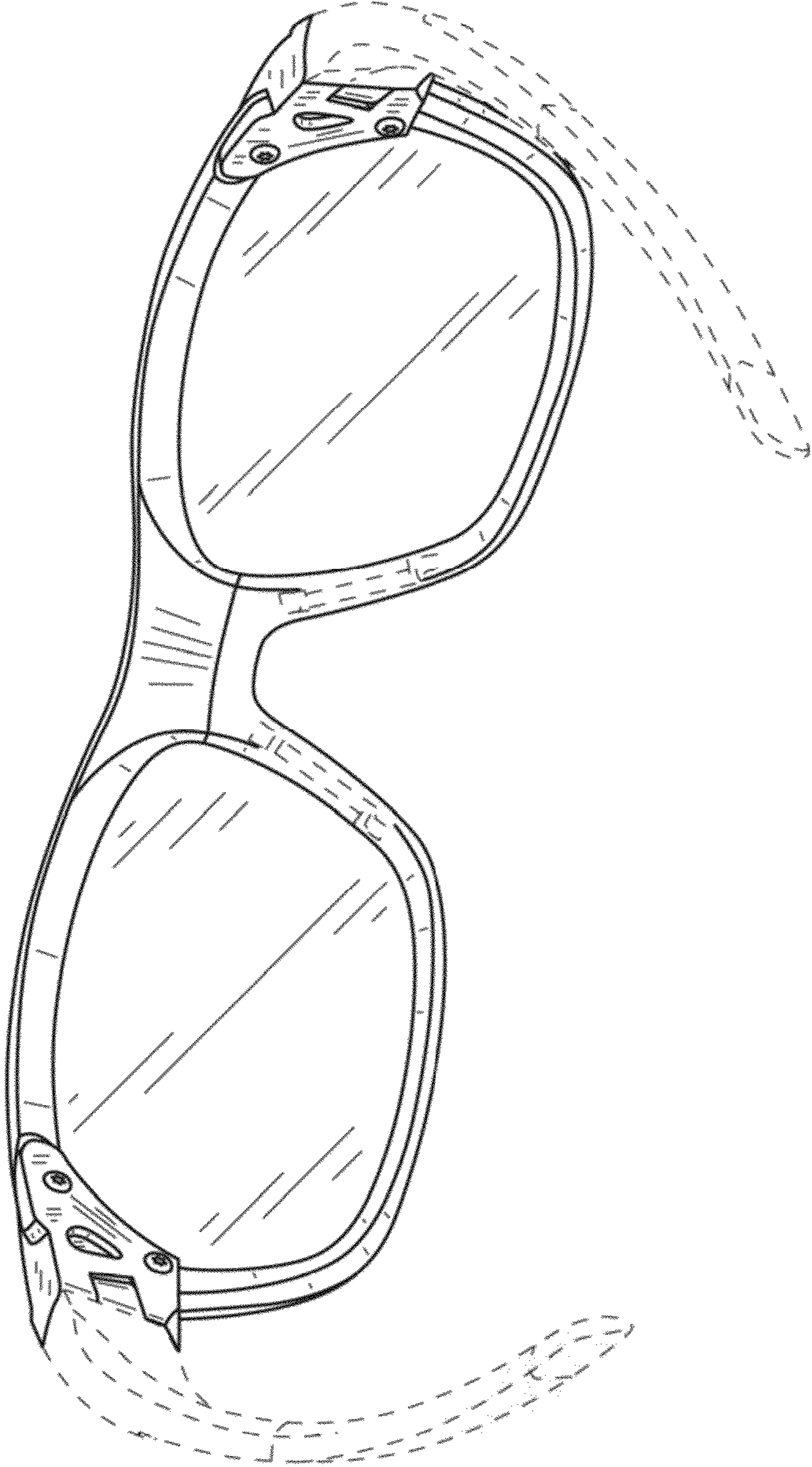

FIG.4

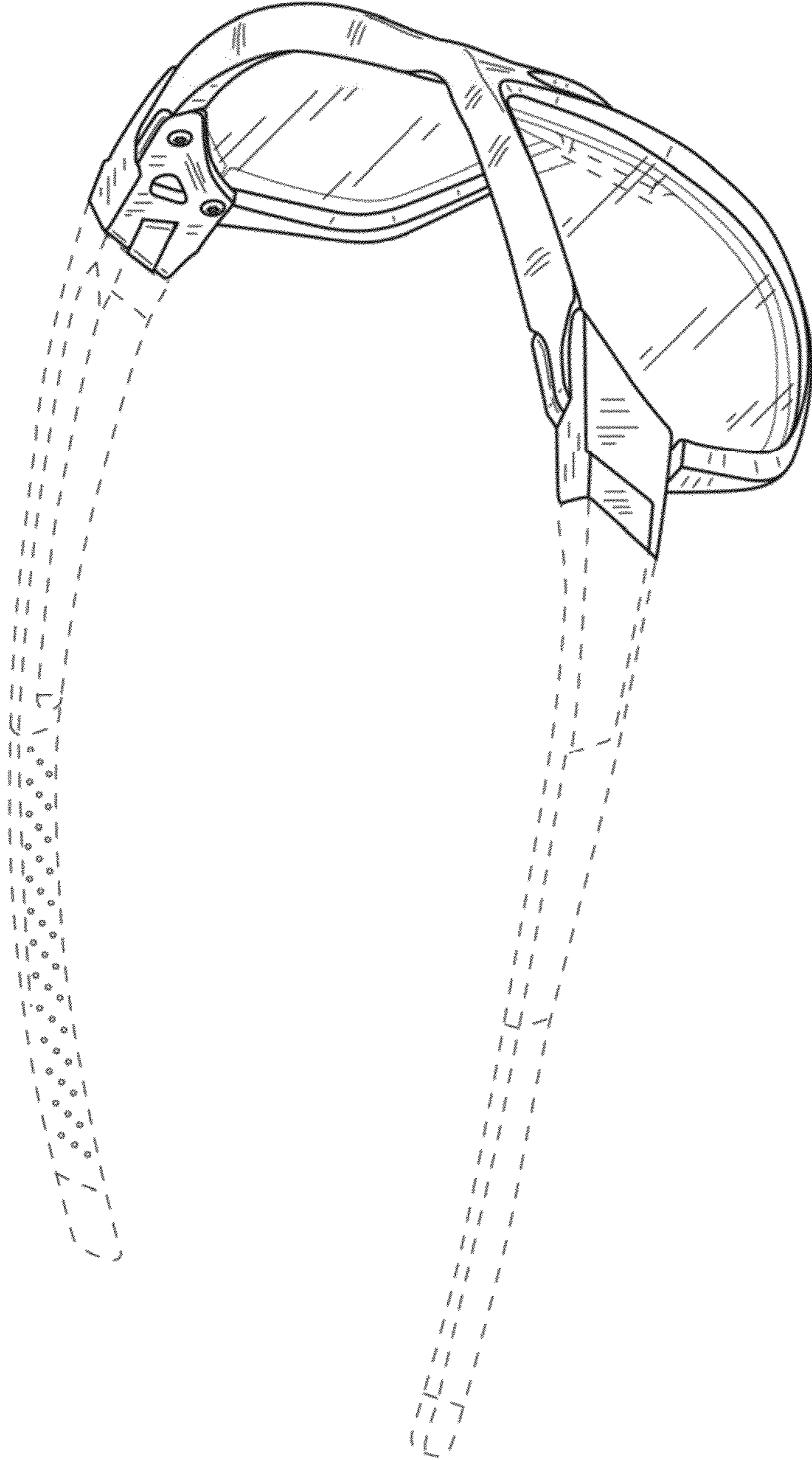

FIG.5

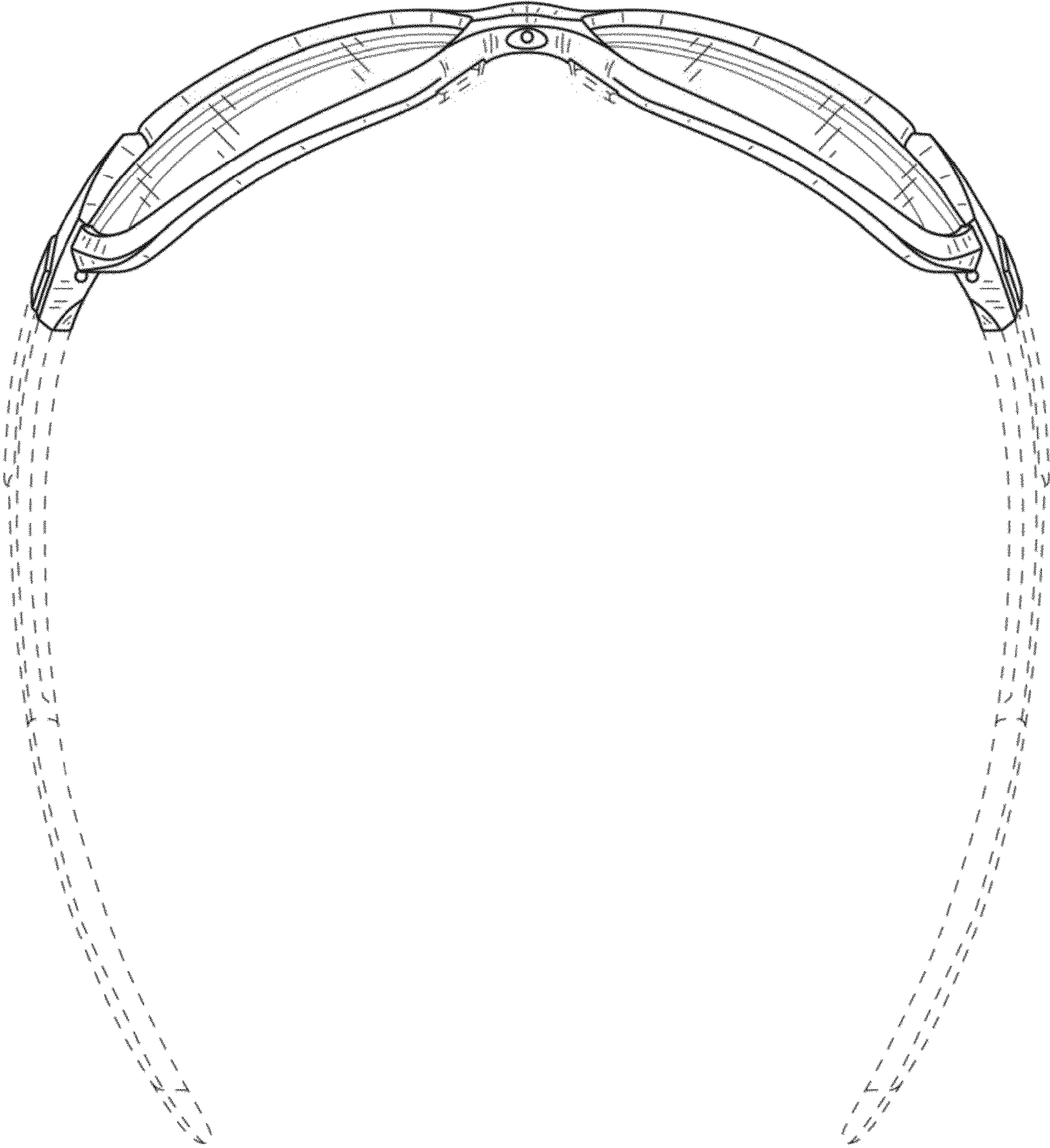

FIG.6

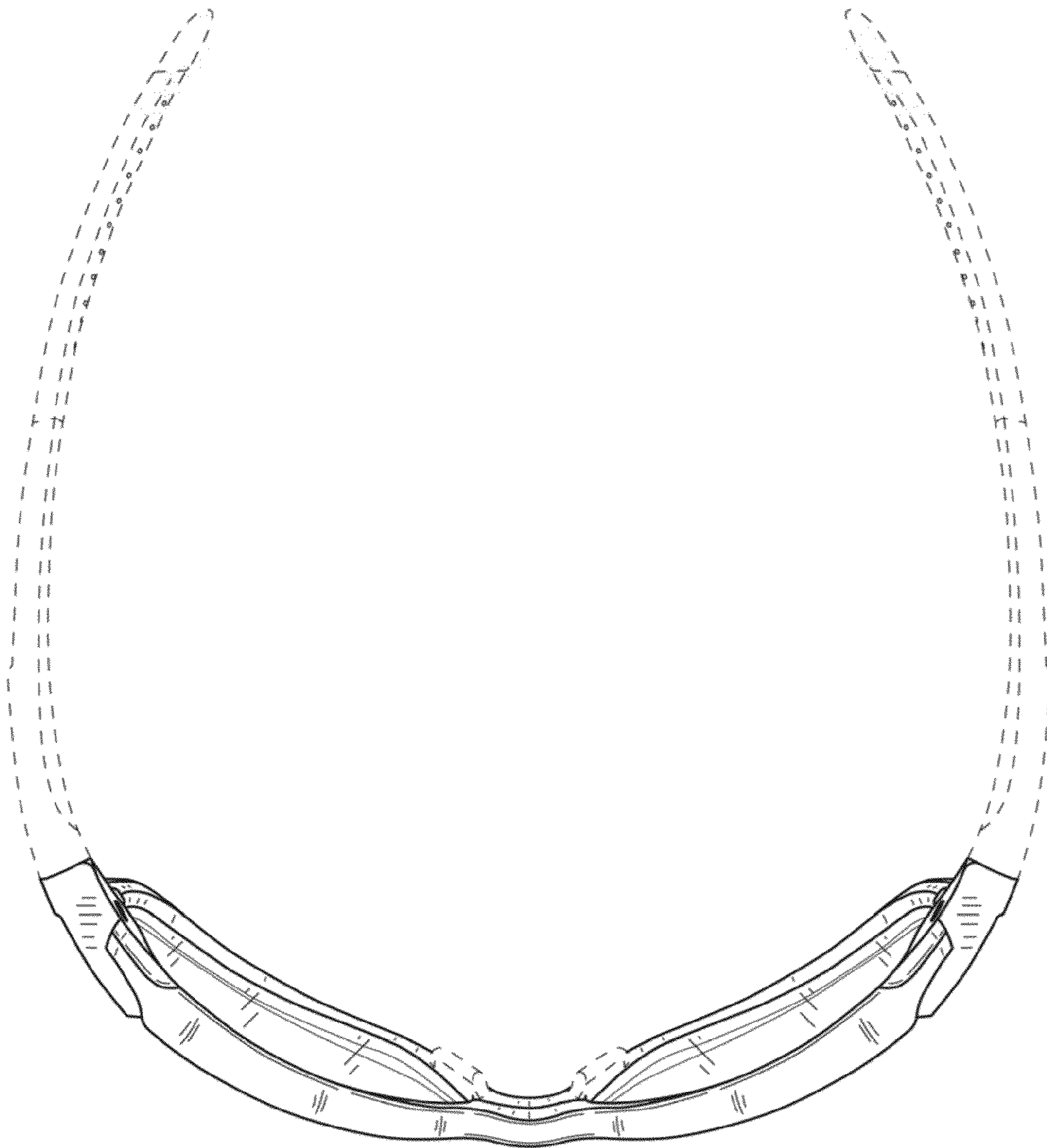

FIG.7

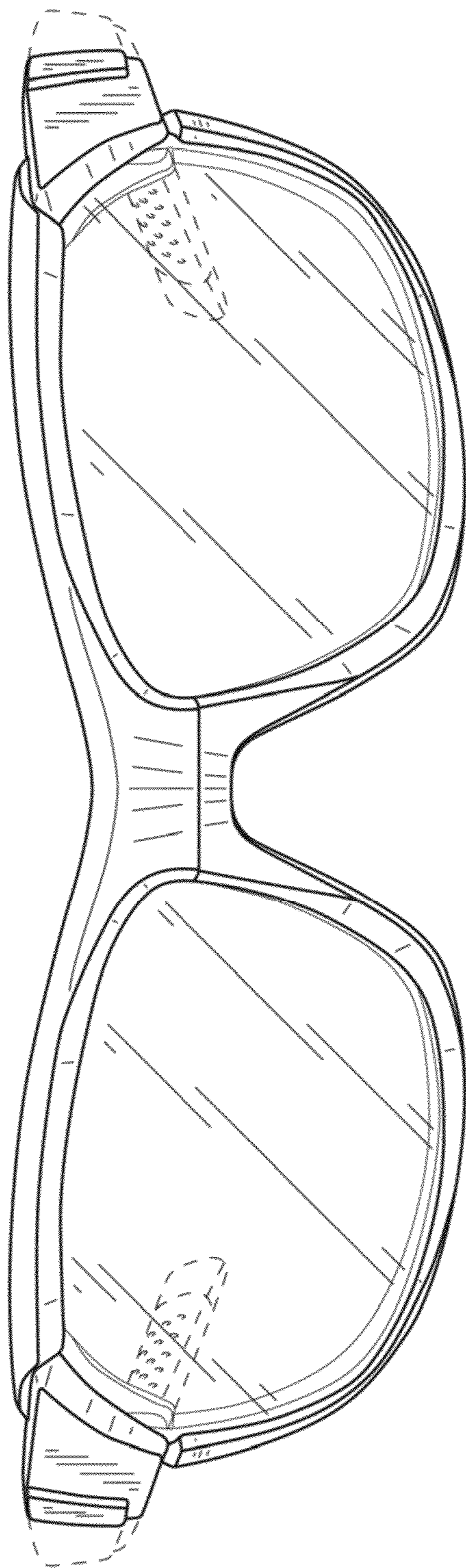

FIG.8