

US00D727257S

(12) **United States Design Patent**
Miller et al.

(10) **Patent No.:** **US D727,257 S**
(45) **Date of Patent:** **** Apr. 21, 2015**

- (54) **PORTABLE POWER CHARGER**
- (71) Applicants: **Garold C. Miller**, Glastonbury, CT (US); **Nathan Daniel Weinstein**, Glastonbury, CT (US)
- (72) Inventors: **Garold C. Miller**, Glastonbury, CT (US); **Nathan Daniel Weinstein**, Glastonbury, CT (US)
- (73) Assignee: **Halo2Cloud, LLC**, Glastonbury, CT (US)
- (**) Term: **14 Years**
- (21) Appl. No.: **29/478,783**
- (22) Filed: **Jan. 8, 2014**

Related U.S. Application Data

- (62) Division of application No. 29/440,522, filed on Dec. 21, 2012, now Pat. No. Des. 697,867.
- (51) **LOC (10) Cl.** **13-02**
- (52) **U.S. Cl.**
USPC **D13/108**; D13/103
- (58) **Field of Classification Search**
CPC Y02E 60/10; Y02E 60/12; Y02E 60/122; Y02E 60/124; Y02E 60/50; H01M 2/02; H01M 2/022; H01M 2/0202; H01M 2/0207; H01M 2/0212; H01M 2/1061; H01M 2/1022; H01M 2/1055; H01M 2/1066; H01M 2/105; H01M 2/20; H01M 2/202; H01M 2/204; H01M 2/206; H01M 10/4257; H01M 10/0436; H01M 10/48; H01M 10/44; H01M 10/46; H01M 10/465; H01M 10/482; H01M 10/488; H01M 10/24; H01M 2200/30; H01M 2250/30; H01M 2250/40; H02J 7/00; H02J 7/0003; H02J 7/0011; H02J 7/0013; H02J 7/02; H02J 7/04; H02J 7/0027; H02J 7/0054; H02J 7/0055; H02J 2007/0062
USPC D13/102-110, 118-119, 184, 199; D14/356, 432; 320/103, 111-115, 320/135-146

See application file for complete search history.

(56) **References Cited**

U.S. PATENT DOCUMENTS

D416,233 S 11/1999 Tsai
6,528,970 B1 3/2003 Liu et al.

(Continued)

Primary Examiner — Rosemary K Tarcza

(74) *Attorney, Agent, or Firm* — McCormick, Paulding & Huber LLP

(57) **CLAIM**

The ornamental design for a portable power charger, as shown and described.

DESCRIPTION

FIG. 1 is a front, top perspective view of a portable power charger comprising an embodiment of a new, original and ornamental design;

FIG. 2 is a top view of a portable power charger comprising an embodiment of the new, original and ornamental design, shown in an open position;

FIG. 3 is a bottom view of a portable power charger comprising an embodiment of the new, original and ornamental design;

FIG. 4 is a left-hand side view of a portable power charger comprising an embodiment of the new, original and ornamental design;

FIG. 5 is a right-hand side view of a portable power charger comprising an embodiment of the new, original and ornamental design;

FIG. 6 is another right-hand side view of a portable power charger comprising an embodiment of the new, original and ornamental design, shown in an open position;

FIG. 7 is a front view of a portable power charger comprising an embodiment of the new, original and ornamental design;

FIG. 8 is a rear view of a portable power charger comprising an embodiment of the new original and ornamental design; and,

FIG. 9 is another rear view of a portable power charger comprising an embodiment of the new original and ornamental design, shown in an open position.

The broken line portion of the figure drawings is included to show unclaimed subject matter only and forms no part of the claimed design.

1 Claim, 4 Drawing Sheets

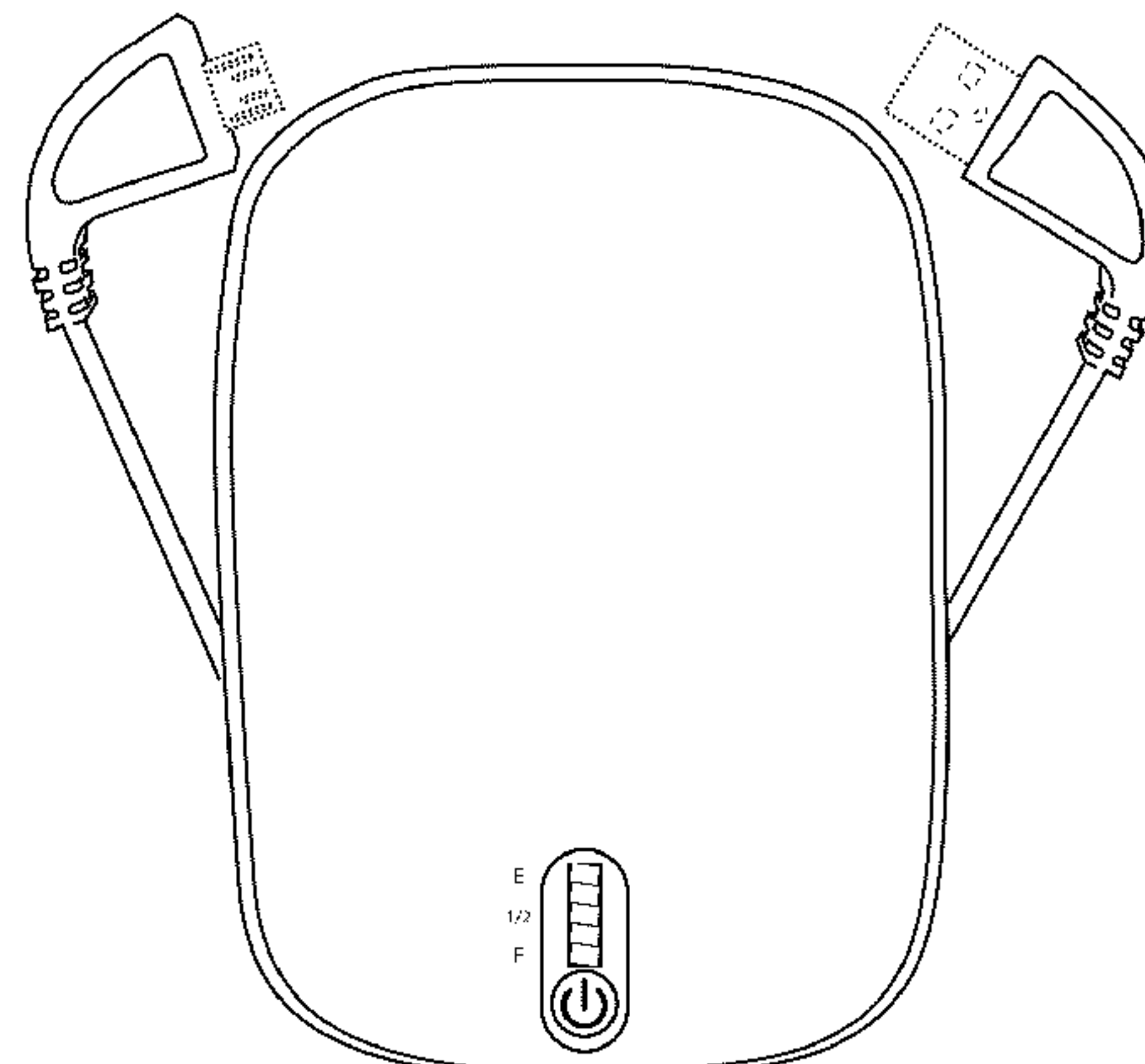

(56)

References Cited

U.S. PATENT DOCUMENTS

6,612,875 B1	9/2003	Liao	
6,894,457 B2	5/2005	Germagian et al.	
D592,138 S *	5/2009	Mahaffey et al.	D13/123
D618,237 S *	6/2010	Wang	D14/356
D628,535 S *	12/2010	Cheng	D13/108
D636,337 S	4/2011	Smith et al.	
D641,754 S	7/2011	Camarena et al.	
D642,514 S	8/2011	Van Den Donker et al.	
D643,427 S	8/2011	McGoldrick et al.	
D653,609 S	2/2012	Bende	
D656,091 S	3/2012	Van Den Donker et al.	
D656,096 S *	3/2012	Sasada et al.	D13/108
D659,094 S *	5/2012	Brand et al.	D13/108
D662,050 S *	6/2012	Tien	D13/108
D663,684 S *	7/2012	Yang	D13/108
D663,685 S *	7/2012	Yang	D13/108
D667,788 S *	9/2012	Mai	D13/110
D672,309 S *	12/2012	Tien	D13/108
D674,748 S *	1/2013	Ferber et al.	D13/108
D675,156 S *	1/2013	Vandiver et al.	D13/108
D680,063 S *	4/2013	Sasada	D13/103
D682,196 S *	5/2013	Leung	D13/103
D682,197 S *	5/2013	Leung	D13/103
D686,153 S *	7/2013	Qu	D13/103
D694,703 S	12/2013	Faro	
D697,867 S *	1/2014	Weinstein et al.	D13/108
D704,626 S	5/2014	Li	
D709,026 S	7/2014	Lee et al.	
D713,785 S *	9/2014	Tehrani	D13/108
2004/0085694 A1	5/2004	Germagian et al.	
2012/0238132 A1	9/2012	McSweyn	
2014/0042969 A1 *	2/2014	Miller et al.	320/111

* cited by examiner

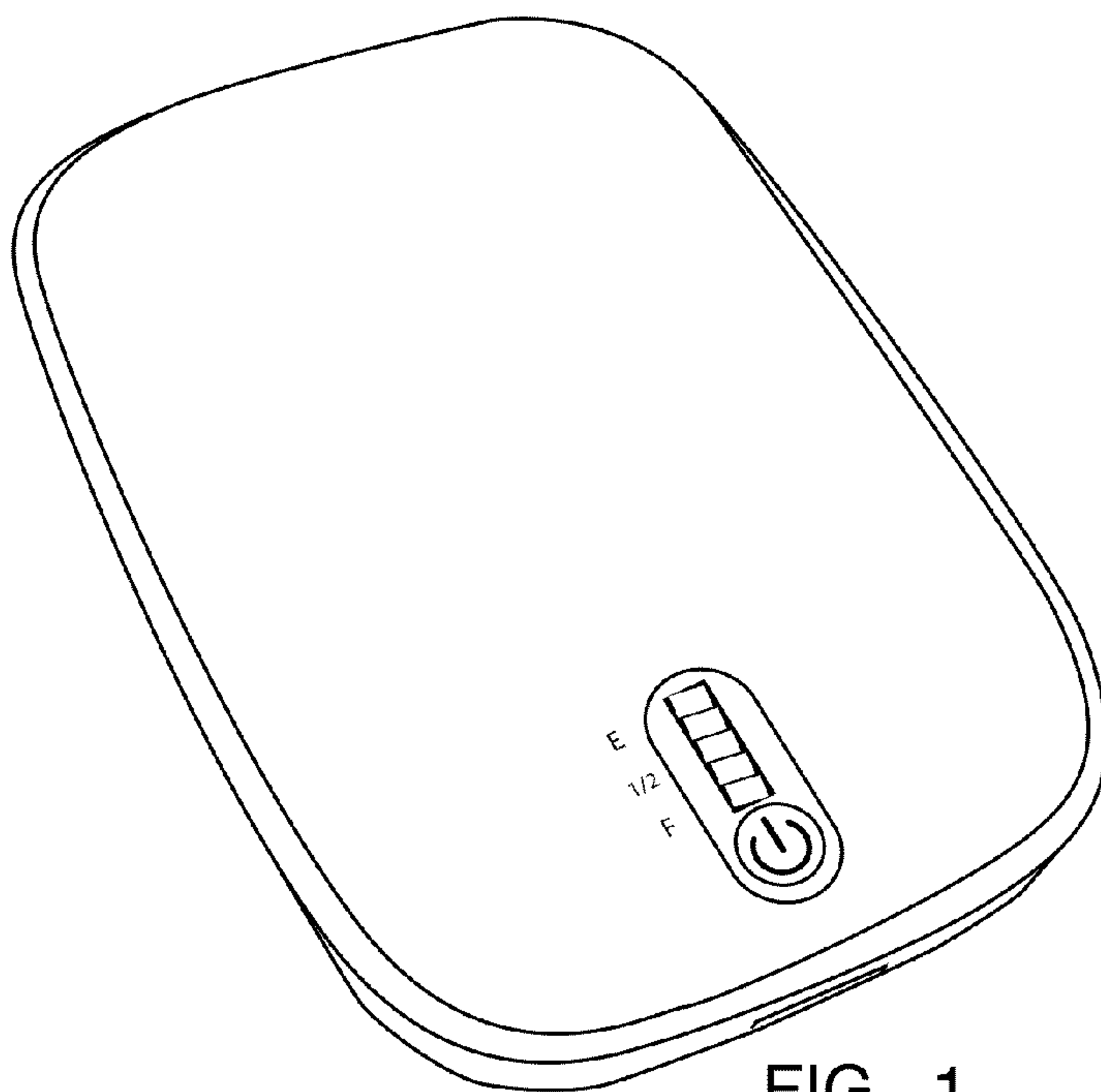

FIG. 1

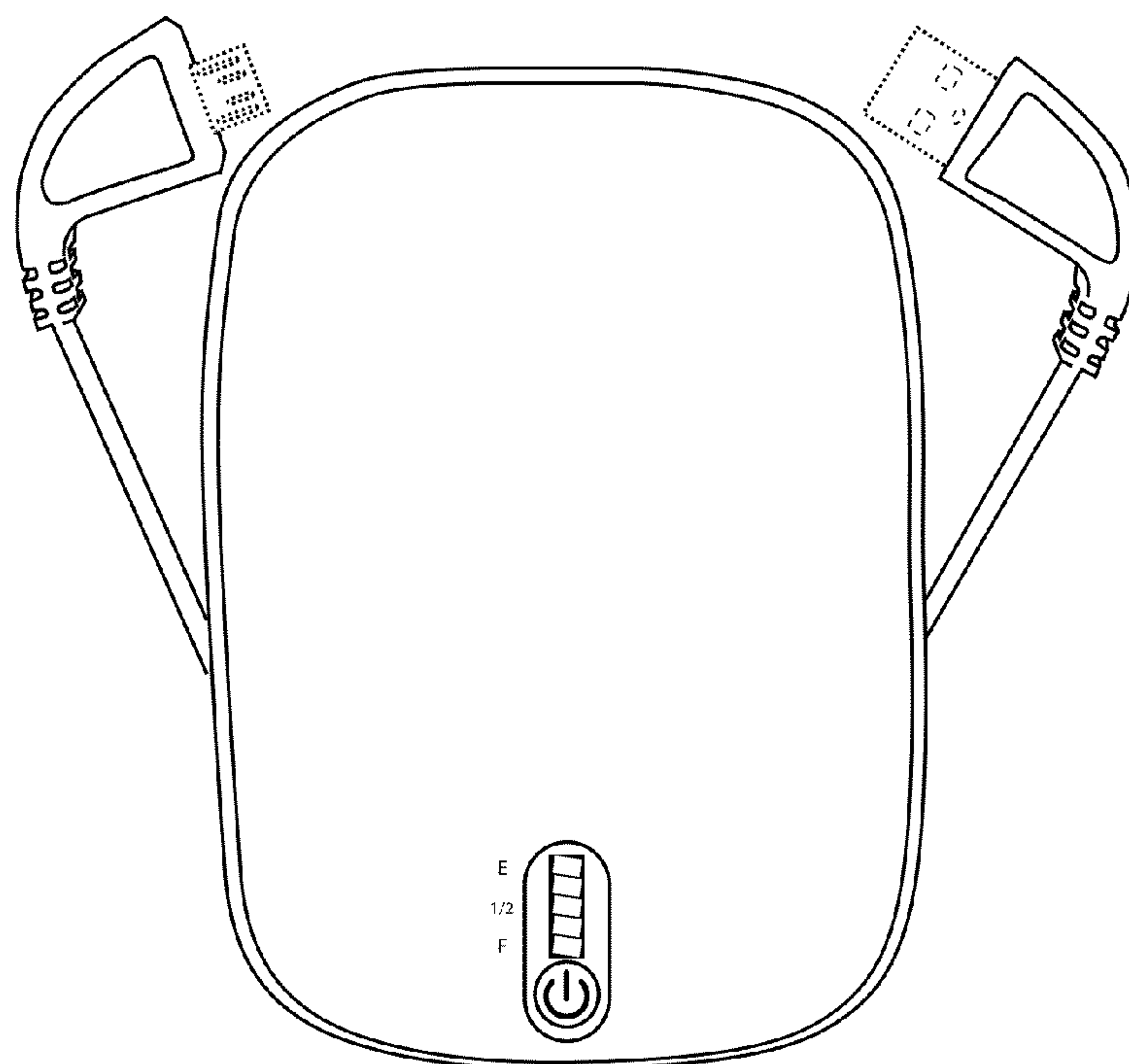

FIG. 2

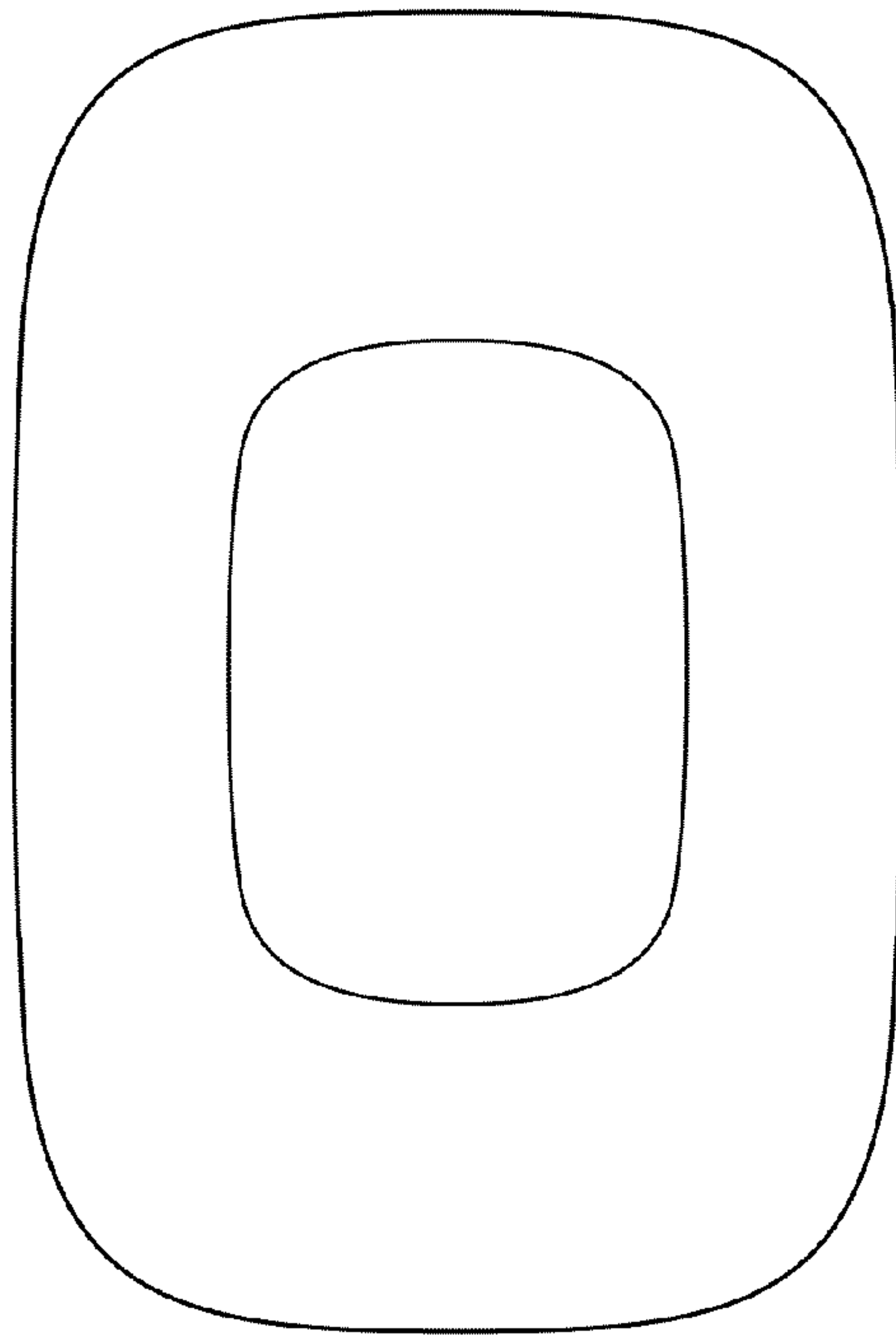

FIG. 3

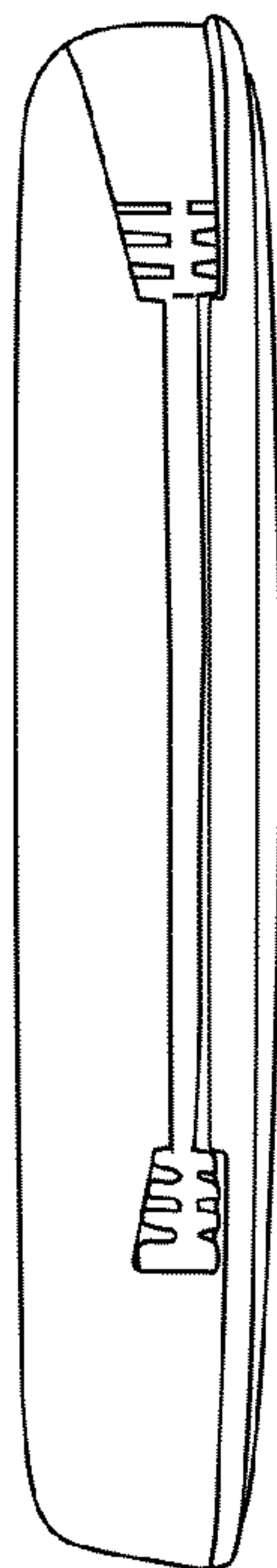

FIG. 4

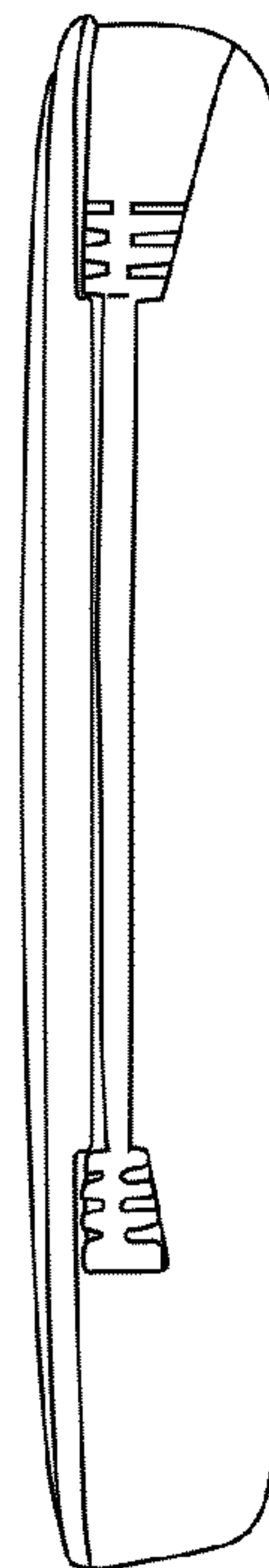

FIG. 5

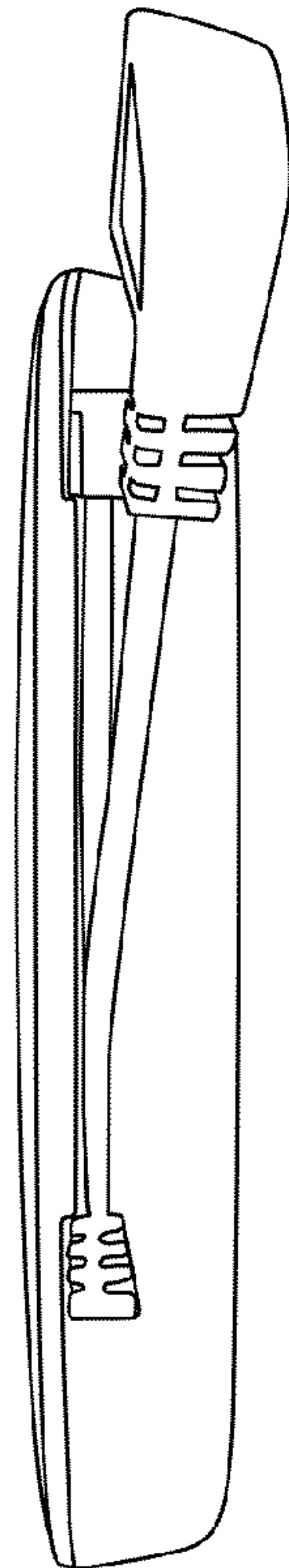

FIG. 6

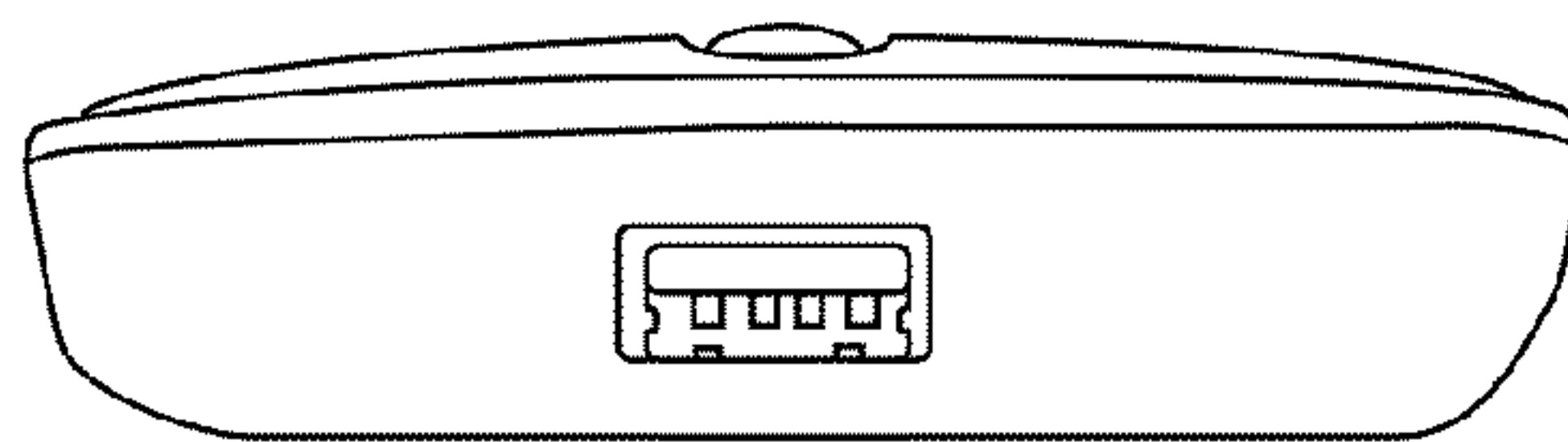

FIG. 7

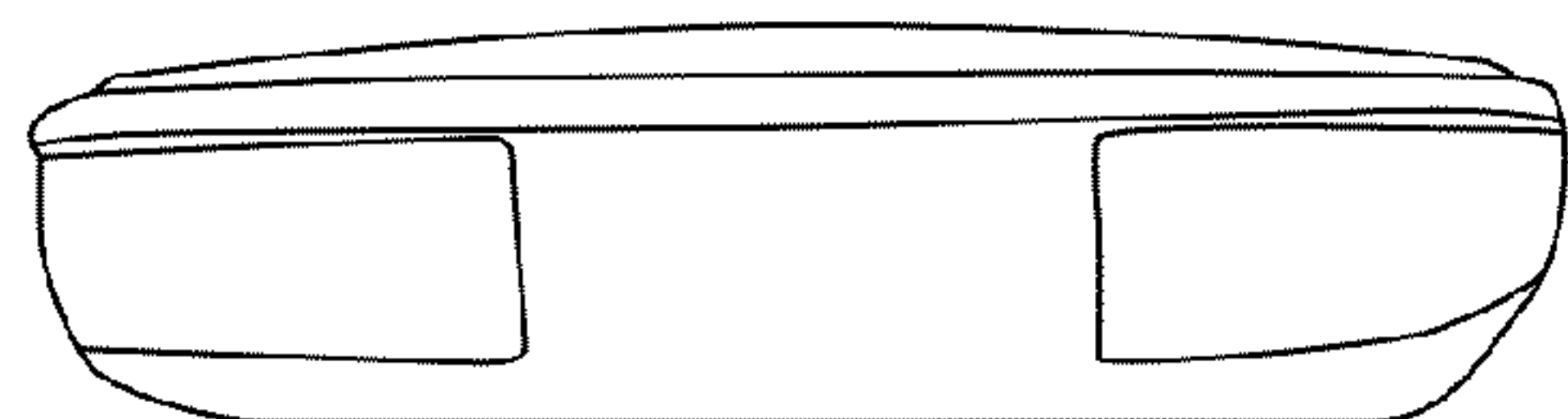

FIG. 8

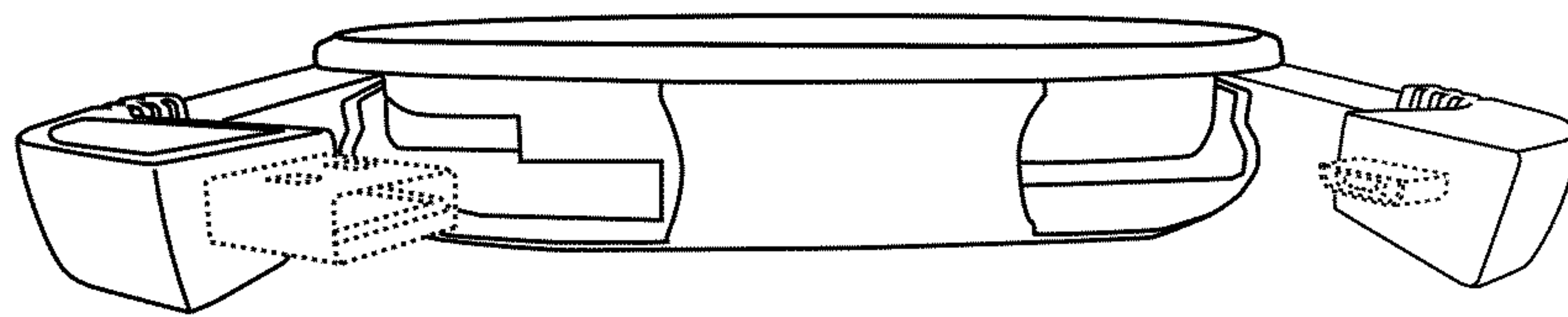

FIG. 9