



US00D727107S

(12) **United States Design Patent**
Parodi, Jr.

(10) **Patent No.:** **US D727,107 S**
(45) **Date of Patent:** **** Apr. 21, 2015**

- (54) **CLIP ON SHOT GLASS**
- (71) Applicant: **John Parodi, Jr.**, Costa Mesa, CA (US)
- (72) Inventor: **John Parodi, Jr.**, Costa Mesa, CA (US)
- (73) Assignee: **GetMugShot, Inc.**, Costa Mesa, CA (US)

- 1,798,339 A 10/1928 Soulis
- 1,692,951 A 11/1928 Pinckney
- 1,762,331 A 6/1930 Greist
- 1,772,176 A 8/1930 Benjamin
- 1,948,932 A 2/1934 McMickle
- 2,278,401 A 3/1942 Micari
- 2,314,835 A 3/1943 Johns
- D139,569 S 11/1944 O'Brien

(Continued)

(**) Term: **14 Years**

FOREIGN PATENT DOCUMENTS

(21) Appl. No.: **29/483,424**

WO 2011006976 1/2011

(22) Filed: **Feb. 28, 2014**

OTHER PUBLICATIONS

(51) **LOC (10) Cl.** **07-01**

Barconic 2 oz Assorted Plastic Shot Glass with Hook, BarSupplies.com, 2014, retrieved from <http://barsupplies.com/barconic-2oz-assorted-plastic-shot-glass-with-hook-p-16065.html>, 6 pages.

(52) **U.S. Cl.**

USPC **D7/533; D7/515; D7/543; D7/396.2**

(Continued)

(58) **Field of Classification Search**

USPC D7/502, 503, 505, 506, 507, 508, 509, D7/512, 514, 515, 517, 523, 528, 529, 531, D7/532, 549, 550, 550.1, 551.2, 551.3, D7/552.1, 553.1, 553.2, 553.3, 553.4, D7/553.5, 553.6, 553.7, 553.8, 554.2, 555, D7/558, 560, 579, 566, 578, 587, 588, D7/300.1, 300, 589, 705, 708.1, 620, 621, D7/633, 326, 667, 668, 396.2, 396.3, 409, D7/213, 533, 543; D9/445, 635, 667, 678, D9/444, 516, 529, 775, 776, 778, 555, 549, D9/519; 215/387, 228; 220/592, 592.16, 220/592.17, 703, 705, 709; D11/143, 144, D11/145, 146, 152, 153, 164; D32/54, 55, D32/59; D6/556, 557, 559, 562, 573, 574; D3/229

Primary Examiner — Marianne Pandozzi

Assistant Examiner — Jae Liang

(74) *Attorney, Agent, or Firm* — Brian S. Steinberger; Law Offices of Brian S. Steinberger, P.A.

See application file for complete search history.

(57) **CLAIM**

The ornamental design for a clip on shot glass, as shown and described.

(56) **References Cited**

U.S. PATENT DOCUMENTS

- 256,231 A 4/1882 Mackey
- D33,218 S 9/1900 Dixon
- 757,645 A 4/1904 Bassett
- 1,499,452 A 7/1924 Gay

DESCRIPTION

FIG. 1 is a top front perspective view of a clip on shot glass showing my new design;
FIG. 2 is a bottom rear perspective view thereof;
FIG. 3 is a front view thereof;
FIG. 4 is a rear view thereof;
FIG. 5 is a right side view thereof;
FIG. 6 is a left side view thereof;
FIG. 7 is a top view thereof; and,
FIG. 8 is a bottom view thereof.

1 Claim, 4 Drawing Sheets

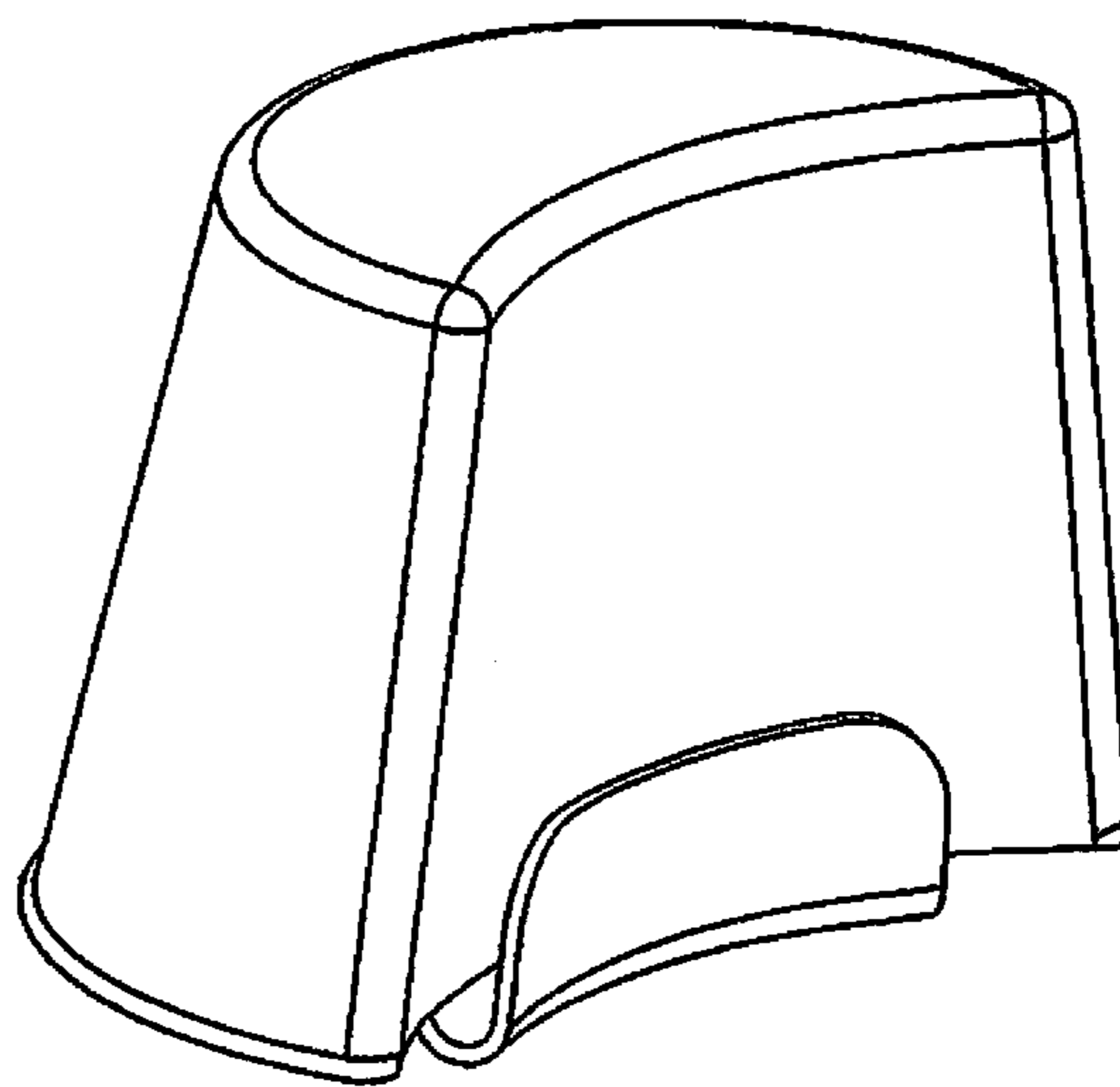
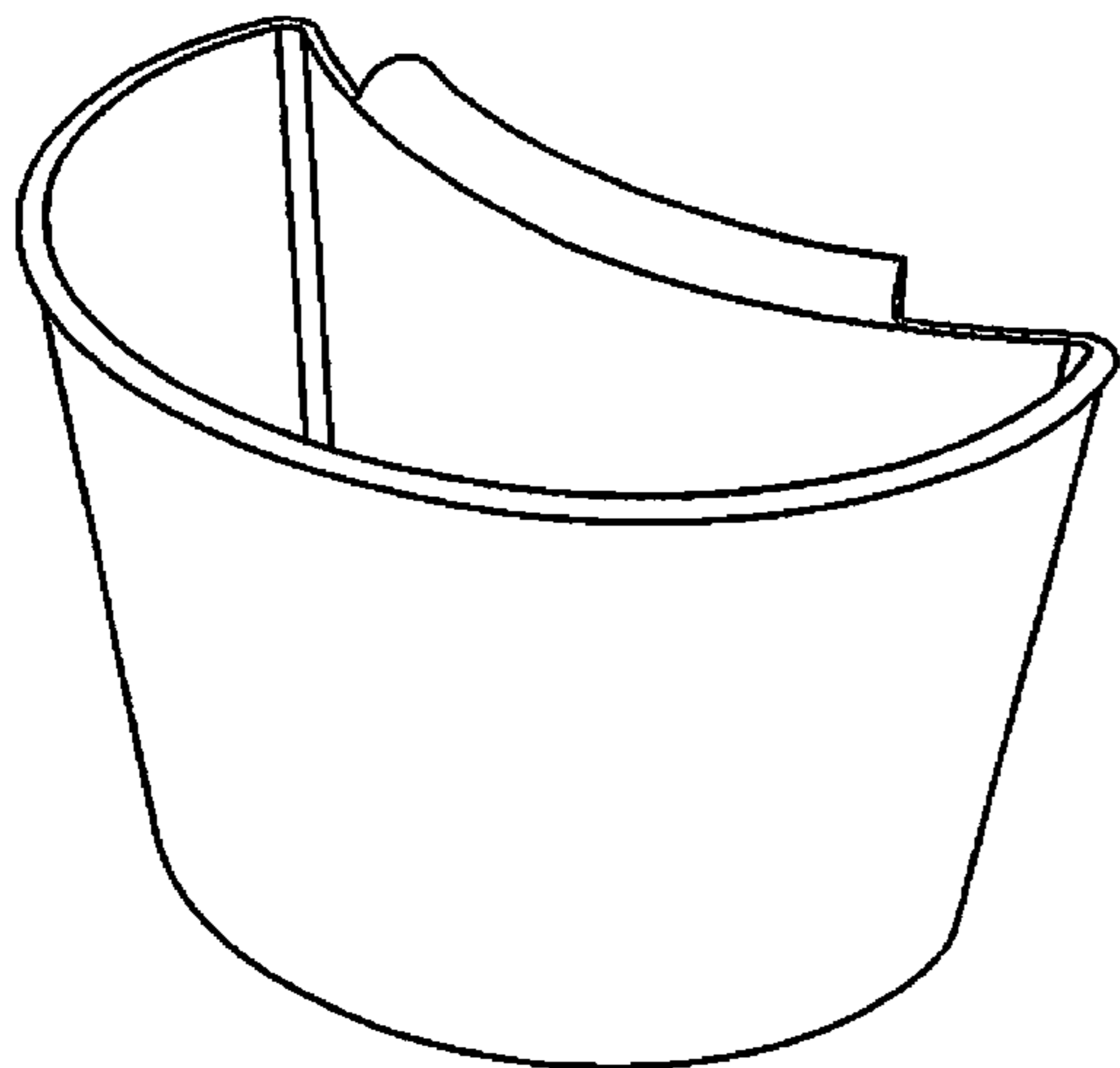

(56)

References Cited

U.S. PATENT DOCUMENTS

- D154,671 S * 8/1949 Foley D7/566
 2,613,517 A 10/1952 Frantz
 2,646,200 A 7/1953 Atkins
 2,680,557 A 6/1954 Madden
 2,740,576 A 4/1956 Franck
 2,787,408 A 4/1957 Andre
 2,856,113 A 10/1958 Brumby
 3,073,061 A * 1/1963 Pearson 47/83
 3,219,226 A 11/1965 Schroeder
 3,442,435 A * 5/1969 Huston et al. 220/528
 3,630,430 A 12/1971 Struble
 3,754,502 A 8/1973 Kaufman
 3,850,398 A 11/1974 Kantor
 D250,009 S * 10/1978 Karotseris D11/143
 4,183,444 A * 1/1980 English et al. 220/200
 4,410,129 A 10/1983 Wischusen
 4,436,217 A 3/1984 Ritter
 4,535,921 A 8/1985 Sanders
 D290,919 S 7/1987 Beute
 D302,050 S 7/1989 Ingrisani
 4,854,466 A 8/1989 Lane, Jr.
 4,989,742 A 2/1991 Powell
 D327,148 S * 6/1992 Alessi D32/54
 5,137,210 A 8/1992 Hibbs
 5,184,750 A 2/1993 Moller
 5,207,348 A * 5/1993 Fischer et al. 220/697
 D339,720 S * 9/1993 Kolada D7/667
 D341,686 S * 11/1993 Panovic D32/54
 5,261,577 A 11/1993 Goldstein
 5,279,007 A * 1/1994 Kolada 4/639
 5,297,695 A 3/1994 Provence
 D346,054 S * 4/1994 Spangler D32/54
 D347,354 S * 5/1994 Naft D7/354
 5,335,787 A 8/1994 Finchum
 5,375,742 A 12/1994 Mowry
 D358,914 S * 5/1995 Masse et al. D32/54
 5,429,262 A 7/1995 Sharkey
 D371,089 S * 6/1996 Yeung D11/152
 5,651,523 A 7/1997 Bridges
 D385,462 S 10/1997 Ferris
 D386,113 S * 11/1997 Sanderson D11/152
 5,687,873 A 11/1997 Jones
 D386,885 S * 12/1997 Bell D1/116
 D389,700 S 1/1998 Bingham
 5,775,570 A * 7/1998 Kim 229/4.5
 D404,241 S 1/1999 Bagley
 D405,574 S 2/1999 Riky
 5,924,615 A 7/1999 McGarrah
 5,931,431 A 8/1999 Stinnett
 D419,808 S * 2/2000 Hampshire D6/553
 6,068,181 A 5/2000 Cai
 6,076,700 A 6/2000 Manges
 D430,458 S * 9/2000 Kellermann D7/566
 6,152,362 A 11/2000 Rosenfeld
 6,193,201 B1 2/2001 Babcock
 D444,278 S 6/2001 Myers, Jr.
 6,264,026 B1 7/2001 Bradley
 6,308,859 B1 10/2001 Johnson
 6,321,929 B1 11/2001 Weshler
 6,372,270 B1 4/2002 Denny
 6,394,297 B1 5/2002 Nance
 D458,723 S * 6/2002 Malvasio D32/53.1
 D466,407 S * 12/2002 Nance D9/424
 D470,267 S 2/2003 Groendyke
 6,533,232 B1 3/2003 Aggeler
 D472,465 S * 4/2003 Nance D9/424
 6,601,813 B1 8/2003 Kager
 6,606,996 B1 8/2003 Thornell
 D484,363 S 12/2003 de Groote
 6,672,817 B2 1/2004 Denny
 6,783,021 B2 8/2004 Kaura
 D500,703 S * 1/2005 Giampavolo D11/146
 7,021,825 B1 4/2006 Schultz
 D531,054 S 10/2006 Sagel
 D531,858 S * 11/2006 Johnson D7/620
 D537,679 S * 3/2007 Majka D7/566
 D541,591 S * 5/2007 Wasserman et al. D7/584
 D543,074 S 5/2007 Luft
 D547,174 S * 7/2007 Fireman D9/423
 D557,413 S 12/2007 Buermann
 D562,639 S * 2/2008 Ablo D7/566
 D573,412 S 7/2008 Ablo
 D577,615 S 9/2008 Markfelder
 7,441,675 B2 * 10/2008 McGinley et al. 222/129
 D586,969 S 2/2009 Graham
 D596,900 S * 7/2009 Kluger D7/509
 D600,741 S * 9/2009 Sued et al. D18/34.9
 D600,980 S * 9/2009 Regan et al. D7/605
 D607,275 S * 1/2010 Griffith D7/505
 D610,408 S 2/2010 Paolini
 D623,019 S 9/2010 Wildman
 D625,956 S * 10/2010 Goddard-Clark et al. D7/543
 D625,961 S 10/2010 Kent
 7,874,449 B1 1/2011 Studee
 D641,653 S * 7/2011 Gregson et al. D11/143
 7,980,406 B2 7/2011 Liu
 D643,248 S 8/2011 Schmidt
 D645,355 S * 9/2011 D'Amato D9/522
 8,061,545 B2 11/2011 Roth
 D651,469 S * 1/2012 Myoung et al. D7/543
 D653,085 S 1/2012 Swallow
 D665,232 S 8/2012 O'Connell
 D674,595 S * 1/2013 Alexander D3/229
 8,348,091 B1 * 1/2013 Zox 220/694
 8,443,996 B2 5/2013 Ciarrocchi
 D684,429 S 6/2013 Lion
 D691,390 S * 10/2013 Cunningham et al. D6/556
 D691,426 S 10/2013 Brown
 D694,905 S 12/2013 Brown
 D710,701 S * 8/2014 Lai D9/456
 D713,207 S 9/2014 Hickox
 8,827,104 B2 9/2014 Hickox
 2002/0134781 A1 9/2002 Ciarrocchi
 2003/0019871 A1 1/2003 Nance
 2004/0031796 A1 2/2004 Krueger
 2006/0086756 A1 4/2006 Roth
 2007/0095843 A1 5/2007 Wu
 2007/0205199 A1 9/2007 Wothers
 2008/0035655 A1 2/2008 Baumgartner
 2008/0312556 A1 * 12/2008 Dijkman 600/584
 2009/0090710 A1 4/2009 Nielsen
 2009/0108004 A1 4/2009 Bollengier
 2011/0084087 A1 4/2011 Scribner
 2011/0272546 A1 11/2011 Nielsen
 2012/0097576 A1 4/2012 Dold
 2012/0199597 A1 8/2012 Myoung
 2012/0273509 A1 11/2012 Yao
 2012/0285952 A1 11/2012 James
 2013/0277375 A1 10/2013 Hickox
 2014/0346102 A1 * 11/2014 Housley 210/232

OTHER PUBLICATIONS

- Nutty by Nature: Vita Coco works to make coconut water the next orange juice, Beverage Industry, 2014, bevindustry.com, pp. 68-69.
 Party Cup Sidecar, Party Sidecar Shotglass, RP & Associates, Inc., 2014, <http://www.rpandassociates.com/drinkware/party-cup-sidecar>, 2 pages.
 The Hitch, Get Hitched, RP & Associates, Inc., 2014, <http://www.rpandassociates.com/drinkware/the-hitch>, 2 pages.
 Beverage Industry Magazine features The Hitch, A new kind of sidecar, RP & Associates, Inc., 2014, <http://www.rpandassociates.com/custom-drinkware/beverage-industry-magazine-features-t...>, 2 pages.
 Press Release: RP & Associates Unveils The Hitch, a Unique Way to Serve Shots & Gain Brand Recognition, RP & Associates, Inc., 2014, <http://www.rpandassociates.com/custom-drinkware/press-release-rp-associates-unveils-the...>, 2 pages.

* cited by examiner

FIG.1

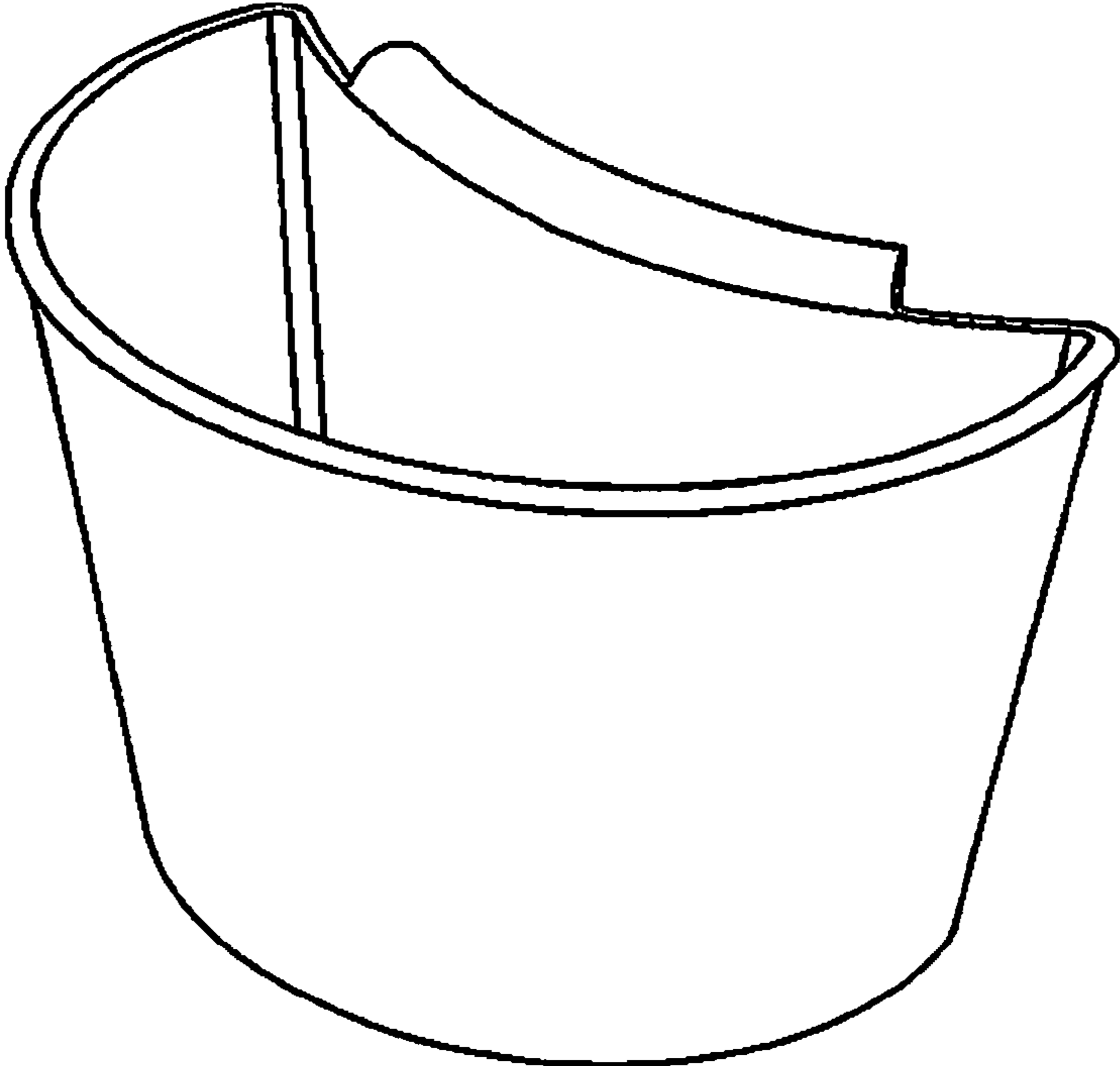

FIG.2

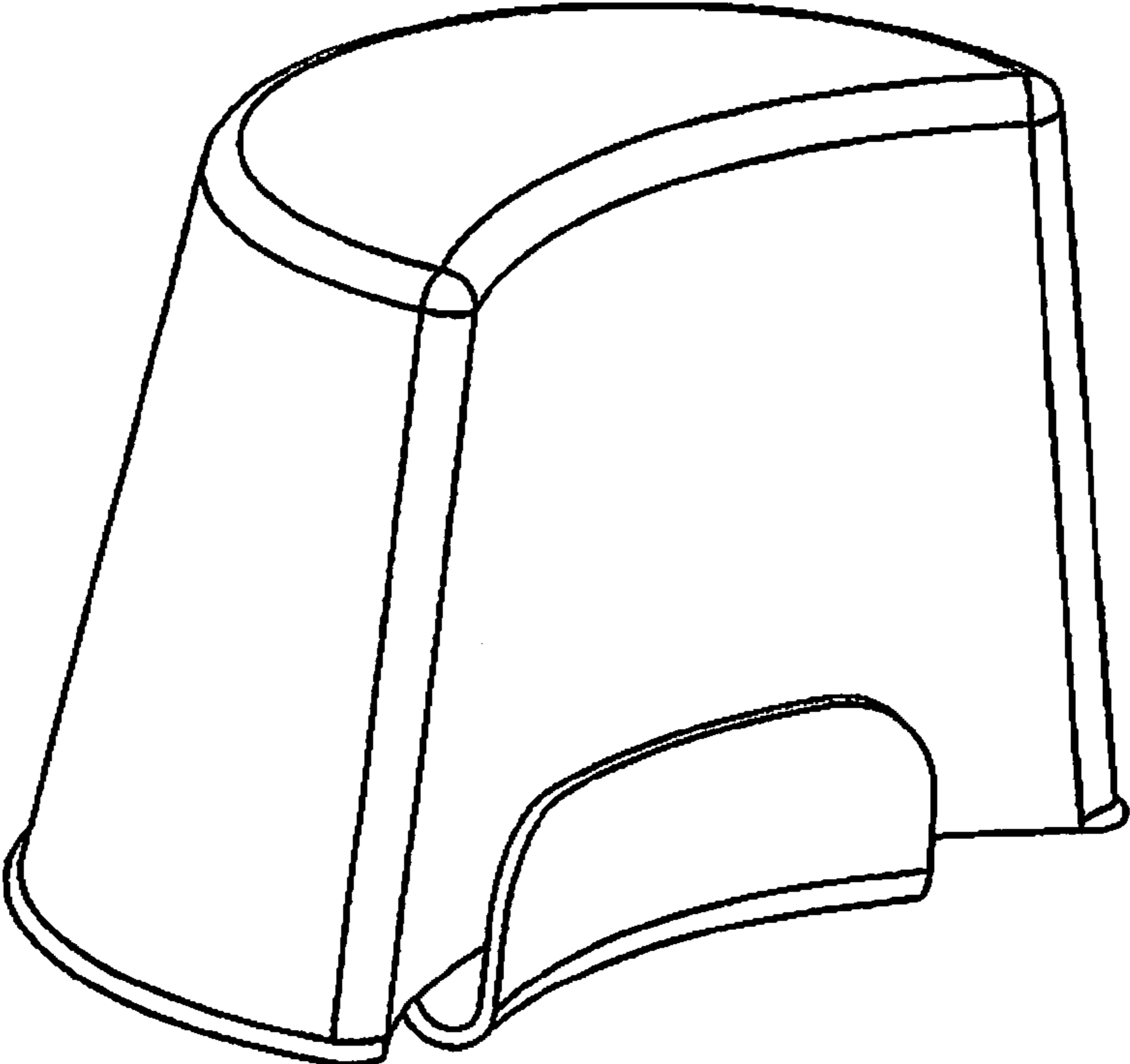

FIG. 3

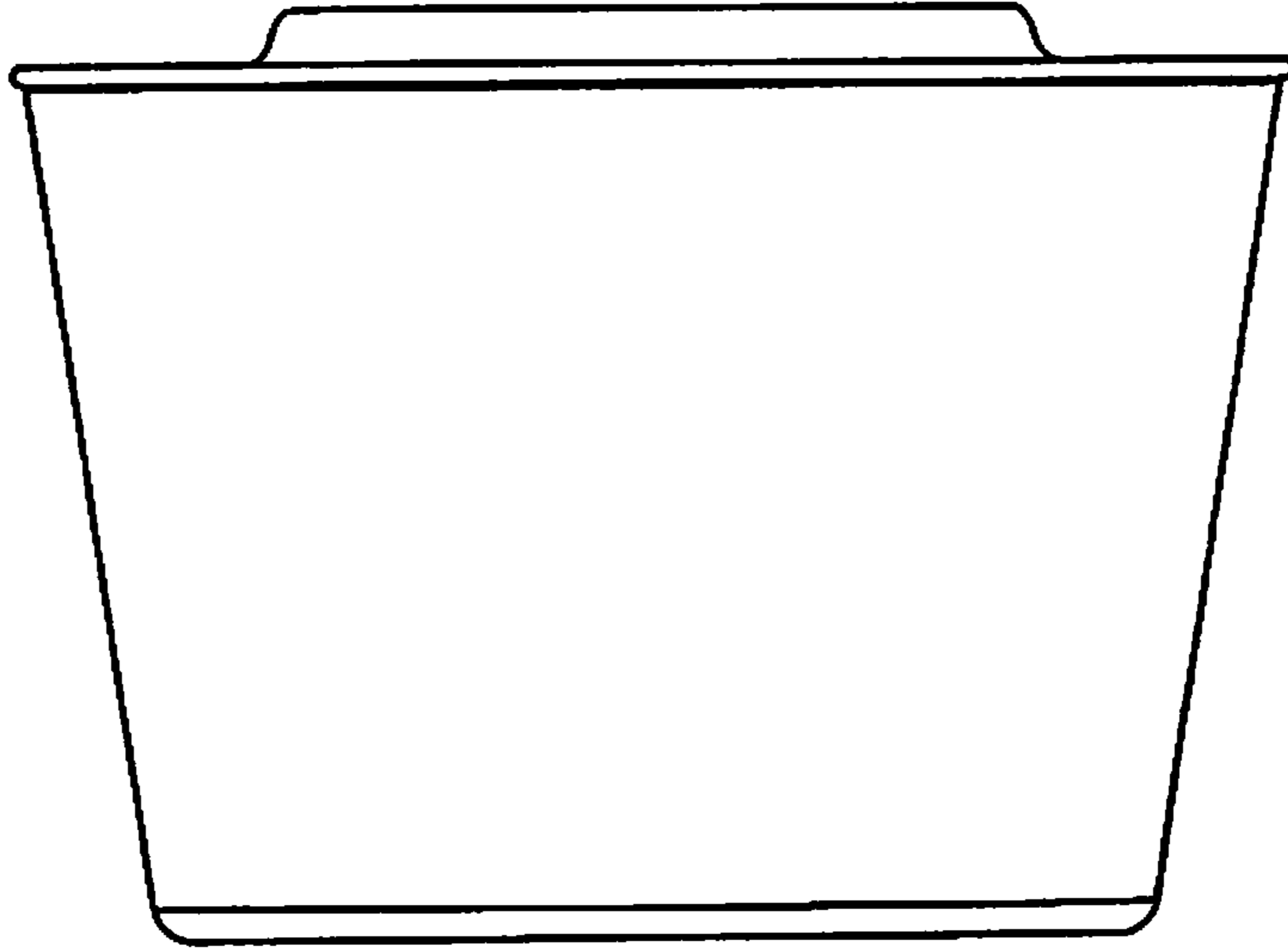

FIG. 4

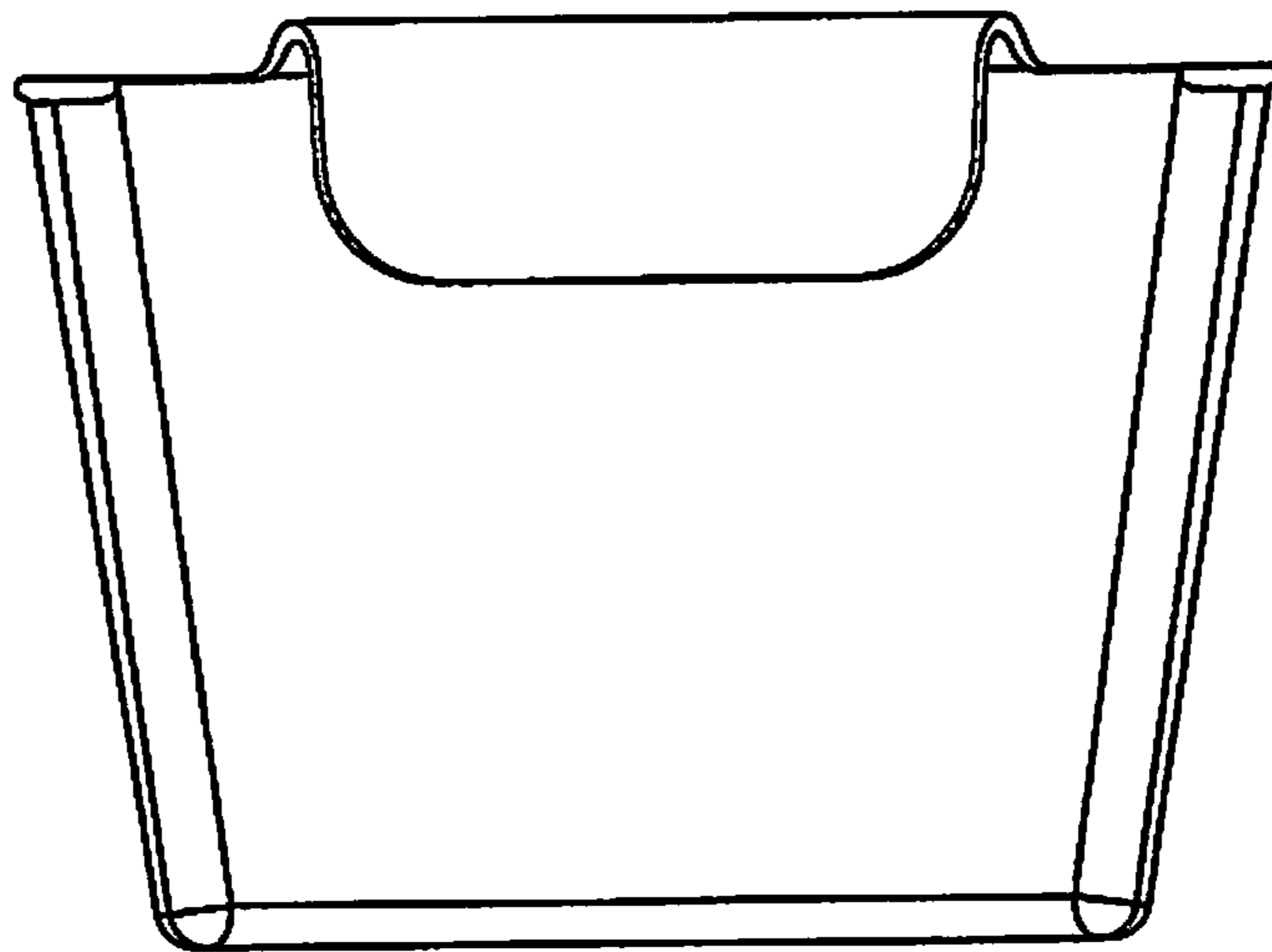

FIG. 5

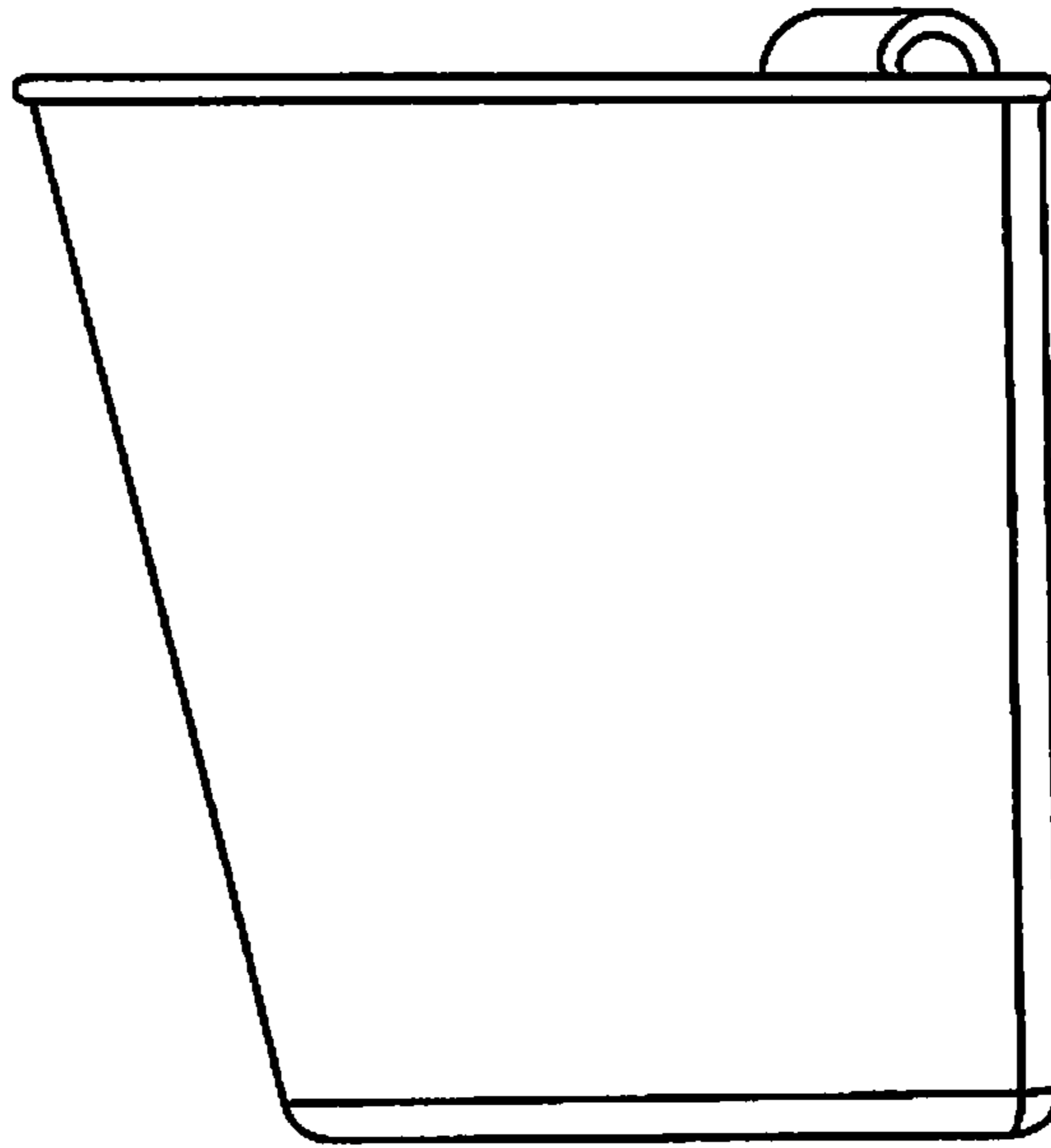

FIG. 6

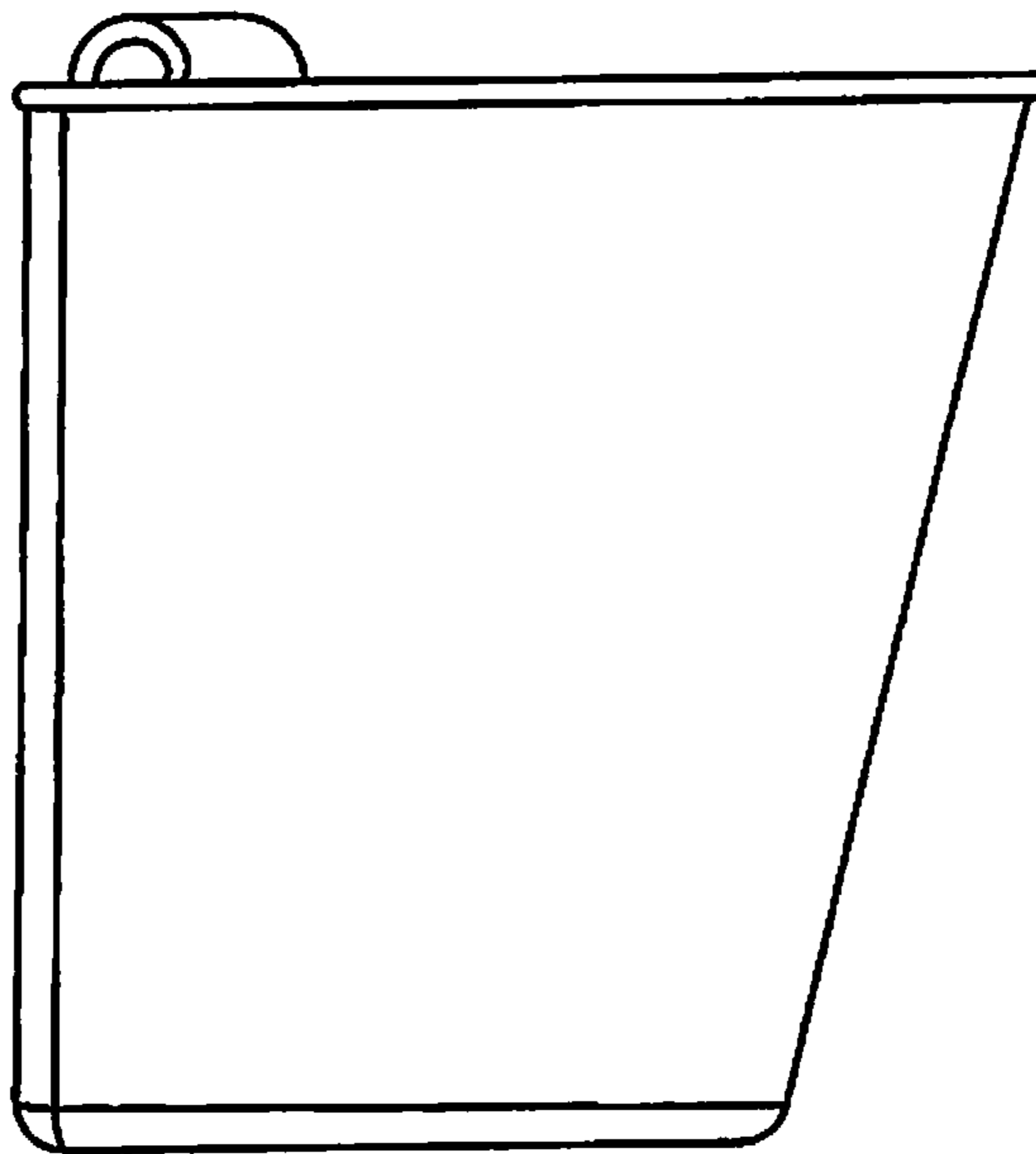

FIG. 7

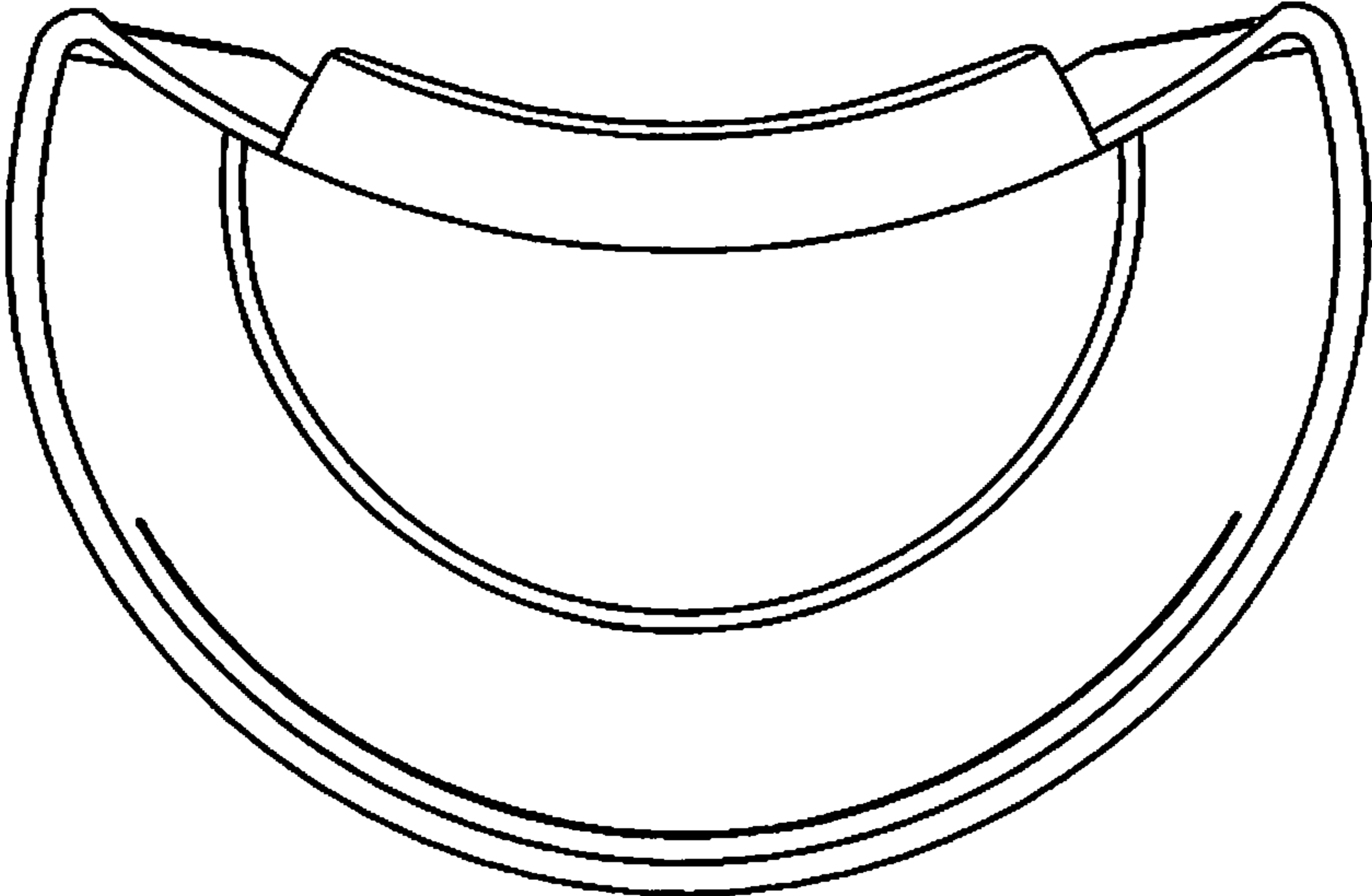

FIG. 8

