

US00D727059S

(12) **United States Design Patent**  
**Williams**

(10) **Patent No.:** **US D727,059 S**

(45) **Date of Patent:** **\*\* Apr. 21, 2015**

(54) **TRAY WITH LID**

(57) **CLAIM**

The ornamental design for a tray with lid, as shown and described.

(71) Applicant: **Billy L. Williams**, Boca Raton, FL (US)

**DESCRIPTION**

(72) Inventor: **Billy L. Williams**, Boca Raton, FL (US)

(\*\*) Term: **14 Years**

FIG. 1 is a top, front, and right side perspective view of a tray with lid showing my new design;

FIG. 2 is an exploded top, front, and right side perspective view thereof;

FIG. 3 is a bottom, front, and right side perspective view of the tray portion there, the lid being omitted for clarity of illustration;

FIG. 4 is a top plan view of the lid portion thereof, the tray portion being omitted for clarity of illustration;

FIG. 5 is a top plan view of the tray portion thereof, the lid portion being omitted for clarity of illustration;

FIG. 6 is a bottom plan of the lid portion thereof, the tray portion being omitted for clarity of illustration;

FIG. 7 is a bottom plan view of the tray portion thereof, the lid portion being omitted for clarity of illustration;

FIG. 8 is a rear elevational view of the lid portion thereof, the tray portion being omitted for clarity of illustration;

FIG. 9 is a rear elevational view of the tray portion thereof, the lid portion being omitted for clarity of illustration;

FIG. 10 is a front elevational view of the lid portion thereof, the tray portion being omitted for clarity of illustration;

FIG. 11 is a front elevational view of the tray portion thereof, the lid portion being omitted for clarity of illustration;

FIG. 12 is a right side elevational view of the lid portion thereof, the tray portion being omitted for clarity of illustration;

FIG. 13 is a right side elevational view of the tray portion thereof, the lid portion being omitted for clarity of illustration;

FIG. 14 is a left side elevational view of the lid portion thereof, the tray portion being omitted for clarity of illustration; and,

FIG. 15 is a left side elevational view of the tray portion thereof, the lid portion being omitted for clarity of illustration.

(21) Appl. No.: **29/463,323**

(22) Filed: **Oct. 15, 2013**

(51) **LOC (10) Cl.** ..... **23-02**

(52) **U.S. Cl.**

USPC ..... **D6/525**

(58) **Field of Classification Search**

USPC ..... D6/524, 525; D7/500, 505, 555, 601, D7/701, 637; D11/131, 143, 146, 152; D28/73; 47/41.1, 65.5, 66.1, 66.6, 47/66.7, 69; 211/13.1, 69.1, 62, 70.6, 211/70.7, 119.011; D3/308, 315, 313

See application file for complete search history.

(56) **References Cited**

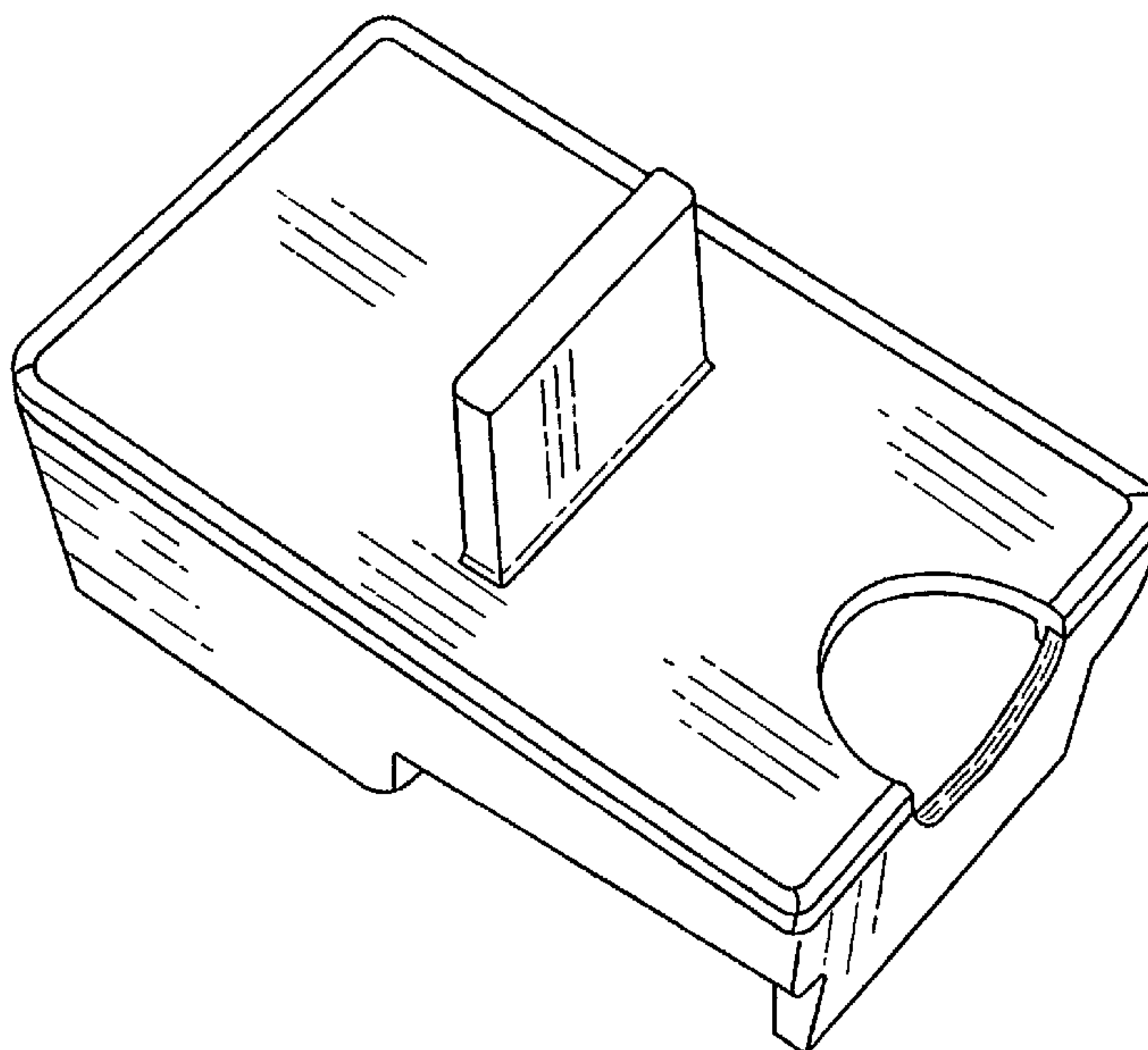
**U.S. PATENT DOCUMENTS**

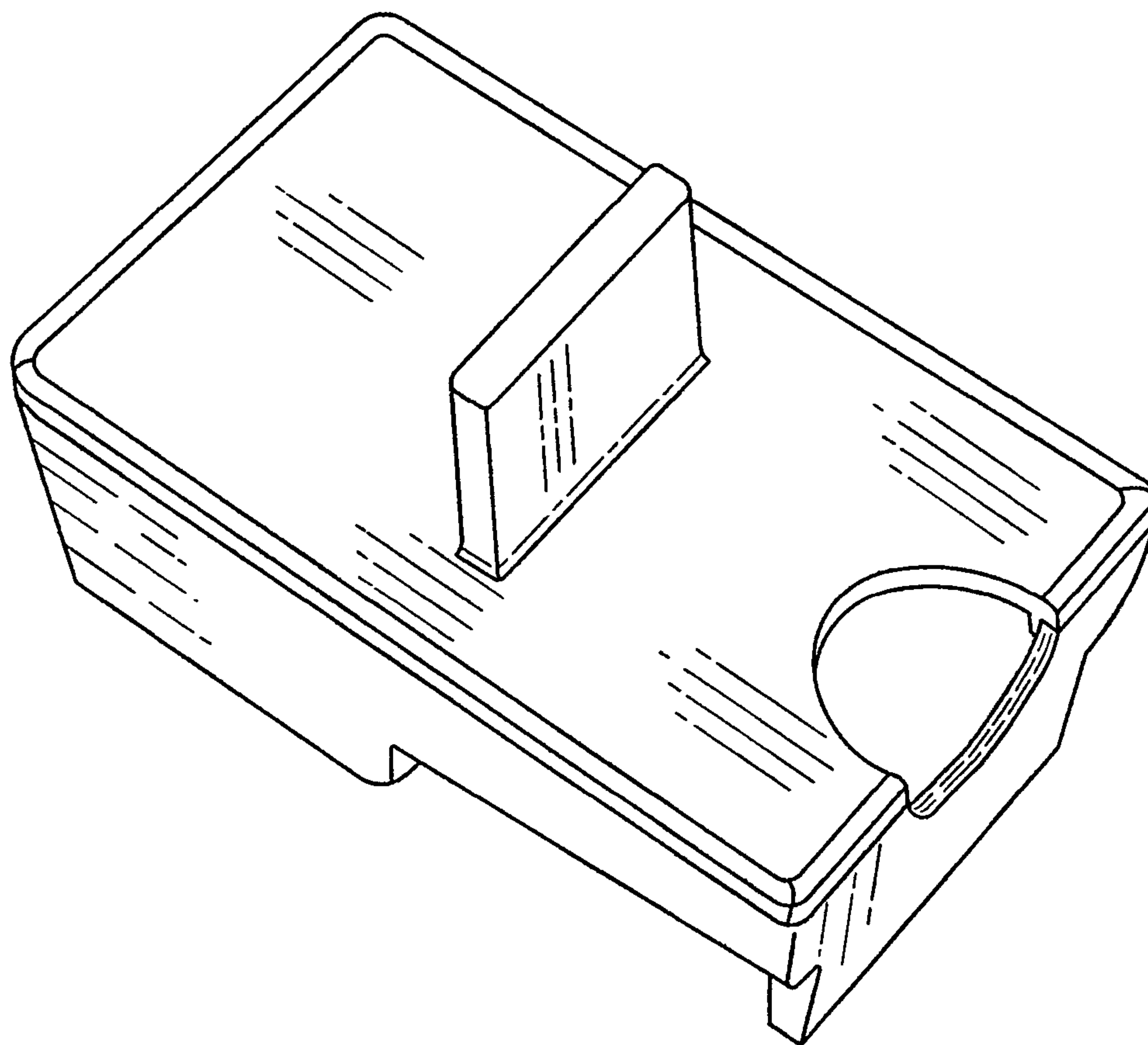
D381,229 S \* 7/1997 Yemini ..... D6/525  
7,080,416 B1 \* 7/2006 Portnell ..... D6/525  
D690,127 S \* 9/2013 Markwick et al. .... D6/525

\* cited by examiner

*Primary Examiner* — Brian N Vinson

**1 Claim, 9 Drawing Sheets**





**FIG. 1**

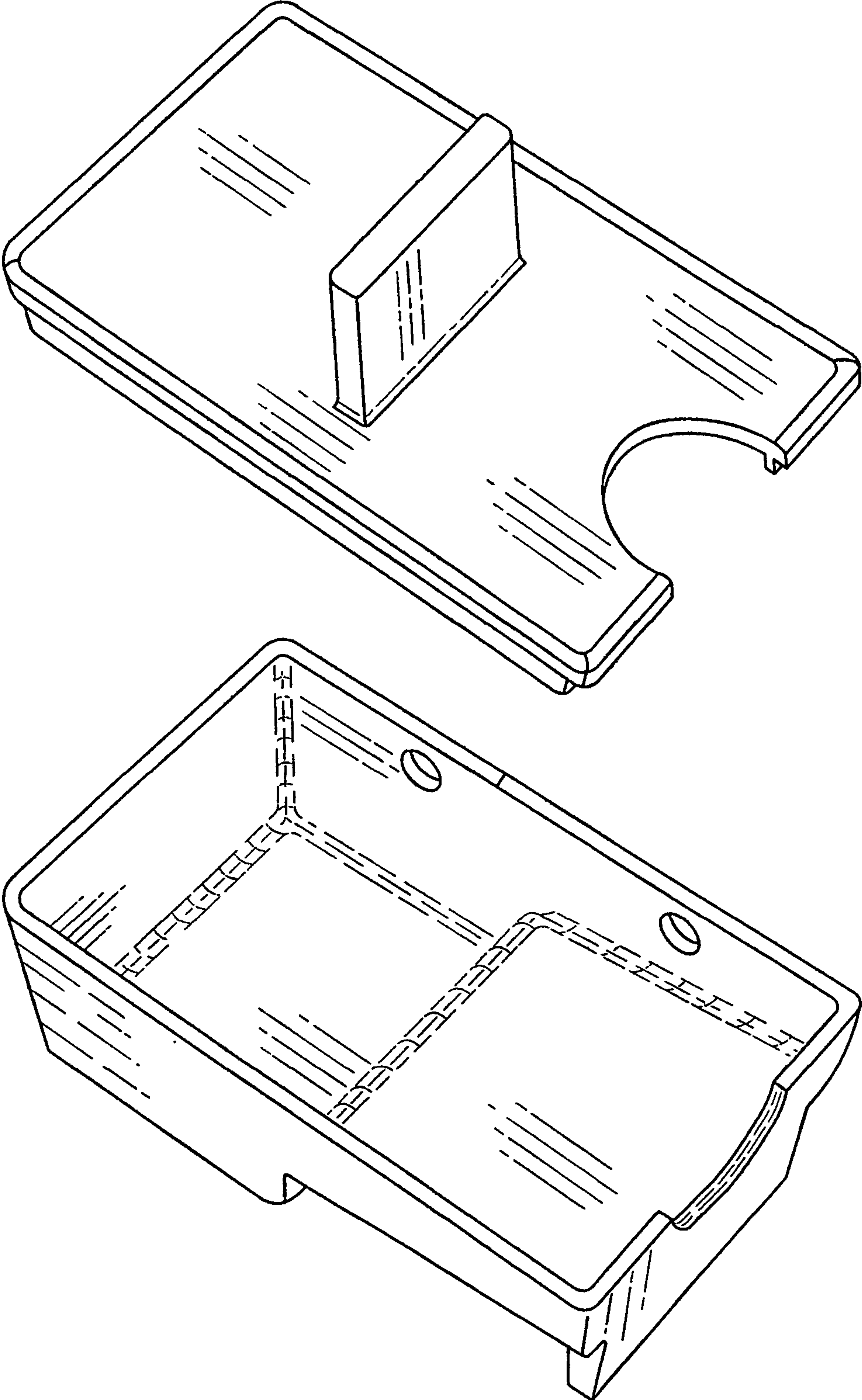
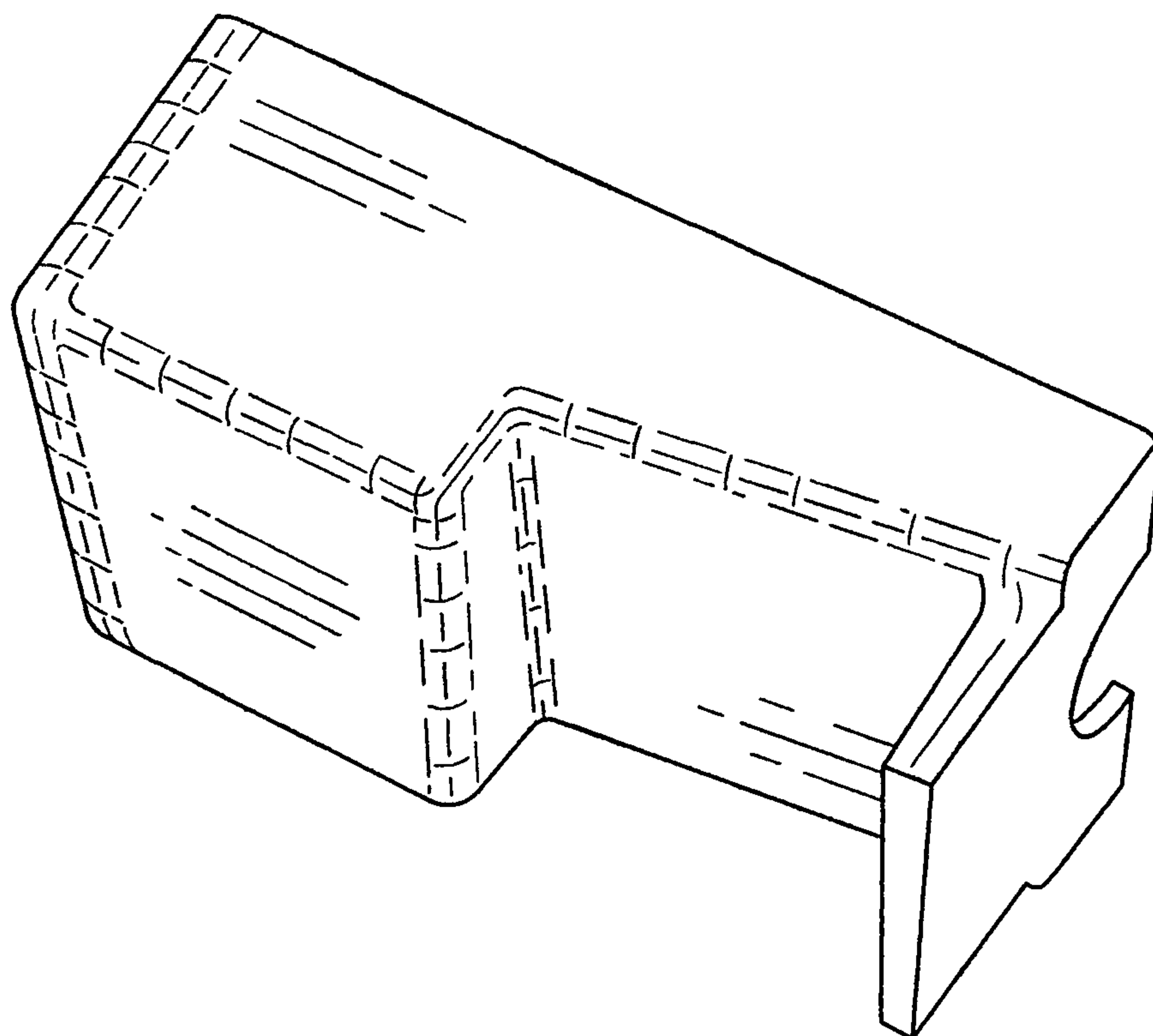
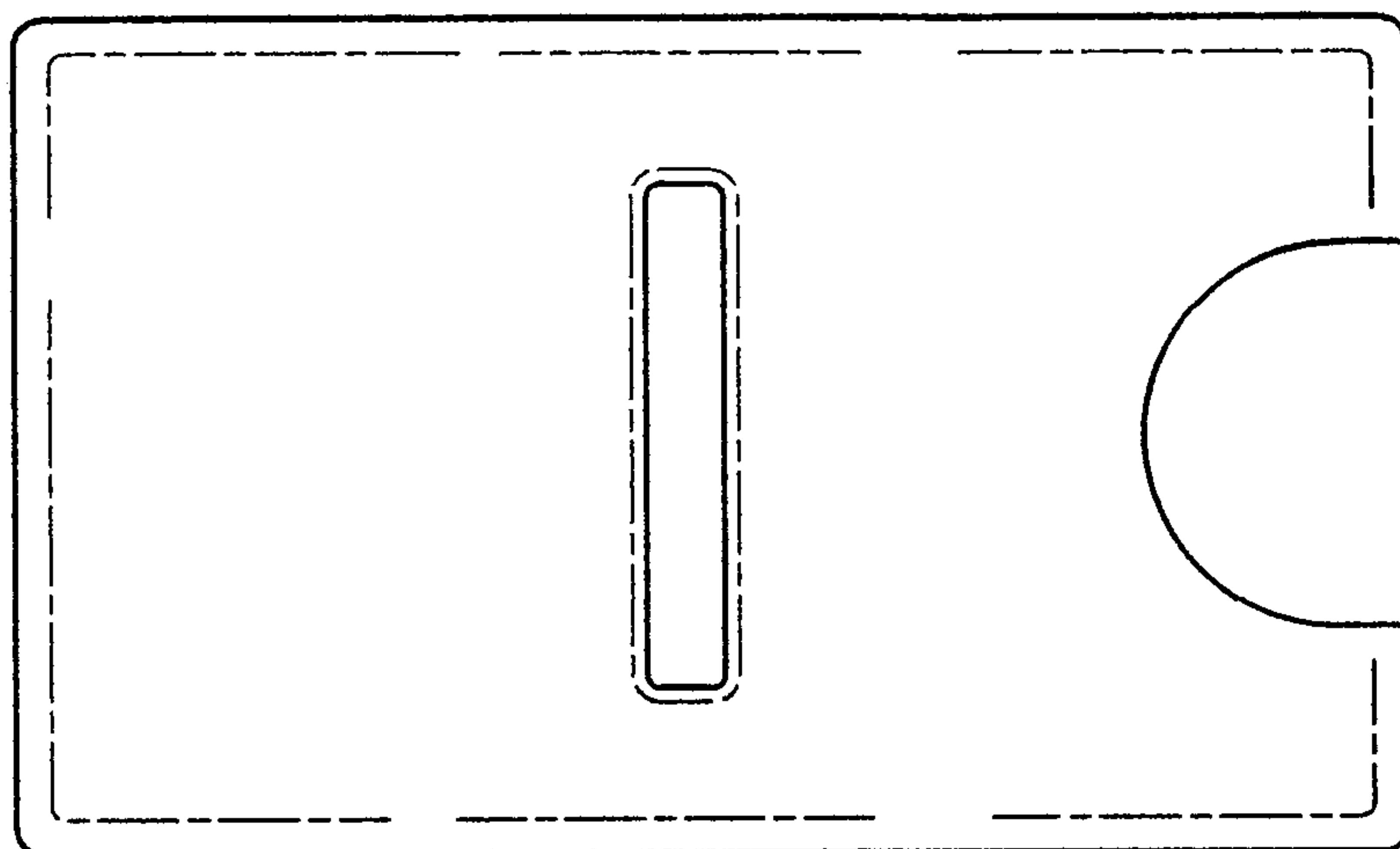


FIG. 2

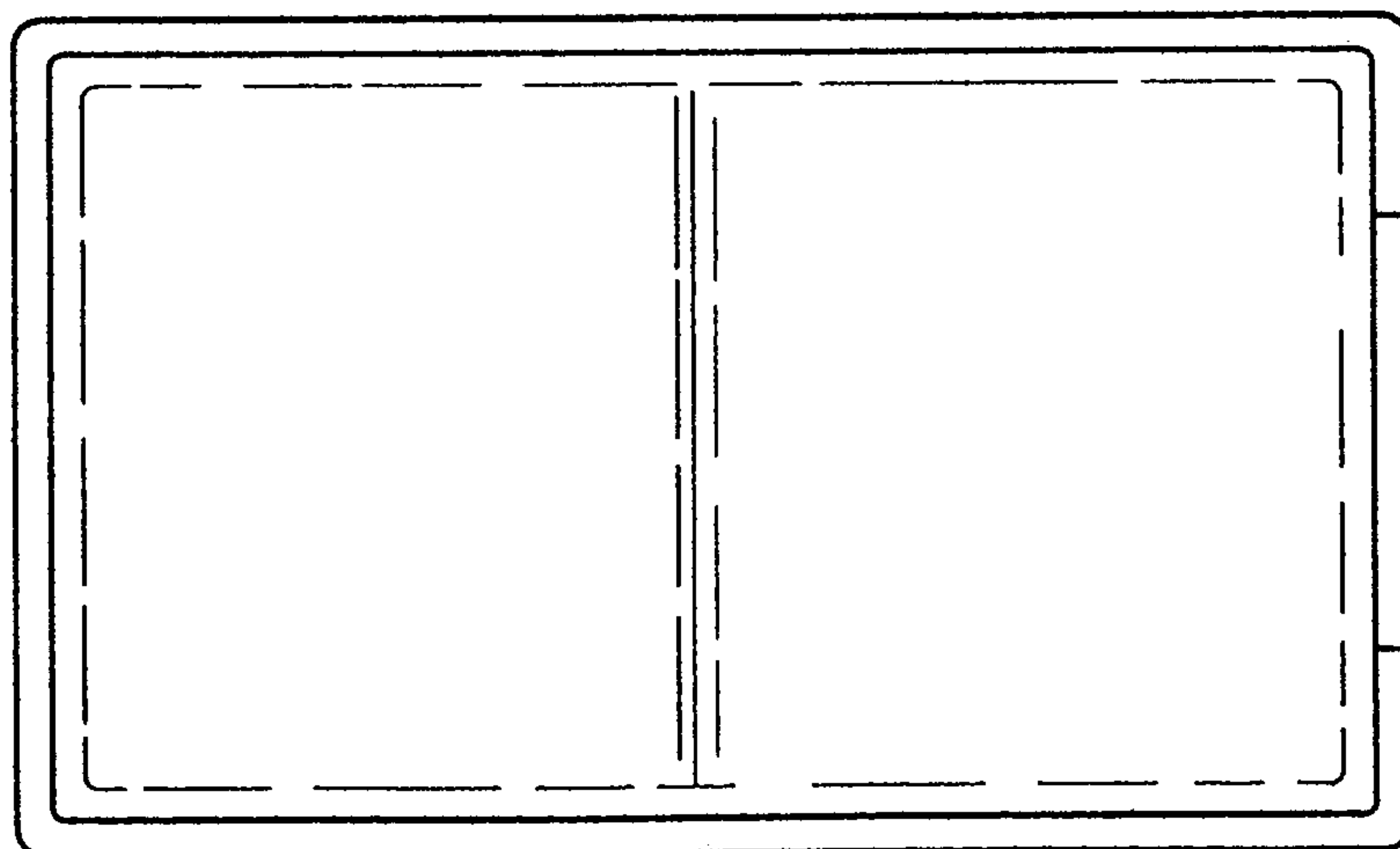


**FIG. 3**

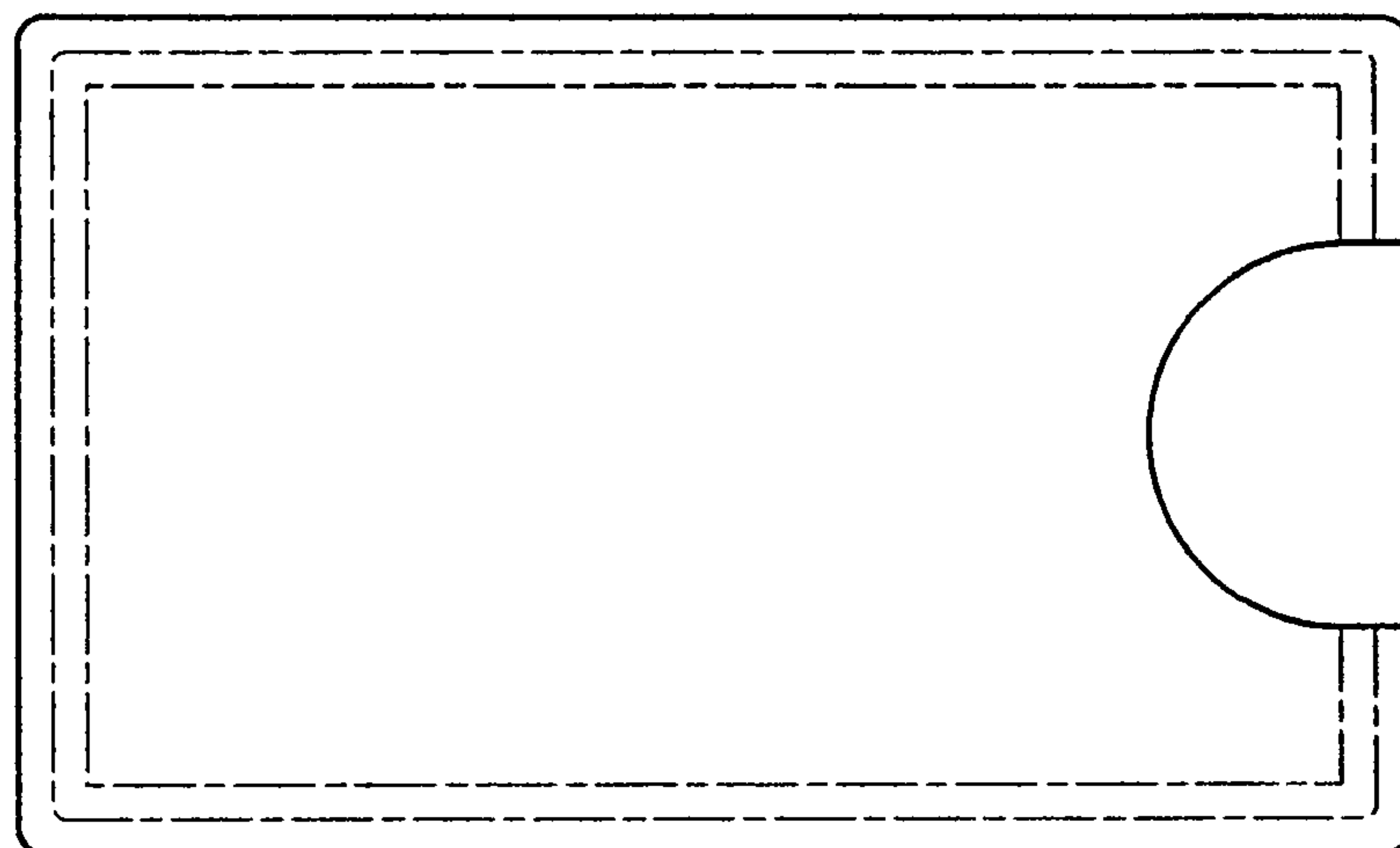




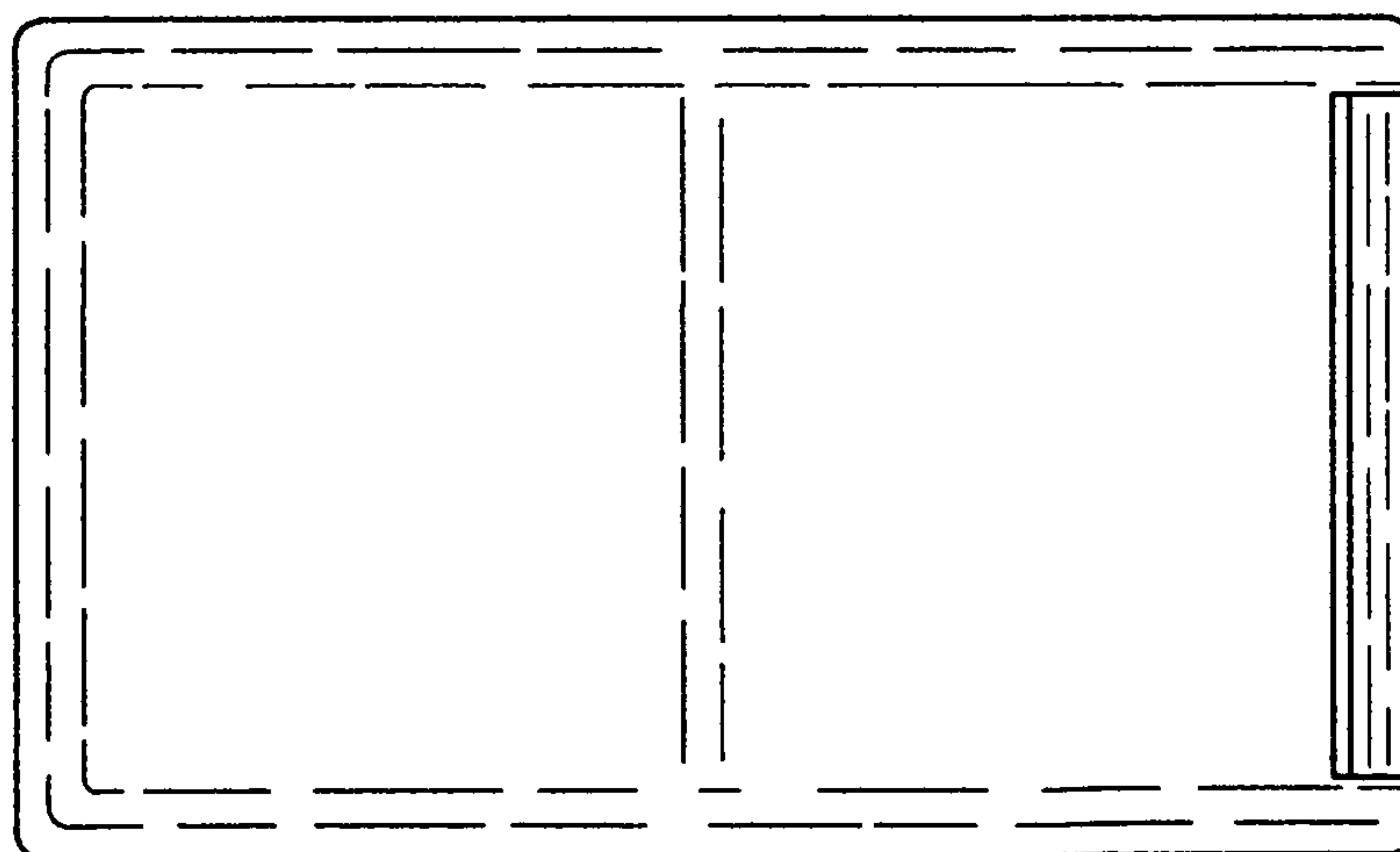
**FIG. 4**



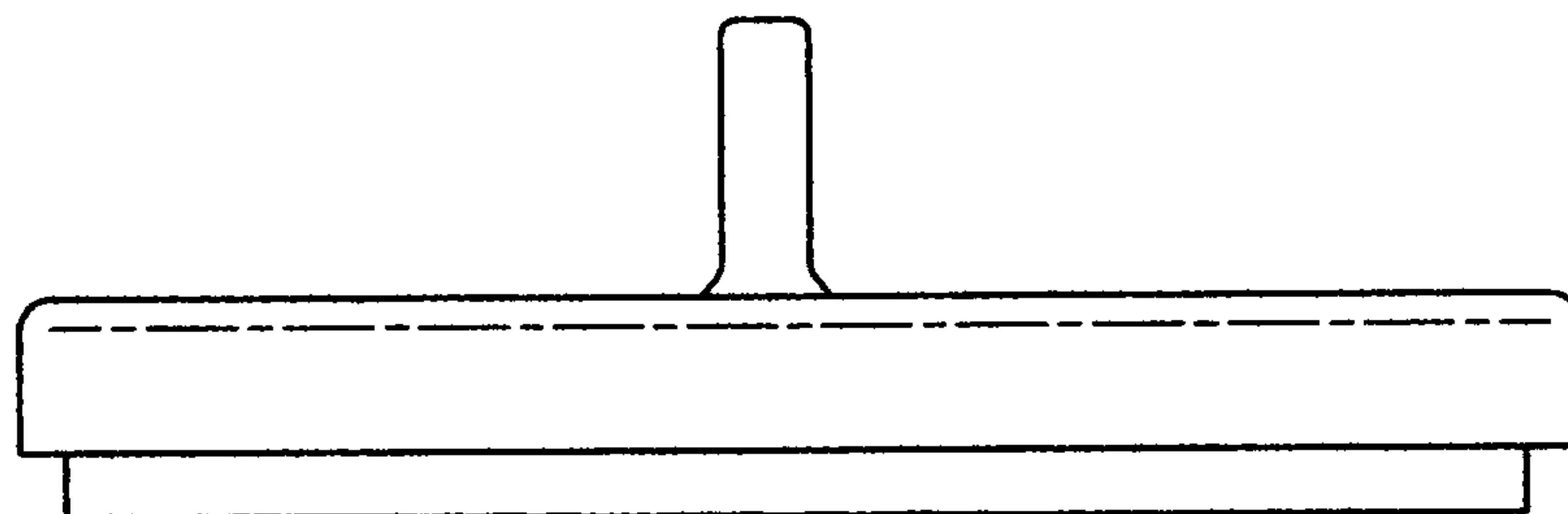
**FIG. 5**



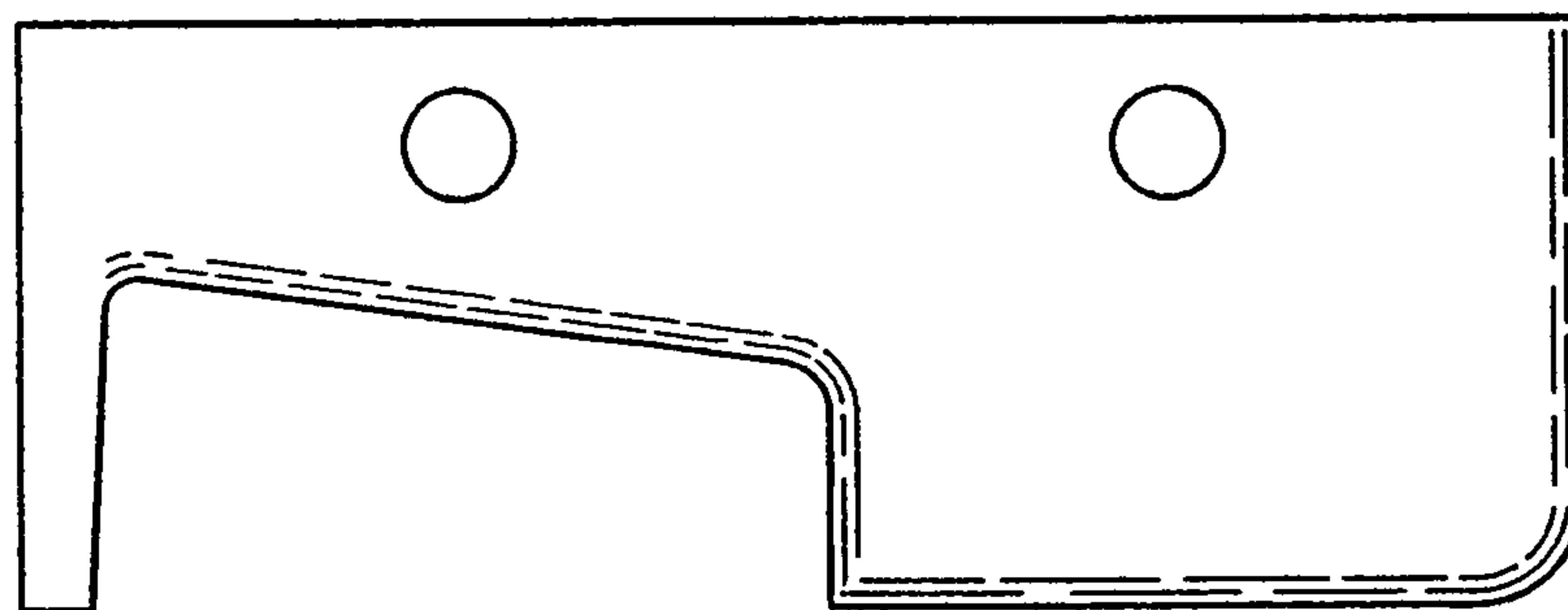
*FIG. 6*



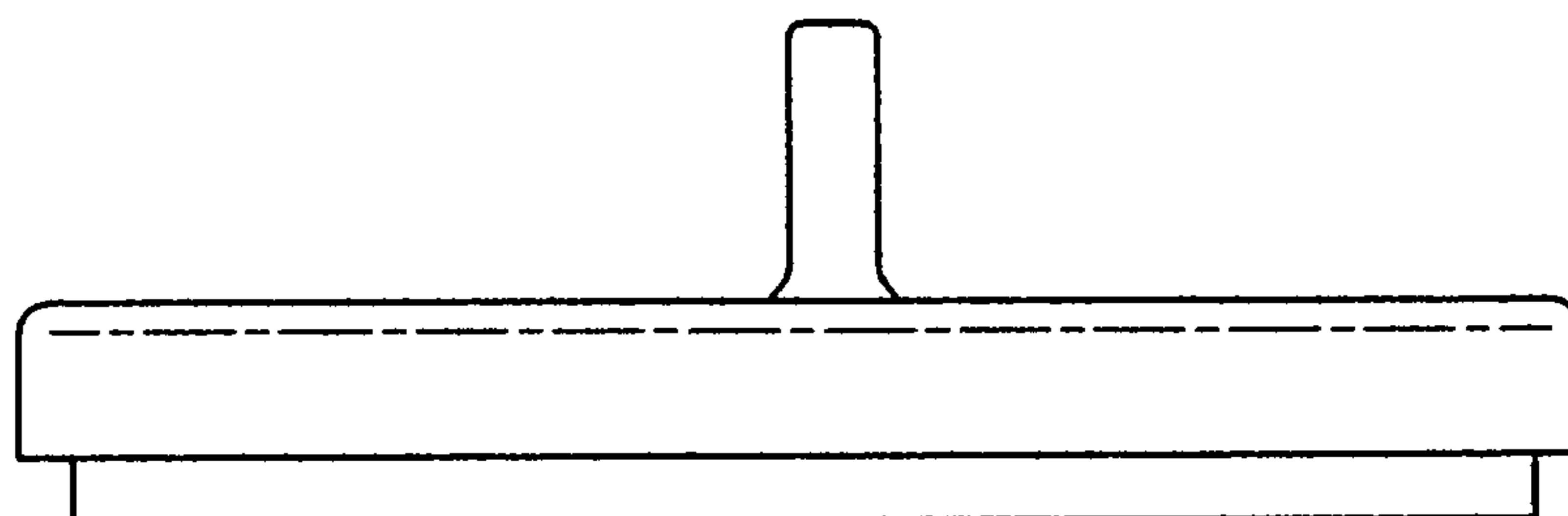
*FIG. 7*



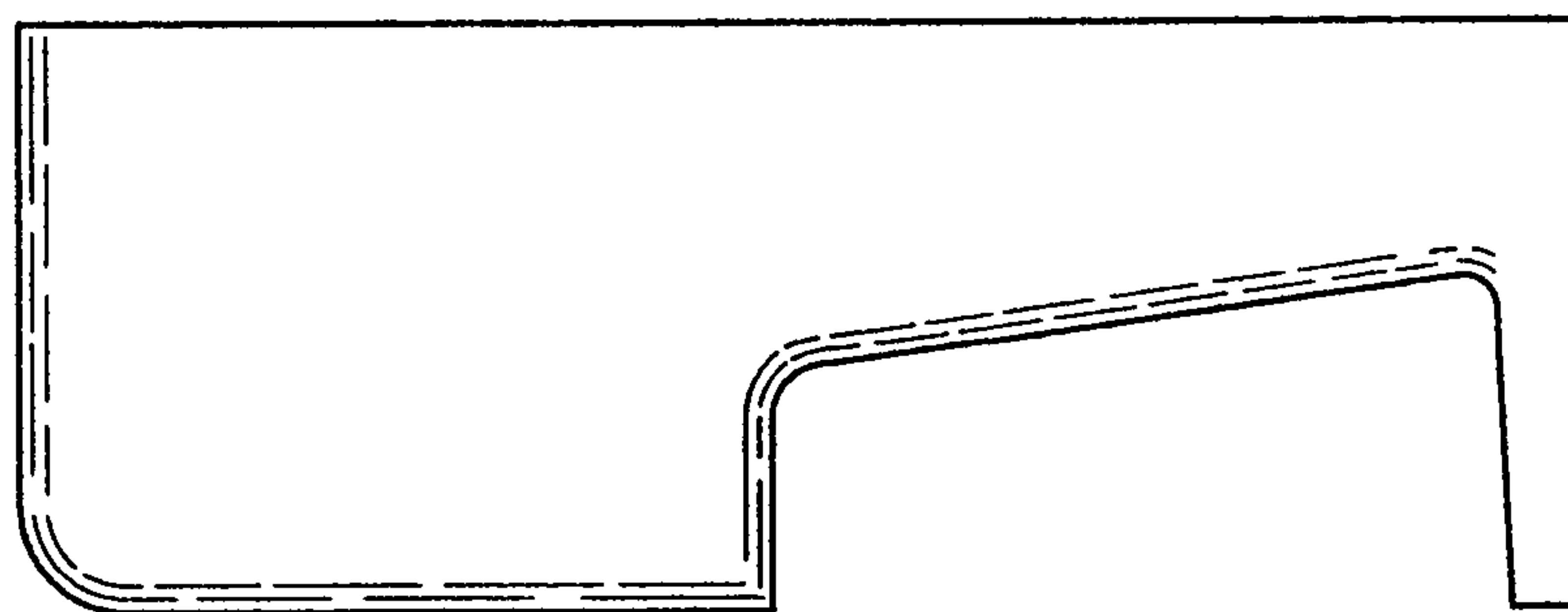
*FIG. 8*



*FIG. 9*

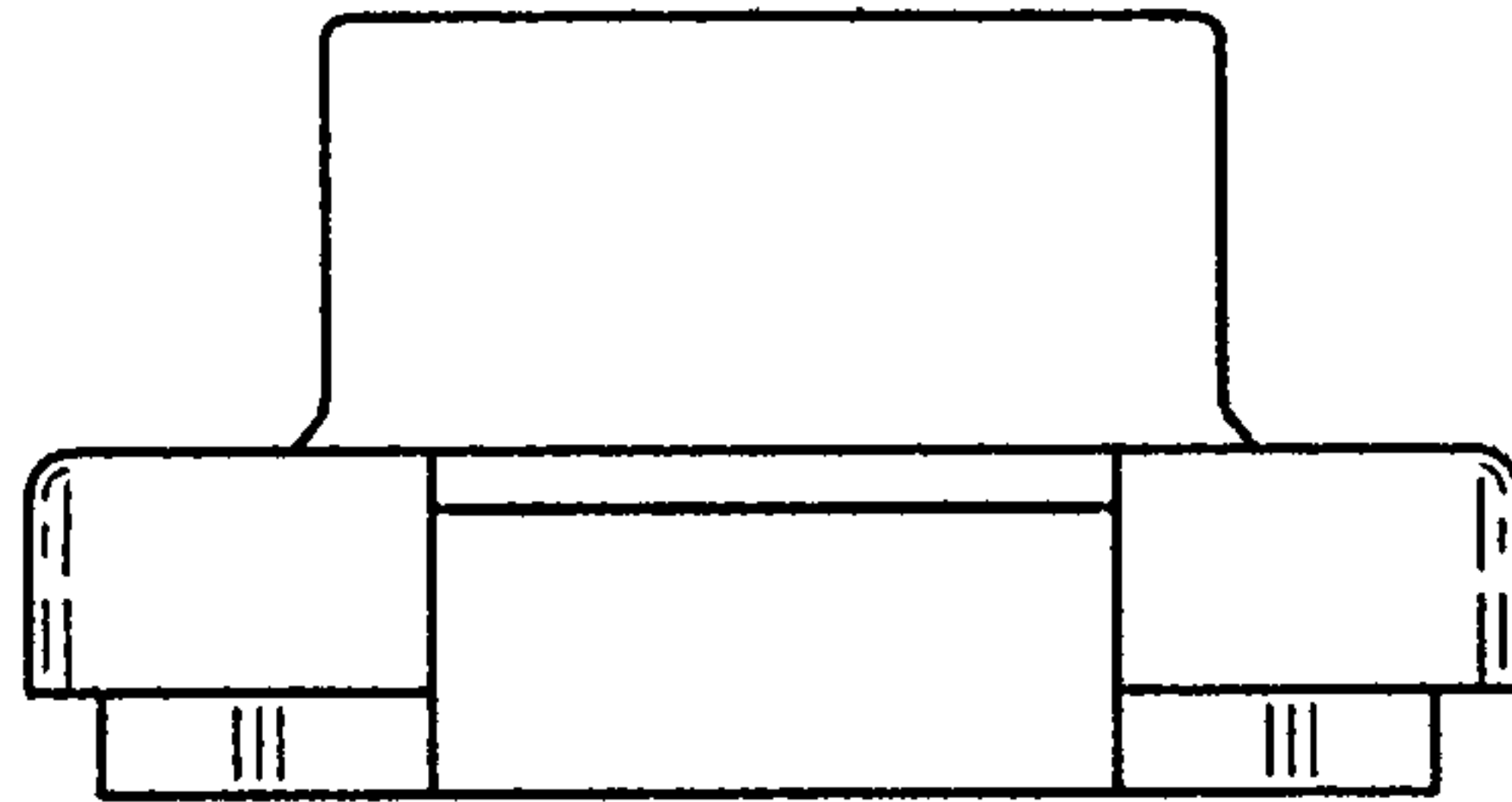


*FIG. 10*

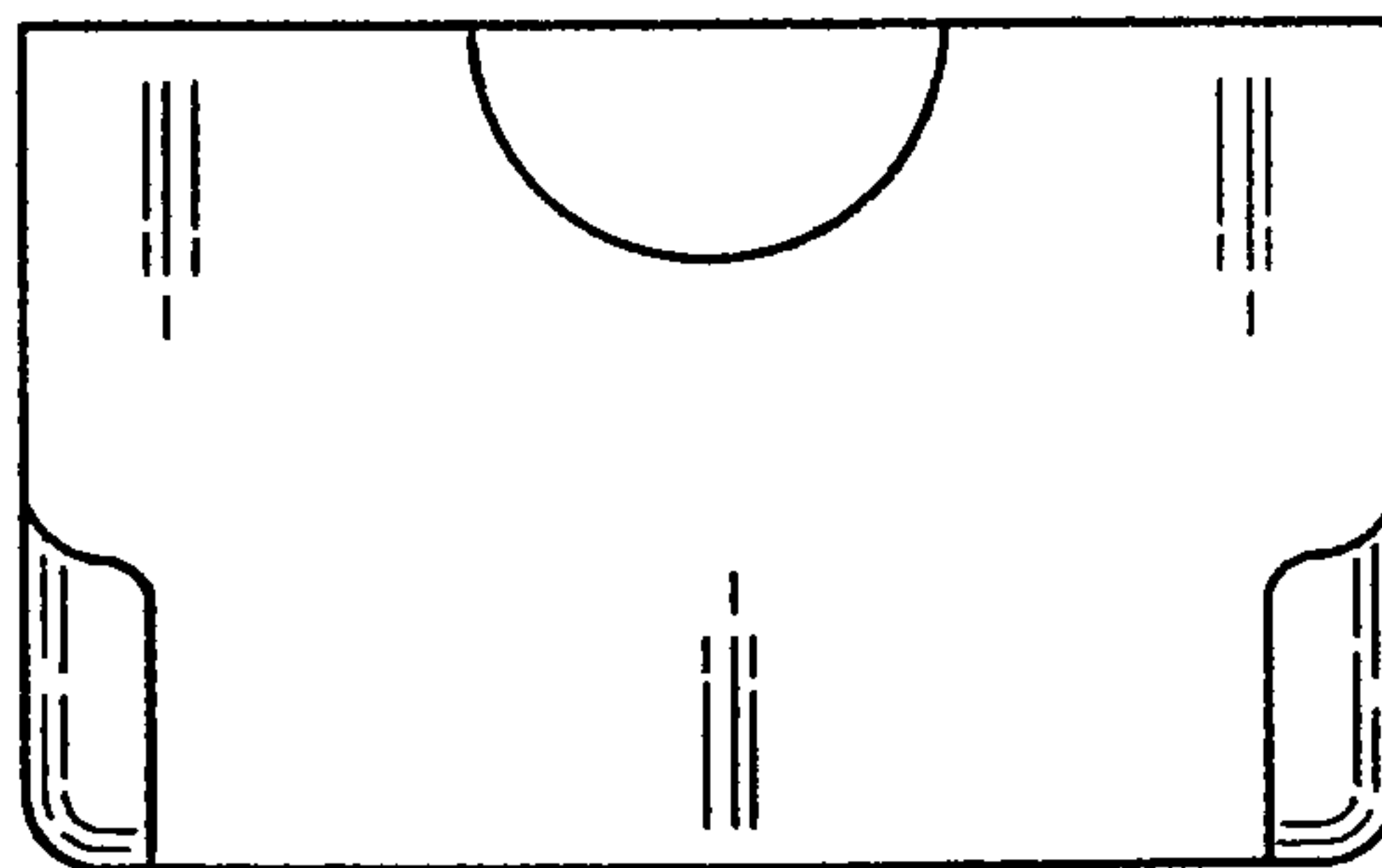


*FIG. 11*

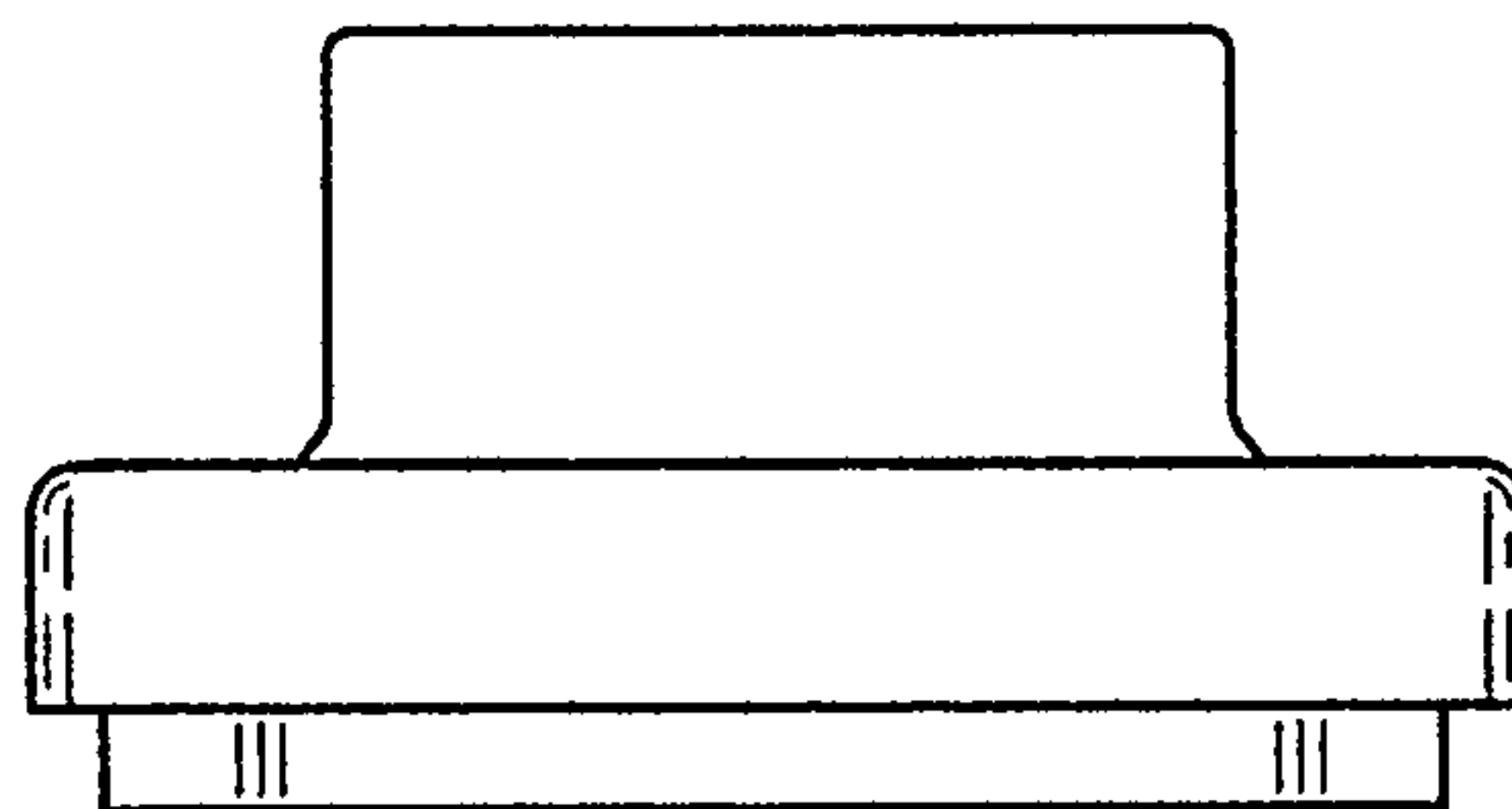




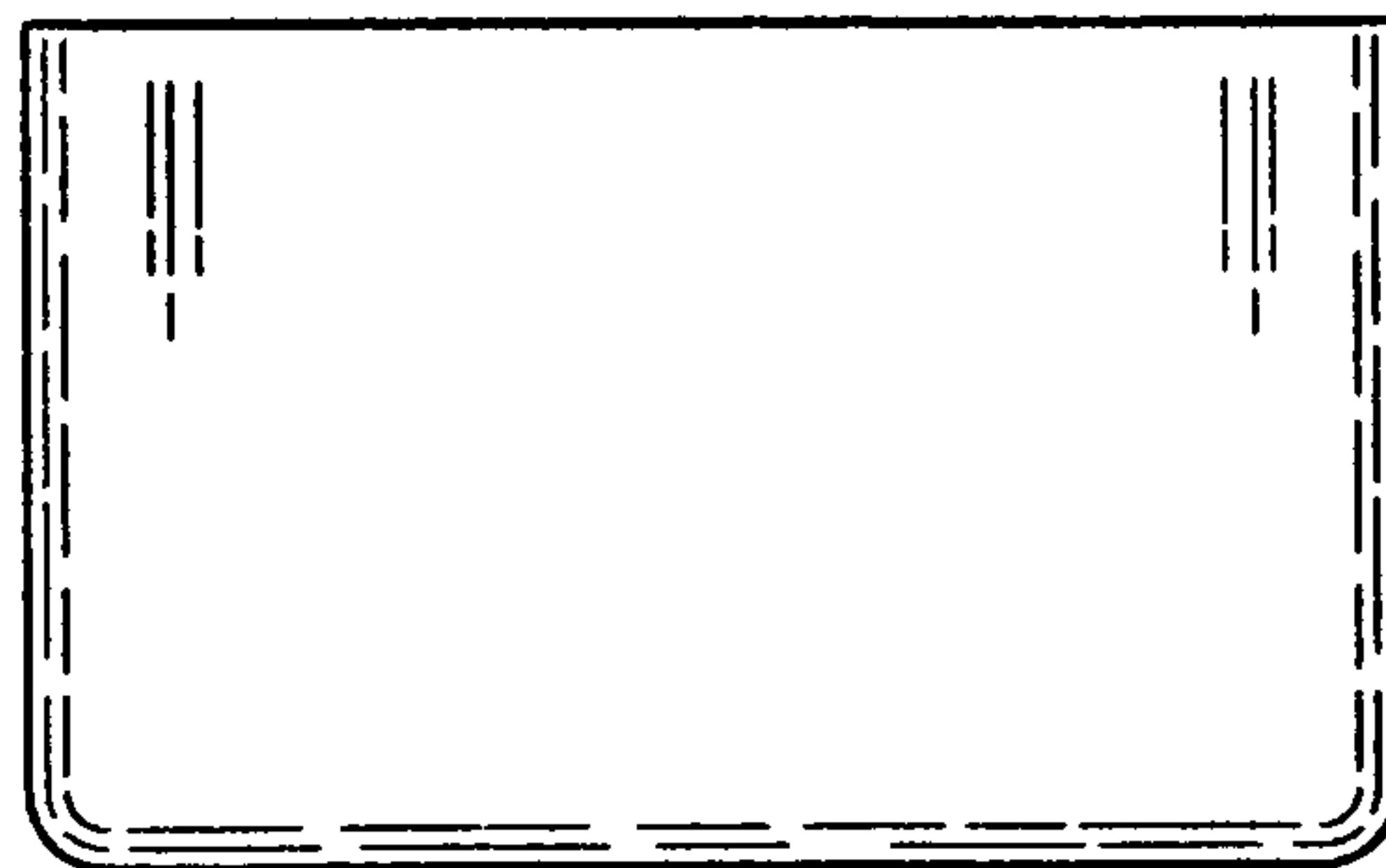
*FIG. 12*



*FIG. 13*



*FIG. 14*



*FIG. 15*