



US00D726893S

(12) **United States Design Patent**  
**Müller**

(10) **Patent No.:** **US D726,893 S**

(45) **Date of Patent:** **\*\* \*Apr. 14, 2015**

(54) **FRAGRANCE DISPENSER**

(71) Applicant: **Tomil s.r.o.**, Vysoké Mýto (CZ)

(72) Inventor: **Tomáš Müller**, Hradec Králové (CZ)

(73) Assignee: **Tomil s.r.o.**, Vysoke Myto (CZ)

(\*) Notice: This patent is subject to a terminal disclaimer.

(\*\*) Term: **14 Years**

(21) Appl. No.: **29/439,053**

(22) Filed: **Dec. 6, 2012**

(30) **Foreign Application Priority Data**

Jun. 8, 2012 (EP) ..... 002054668-006

(51) **LOC (10) Cl.** ..... **28-99**

(52) **U.S. Cl.**  
USPC ..... **D23/366**

(58) **Field of Classification Search**  
CPC ..... A61L 9/00; A61L 9/02; A61L 9/03;  
A61L 9/032; A61L 9/035; A61L 9/037;  
A61L 9/04; A61L 9/12; A61L 9/22  
USPC ..... D23/355-369; D28/5, 6; 261/DIG. 17,  
261/DIG. 42, DIG. 65, DIG. 88, DIG. 89;  
392/386, 390, 394, 395; 239/34, 44,  
239/53, 55, 56, 326; D26/14, 17, 98, 9, 22,  
D26/24; D11/131.1; D7/509, 522, 524, 537  
See application file for complete search history.

(56) **References Cited**

**U.S. PATENT DOCUMENTS**

D262,136 S \* 12/1981 Patrigot ..... D23/369  
D366,108 S \* 1/1996 Traylor et al. .... D23/368

D393,901 S \* 4/1998 Kuhn ..... D23/368  
D422,350 S \* 4/2000 Wu ..... D23/367  
D483,461 S \* 12/2003 Millan ..... D23/366

(Continued)

**OTHER PUBLICATIONS**

Certificate to Registration dated Dec. 15, 2009 from Office for Harmonization in the Internal Market (OHIM) for application No. 001647579-0001.

(Continued)

*Primary Examiner* — Sandra Snapp

(74) *Attorney, Agent, or Firm* — Ohlandt, Greeley, Ruggiero & Perle, LLP

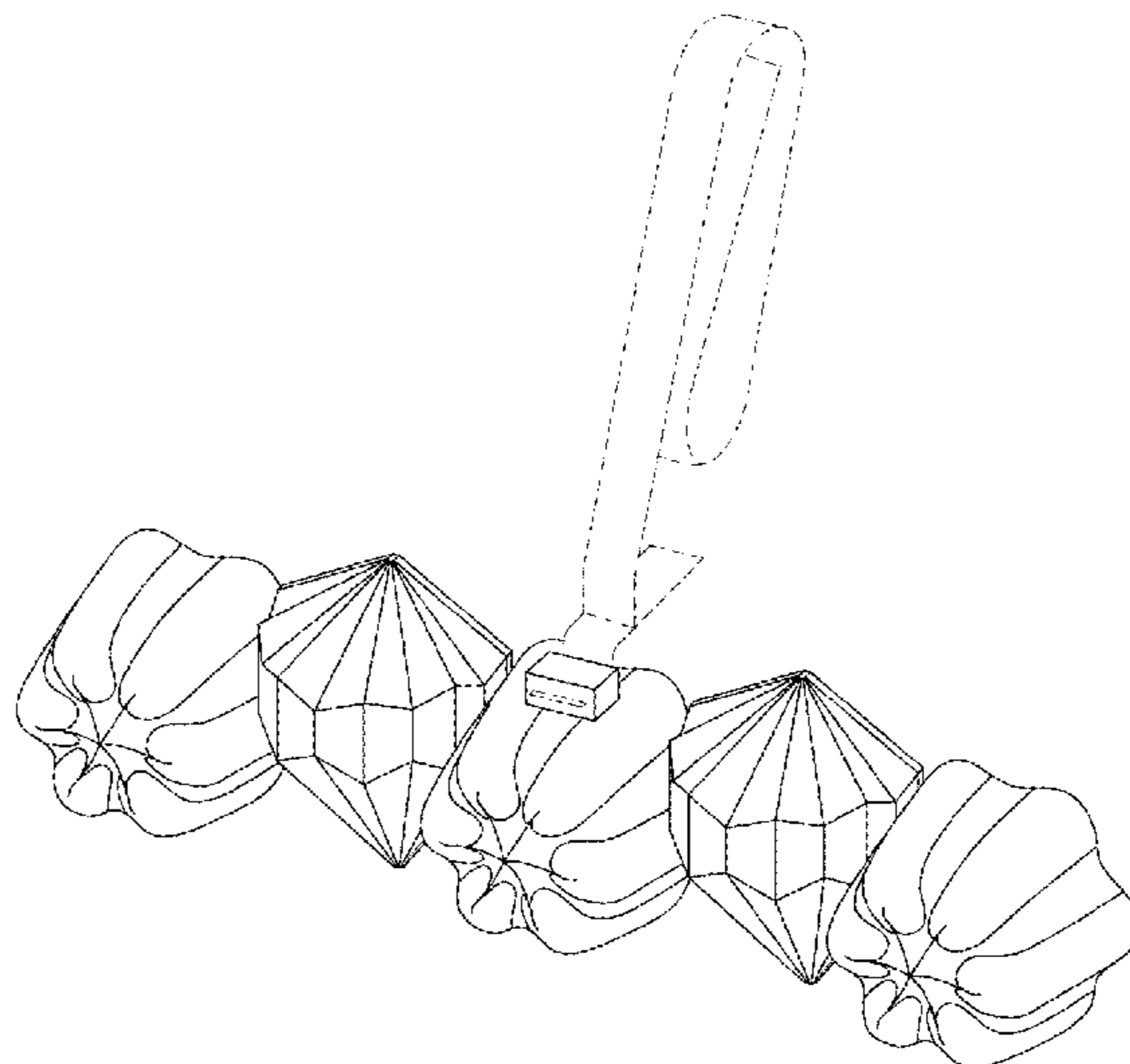
(57) **CLAIM**

The ornamental design for the fragrance dispenser, as shown and described.

**DESCRIPTION**

FIG. 1 is a front, top perspective view of a fragrance dispenser according to the present disclosure;  
FIG. 2 is a front, bottom perspective view of the fragrance dispenser of FIG. 1;  
FIG. 3 is a front elevation view of the fragrance dispenser of FIG. 1;  
FIG. 4 is a back elevation view of the fragrance dispenser of FIG. 1;  
FIG. 5 is a side elevation view of the fragrance dispenser of FIG. 1, the opposite side being a mirror image thereof;  
FIG. 6 is a top plan view of the fragrance dispenser of FIG. 1; and,  
FIG. 7 is a bottom plan view of the fragrance dispenser of FIG. 1.  
The broken lines shown in the drawings are for illustrative purposes only and form no part of the claimed design.

**1 Claim, 3 Drawing Sheets**



(56)

**References Cited**

U.S. PATENT DOCUMENTS

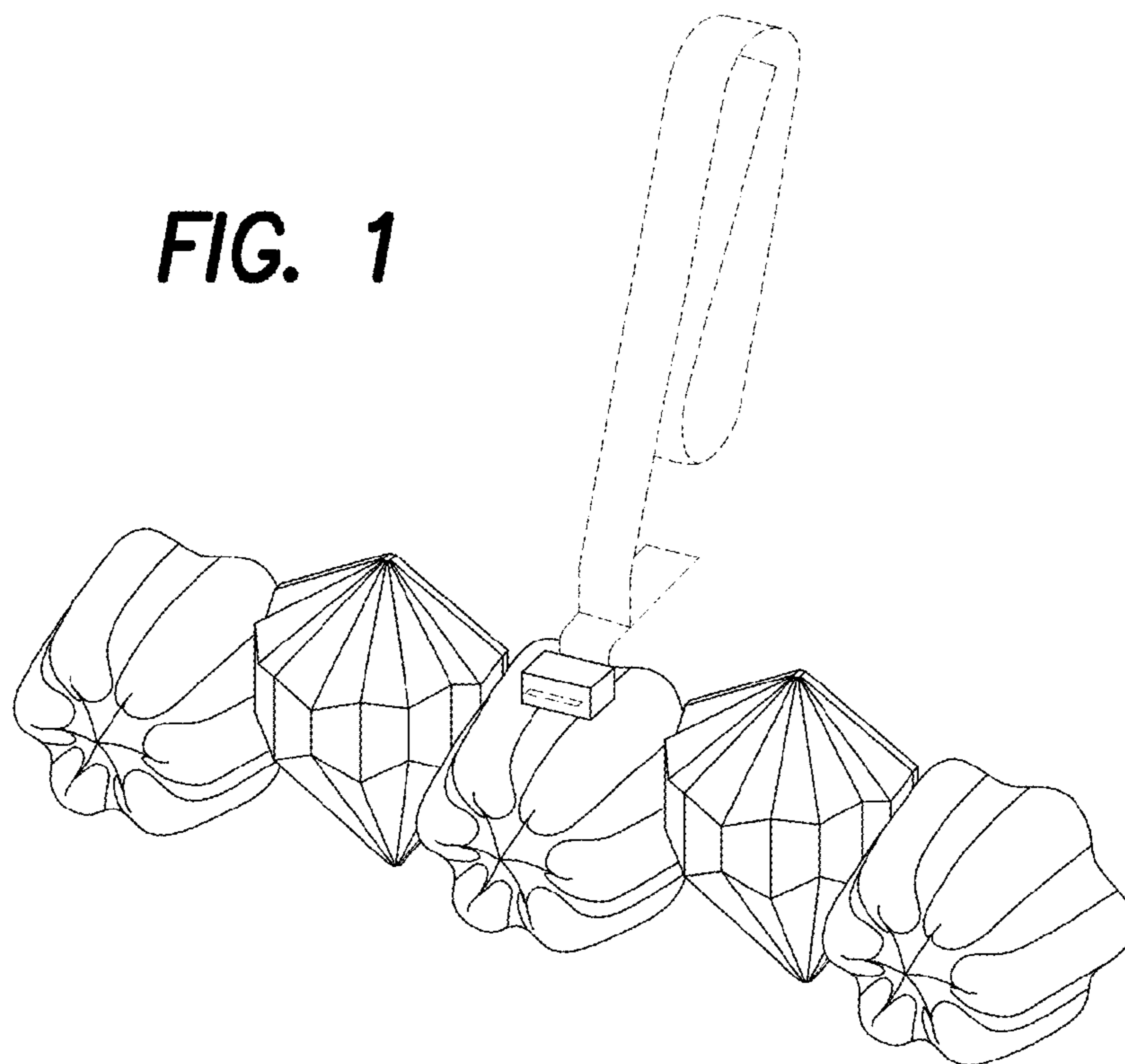
D488,856 S \* 4/2004 Millan ..... D23/366  
D522,119 S \* 5/2006 Baraky et al. .... D23/366  
D530,806 S \* 10/2006 Holquin-Remolina ..... D23/364  
D534,093 S \* 12/2006 Anastasiadis ..... D11/81  
D553,230 S \* 10/2007 Caserta et al. .... D23/360  
D577,803 S \* 9/2008 Garcia Fabrega et al. ... D23/366  
D577,804 S \* 9/2008 Fabrega et al. .... D23/366  
D578,199 S \* 10/2008 Fabrega et al. .... D23/366  
D582,026 S \* 12/2008 Weggelaar ..... D23/366  
D594,953 S \* 6/2009 King et al. .... D23/366  
D597,648 S \* 8/2009 Heflin, III ..... D23/367  
D604,826 S \* 11/2009 Lesniak et al. .... D23/367  
D614,279 S \* 4/2010 Lesniak et al. .... D23/367  
D646,769 S \* 10/2011 Angel et al. .... D23/366

OTHER PUBLICATIONS

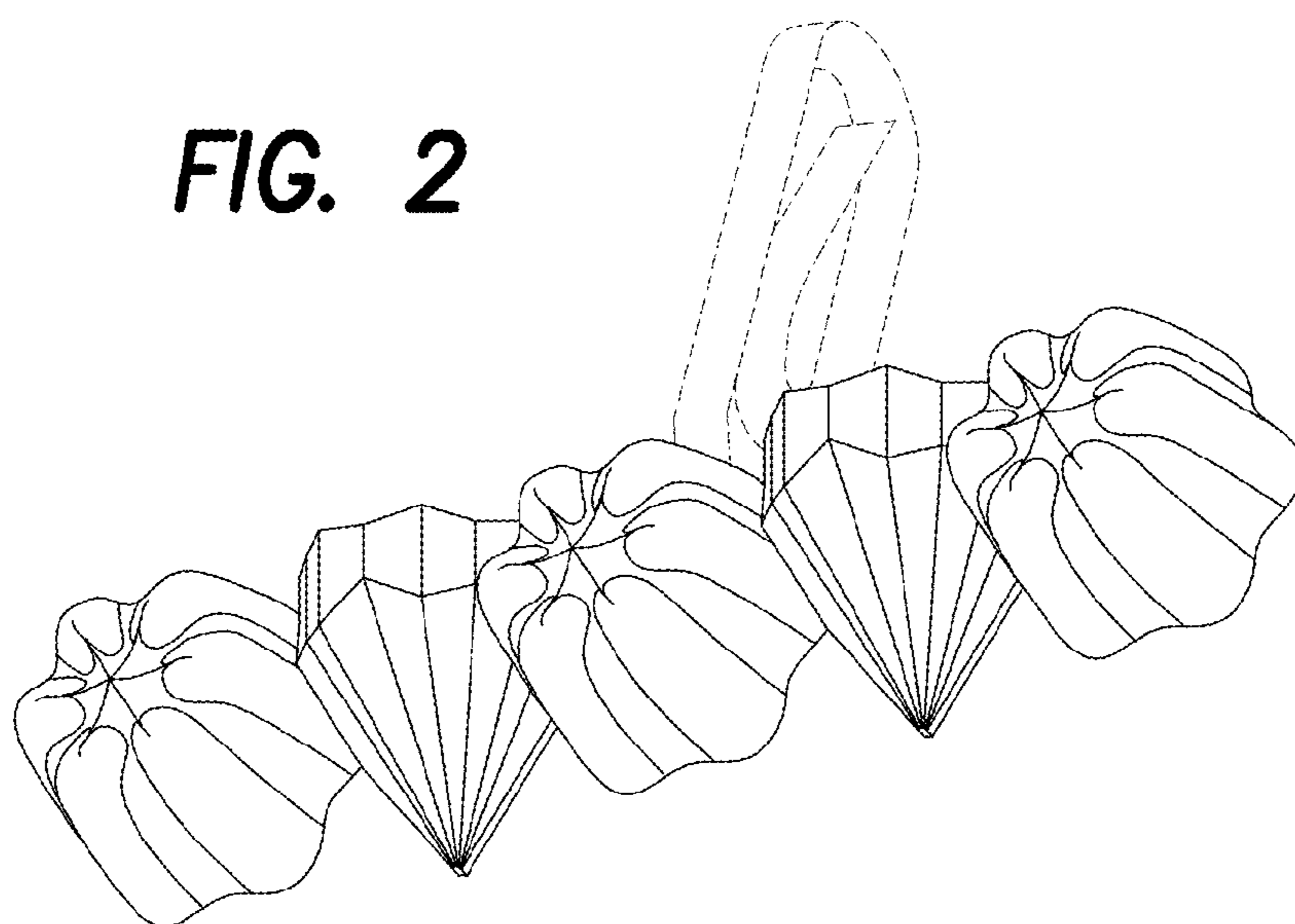
Certificate to Registration dated Dec. 15, 2009 from Office for Harmonization in the Internal Market (OHIM) for application No. 001647579-0002.  
Certificate to Registration dated Dec. 15, 2009 from Office for Harmonization in the Internal Market (OHIM) for application No. 001647579-0003.  
Certificate to Registration dated Dec. 15, 2009 from Office for Harmonization in the Internal Market (OHIM) for application No. 001647579-0004.  
Certificate to Registration dated Dec. 15, 2009 from Office for Harmonization in the Internal Market (OHIM) for application No. 001647579-0005.  
International Design (DM/73018) 1-5, Flushing Systems for Water Closets dated Feb. 1, 2010.

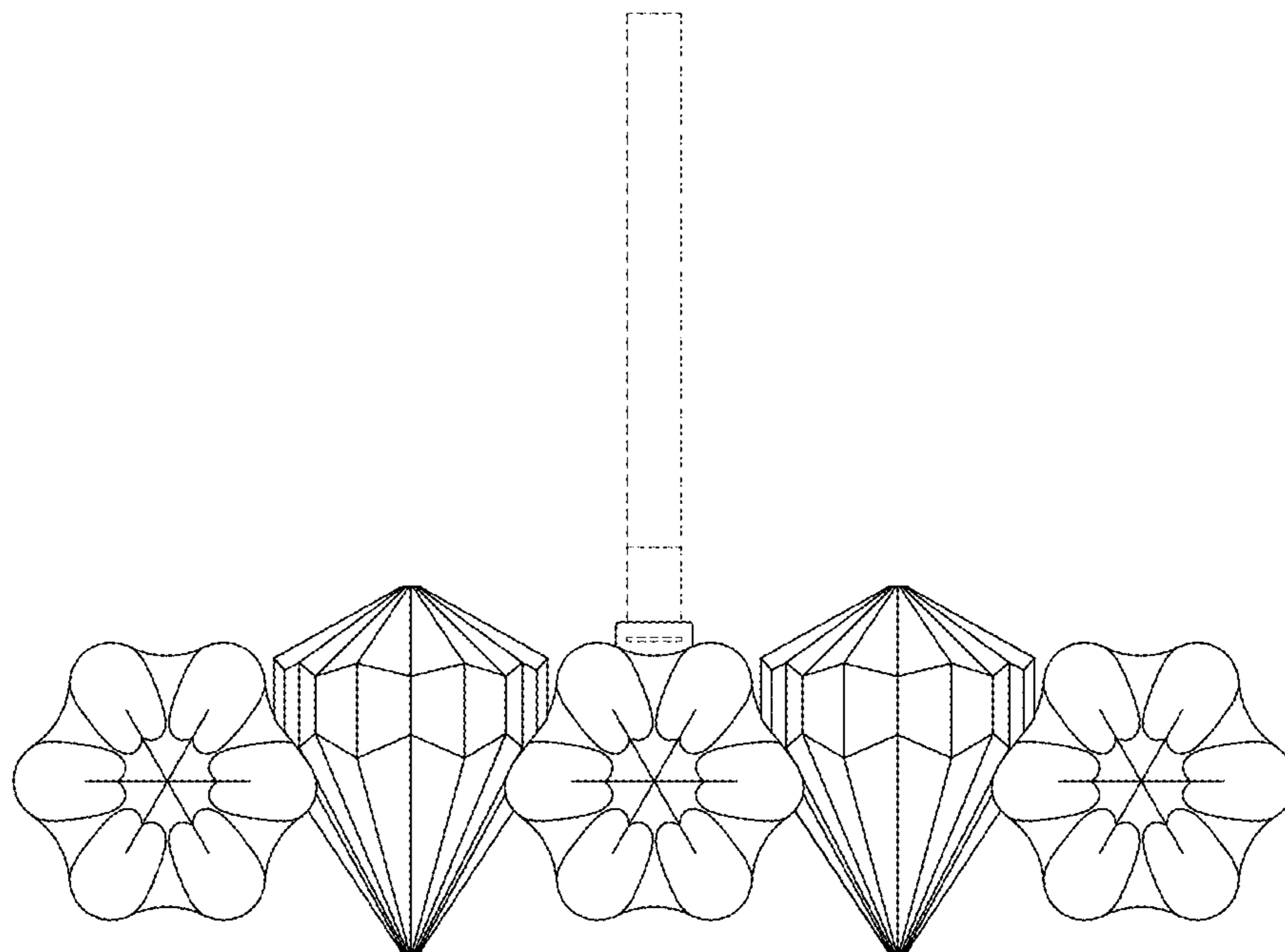
\* cited by examiner

**FIG. 1**

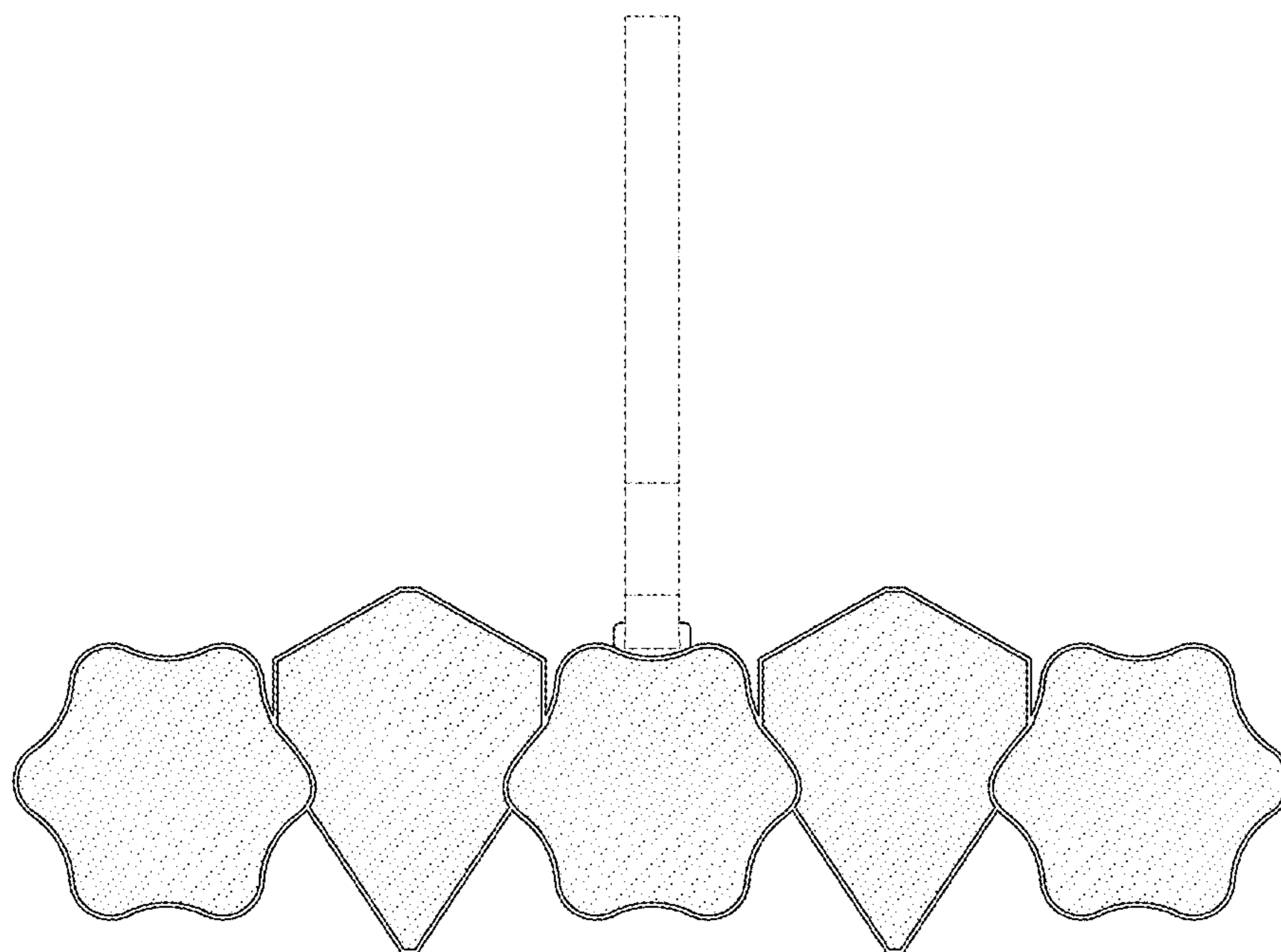


**FIG. 2**



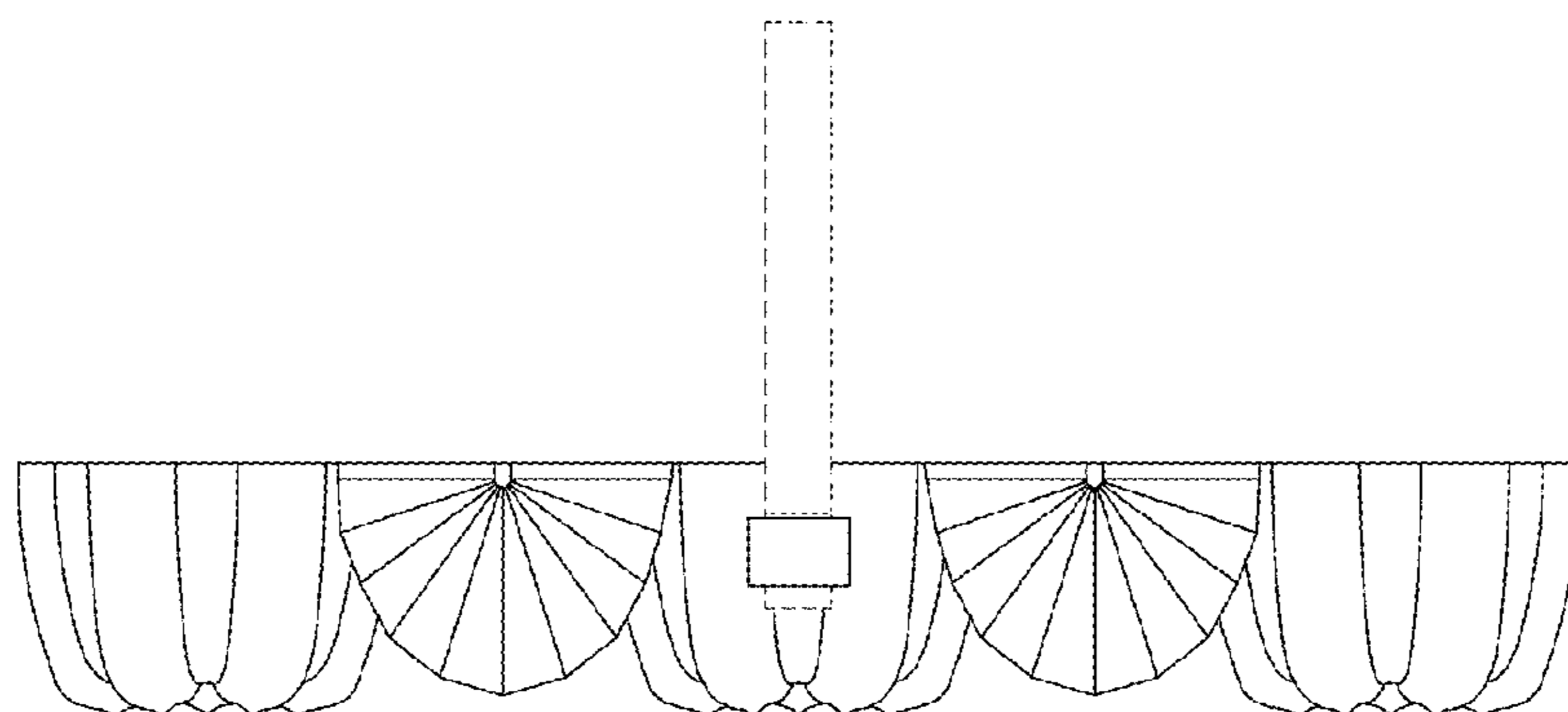
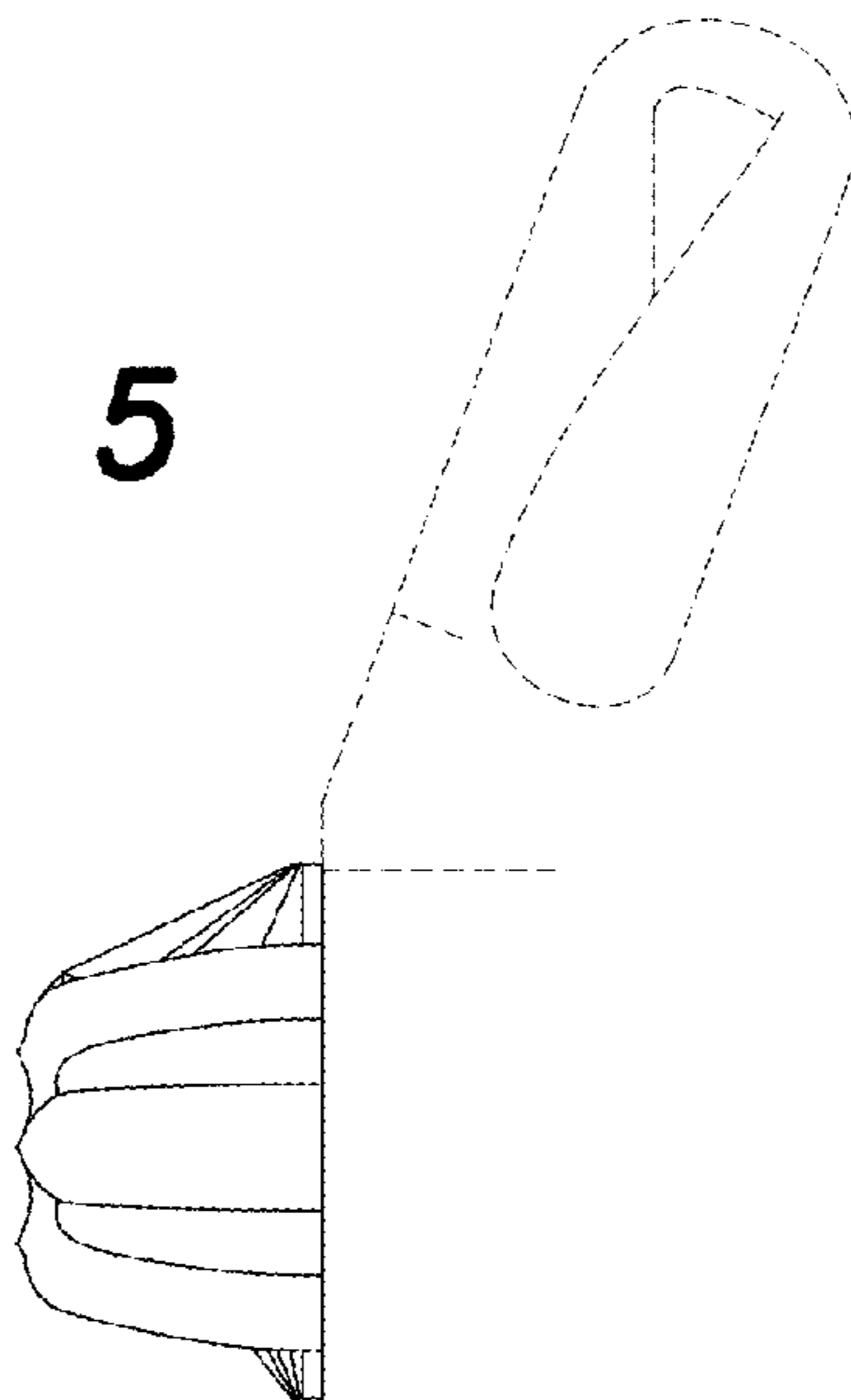


**FIG. 3**

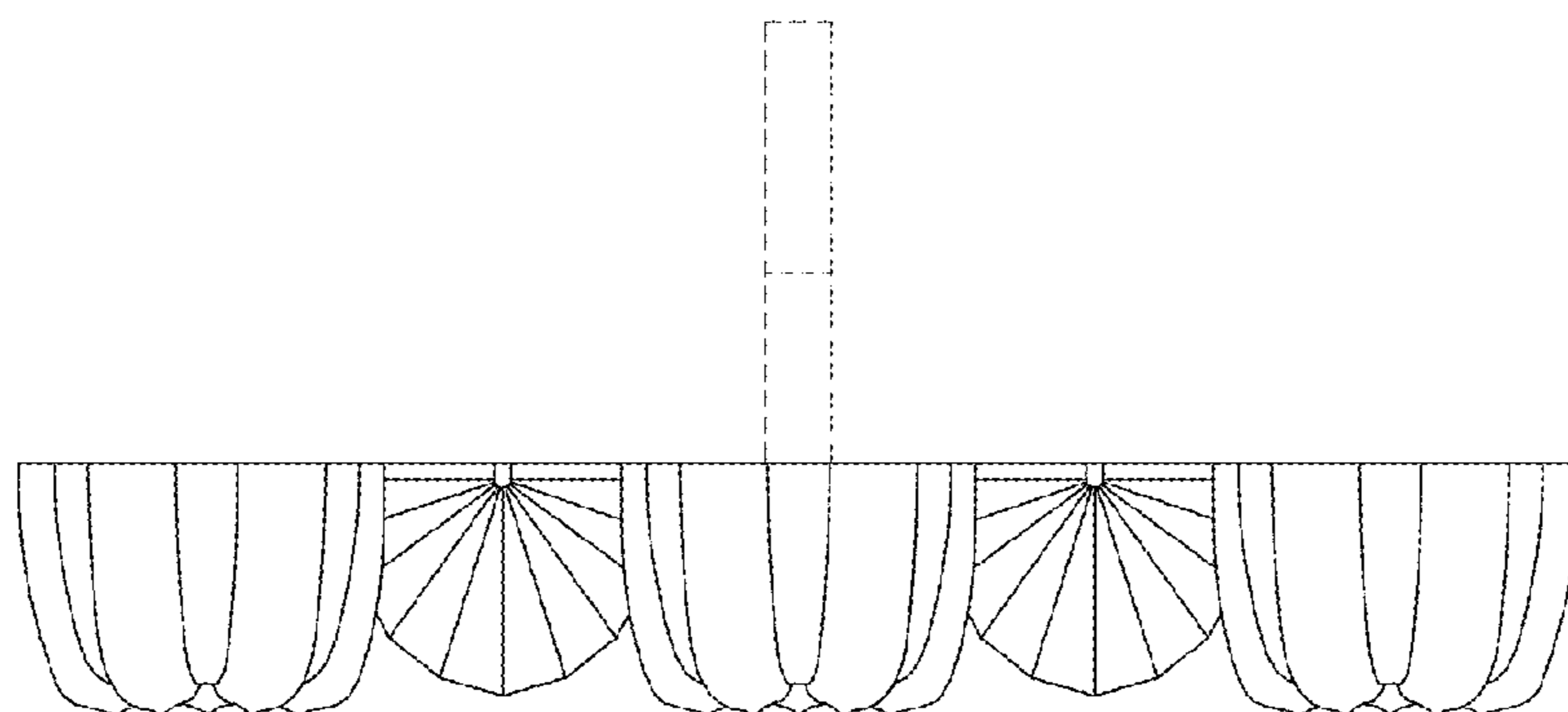


**FIG. 4**

**FIG. 5**



**FIG. 6**



**FIG. 7**