



US00D726714S

(12) **United States Design Patent**
Lim et al.

(10) **Patent No.:** **US D726,714 S**
(45) **Date of Patent:** **** Apr. 14, 2015**

(54) **CONVERTIBLE COMPUTER**

(71) Applicant: **LG Electronics Inc.**, Seoul (KR)

(72) Inventors: **Jaewon Lim**, Gwangmyeong-si (KR);
Gangho Woo, Seoul (KR); **Banhee Lee**,
Seoul (KR); **Taejin Lee**, Seoul (KR)

(73) Assignee: **LG Electronics Inc.**, Seoul (KR)

(**) Term: **14 Years**

(21) Appl. No.: **29/481,245**

(22) Filed: **Feb. 3, 2014**

(30) **Foreign Application Priority Data**

Aug. 6, 2013 (KR) 30-2013-0040573

(51) **LOC (10) Cl.** **14-02**

(52) **U.S. Cl.**
USPC **D14/316**

(58) **Field of Classification Search**

USPC D14/315-327, 331; D18/1, 2, 7, 11;
235/145 A, 145 R; 341/22, 23; 345/104,
345/156, 168, 169, 173; 361/679.08,
361/679.09, 679.11, 679.26, 679.27;
379/433.12; 16/341, 367

See application file for complete search history.

(56) **References Cited**

U.S. PATENT DOCUMENTS

D528,541 S * 9/2006 Maskatia D14/315
D535,292 S * 1/2007 Shi et al. D14/315
7,158,634 B2 * 1/2007 Eromaki 379/433.13

7,599,487 B2 * 10/2009 Lim 379/433.12
7,690,576 B2 * 4/2010 Ladouceur et al. 235/486
D626,547 S * 11/2010 Li et al. D14/316
2005/0044665 A1 * 3/2005 Kuramochi 16/341

* cited by examiner

Primary Examiner — Freda S Nunn

(74) *Attorney, Agent, or Firm* — Birch, Stewart, Kolasch &
Birch, LLP

(57) **CLAIM**

The ornamental design for a convertible computer, as shown
and described.

DESCRIPTION

FIG. 1 is a perspective view of a convertible computer show-
ing our new design;

FIG. 2 is a front view thereof;

FIG. 3 is a rear view thereof;

FIG. 4 is a left side view thereof;

FIG. 5 is a right side view thereof;

FIG. 6 is a top plan view thereof;

FIG. 7 is a bottom plan view thereof;

FIG. 8 is a perspective view thereof showing the state that the
display part has been put up on the main body;

FIG. 9 is a front view of FIG. 8;

FIG. 10 is a rear view of FIG. 8;

FIG. 11 is a left side view of FIG. 8;

FIG. 12 is a right side view of FIG. 8;

FIG. 13 is a top plan view of FIG. 8;

FIG. 14 is a bottom plan view of FIG. 8; and,

FIG. 15 is a rear perspective view of FIG. 8.

The broken lines are for illustrative purposes only and form
no part of the claimed design.

1 Claim, 11 Drawing Sheets

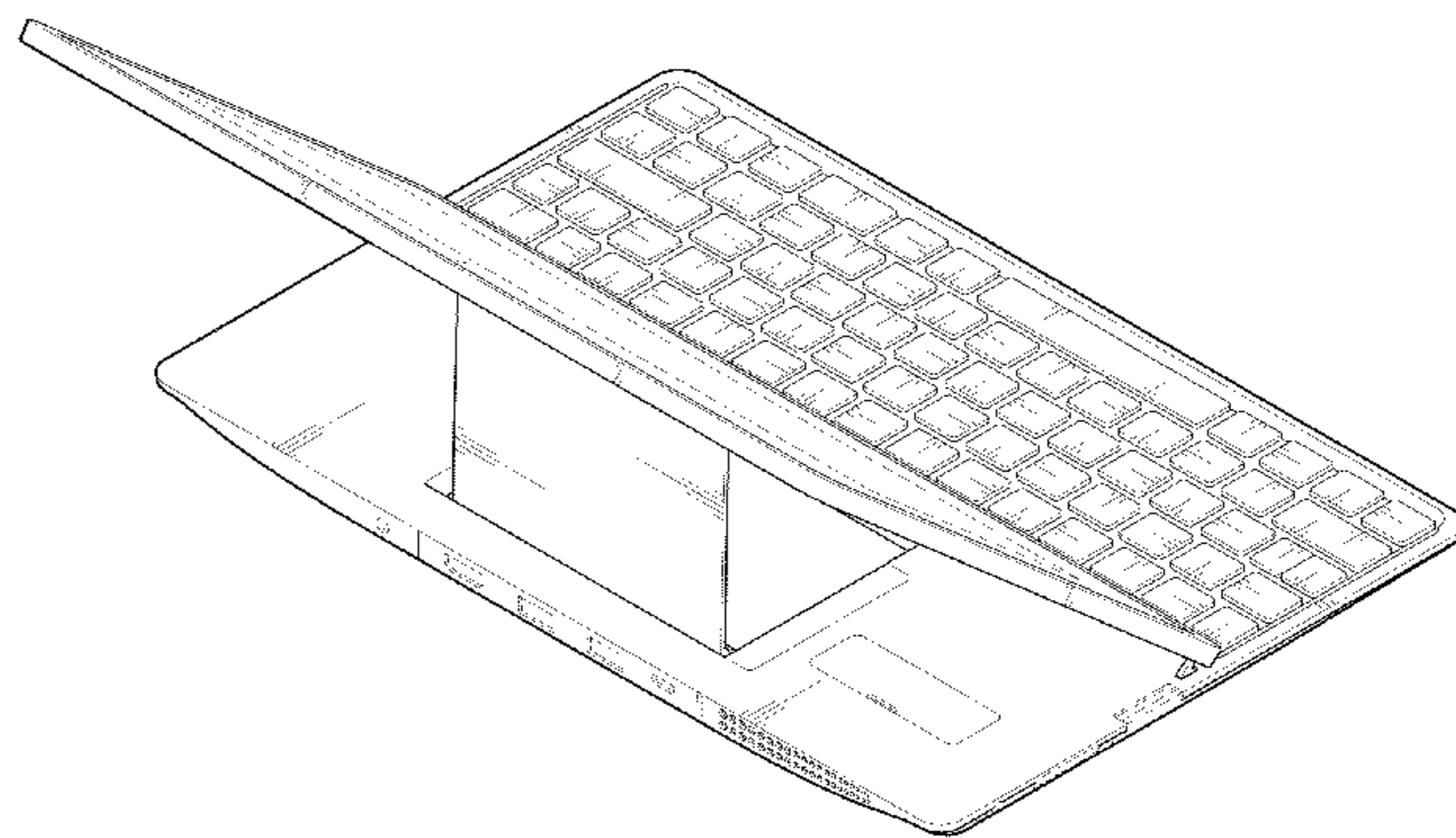
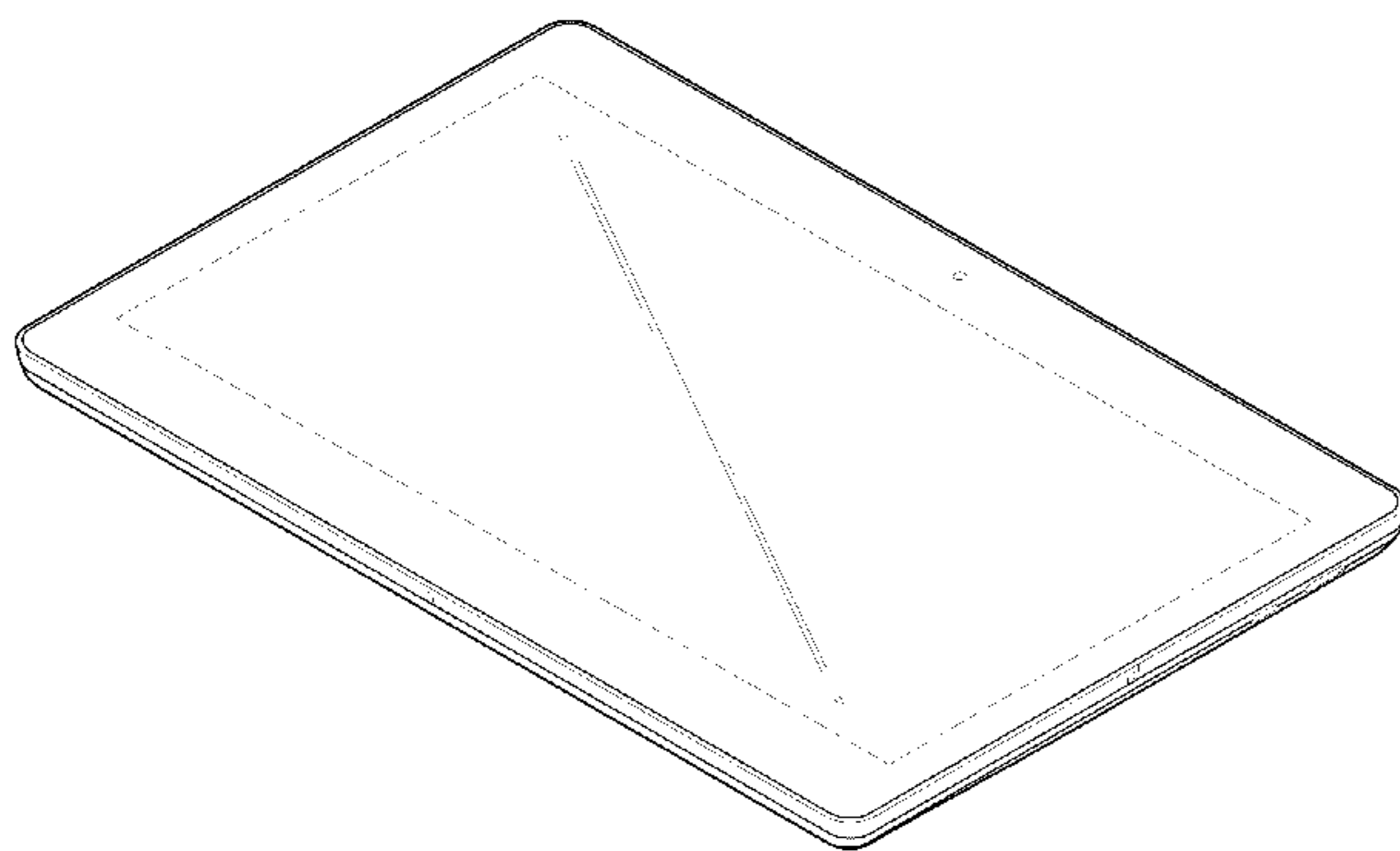

FIG. 1

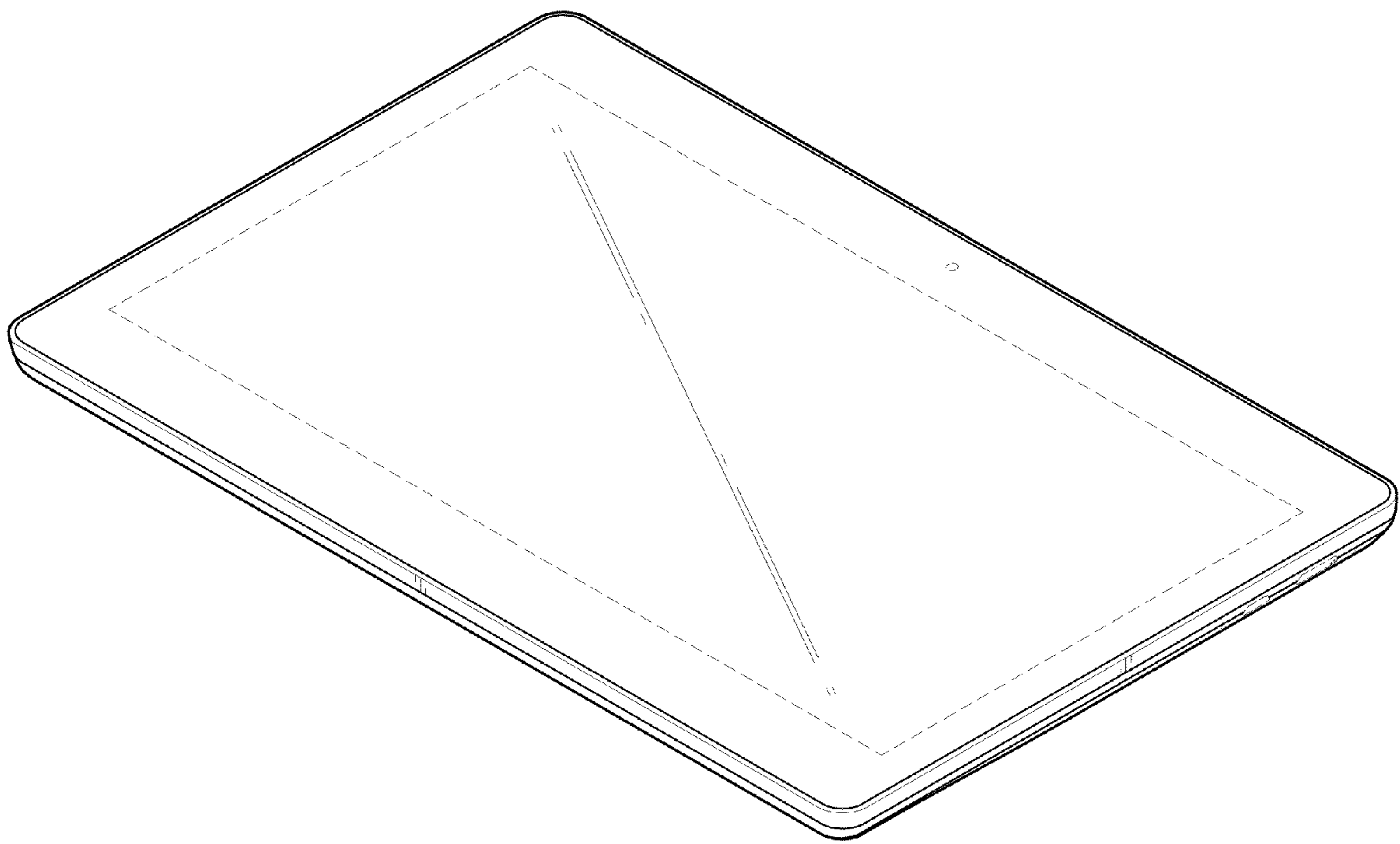

FIG. 2

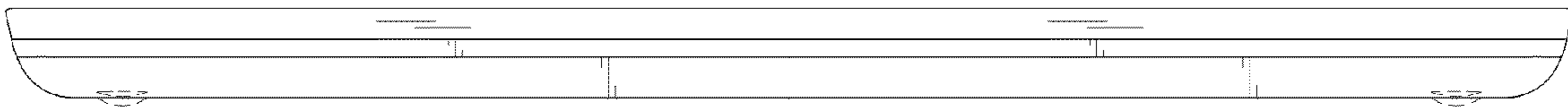

FIG. 3

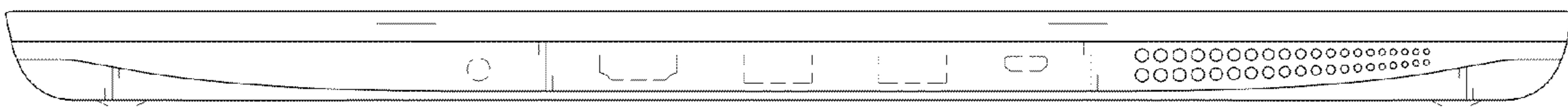

FIG. 4

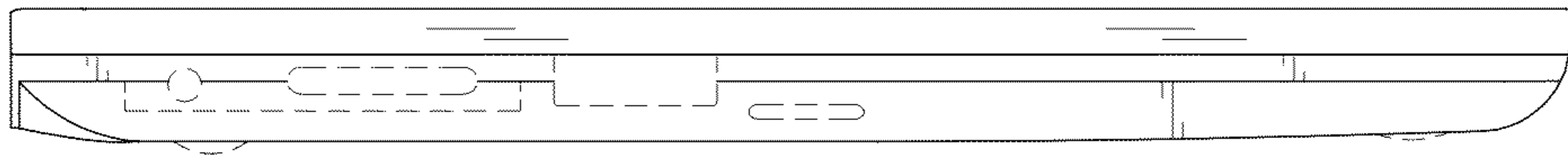

FIG. 5

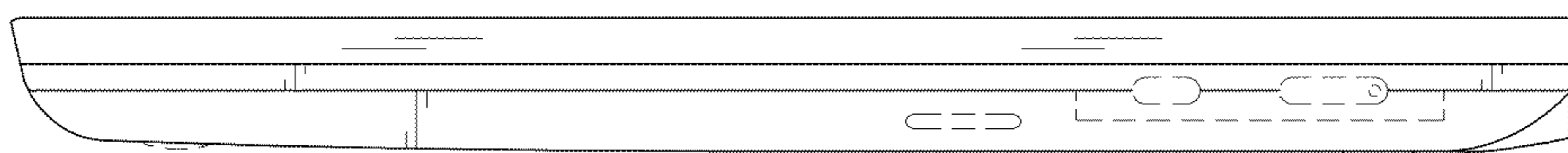

FIG. 6

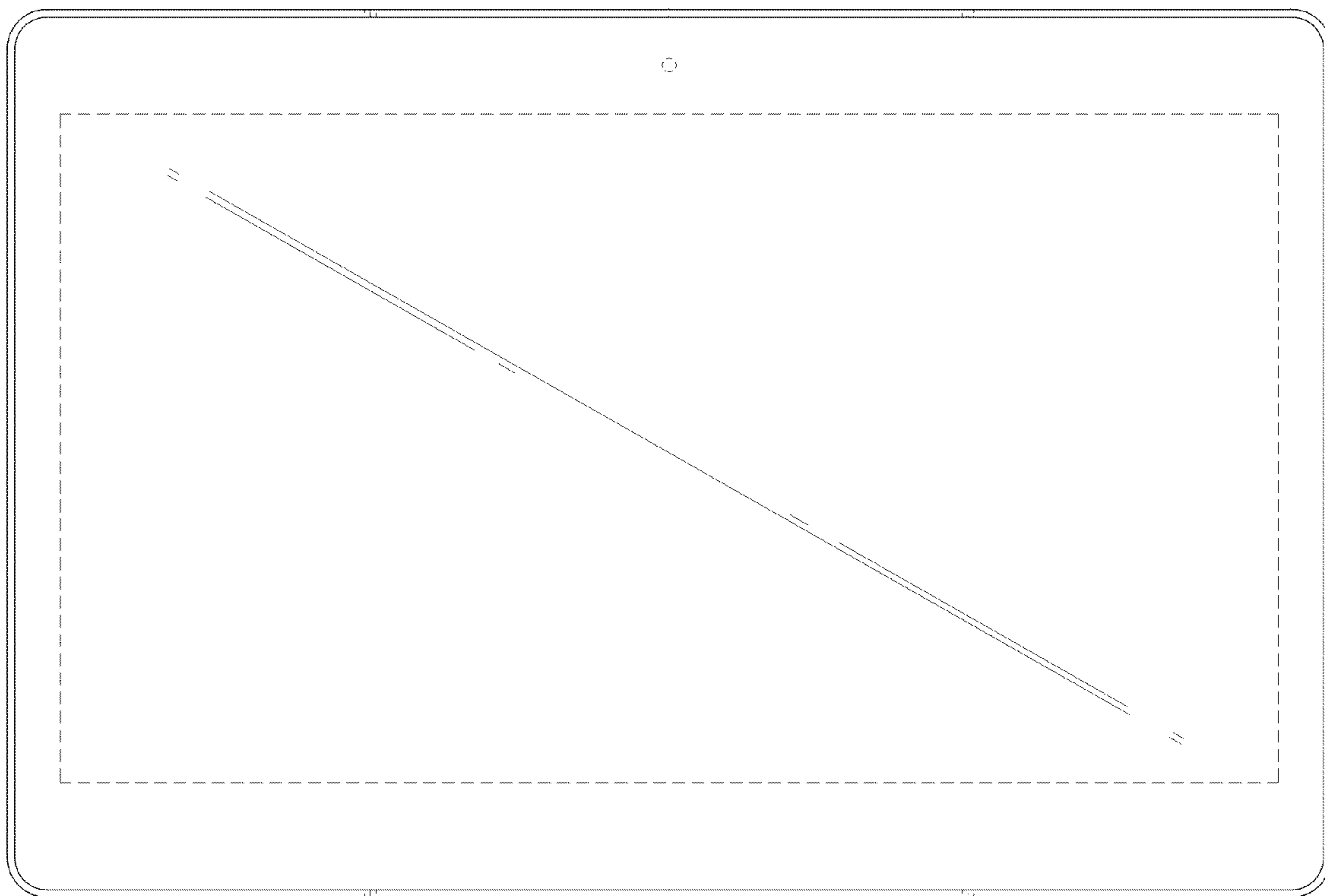

FIG. 7

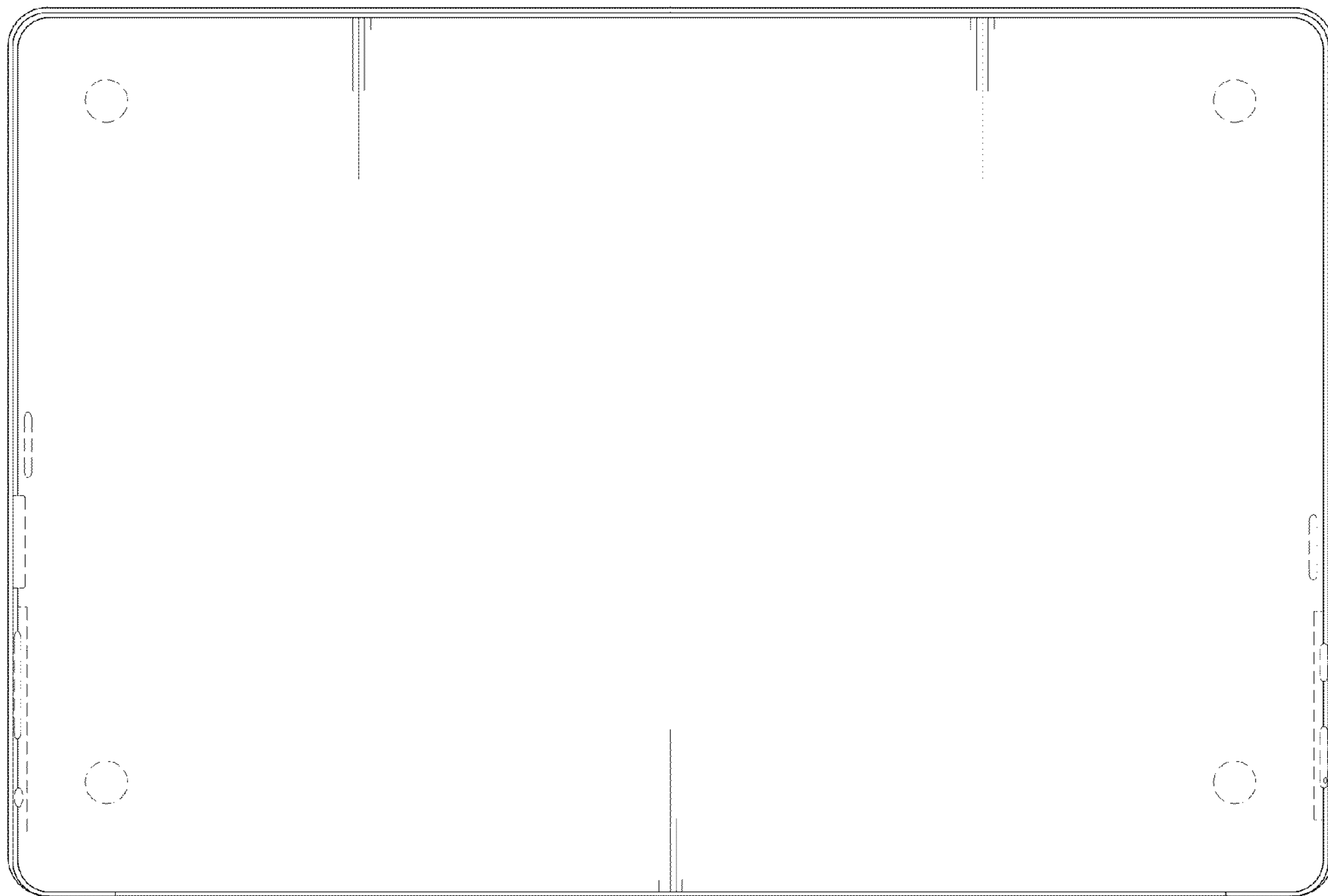

FIG. 8

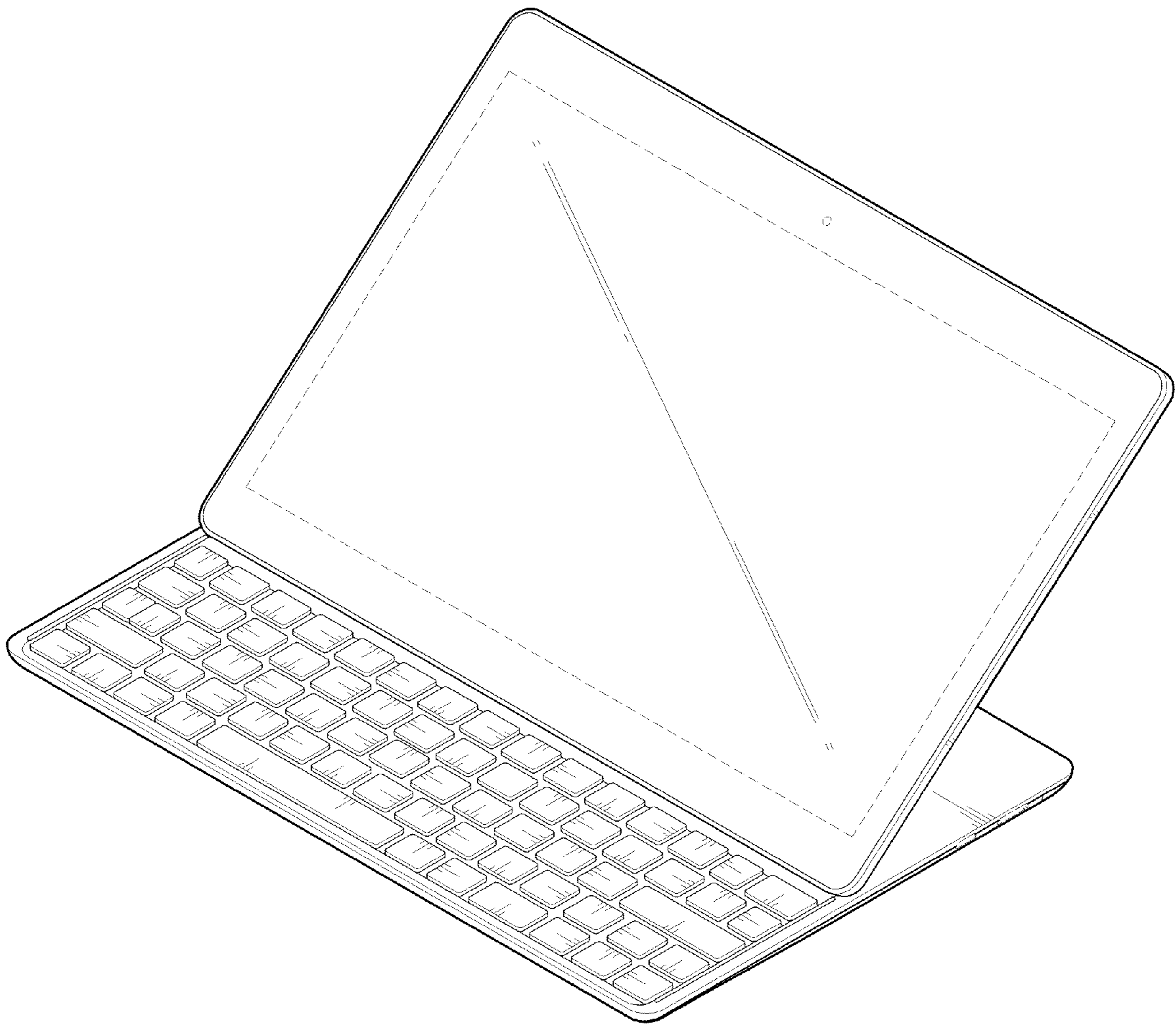

FIG. 9

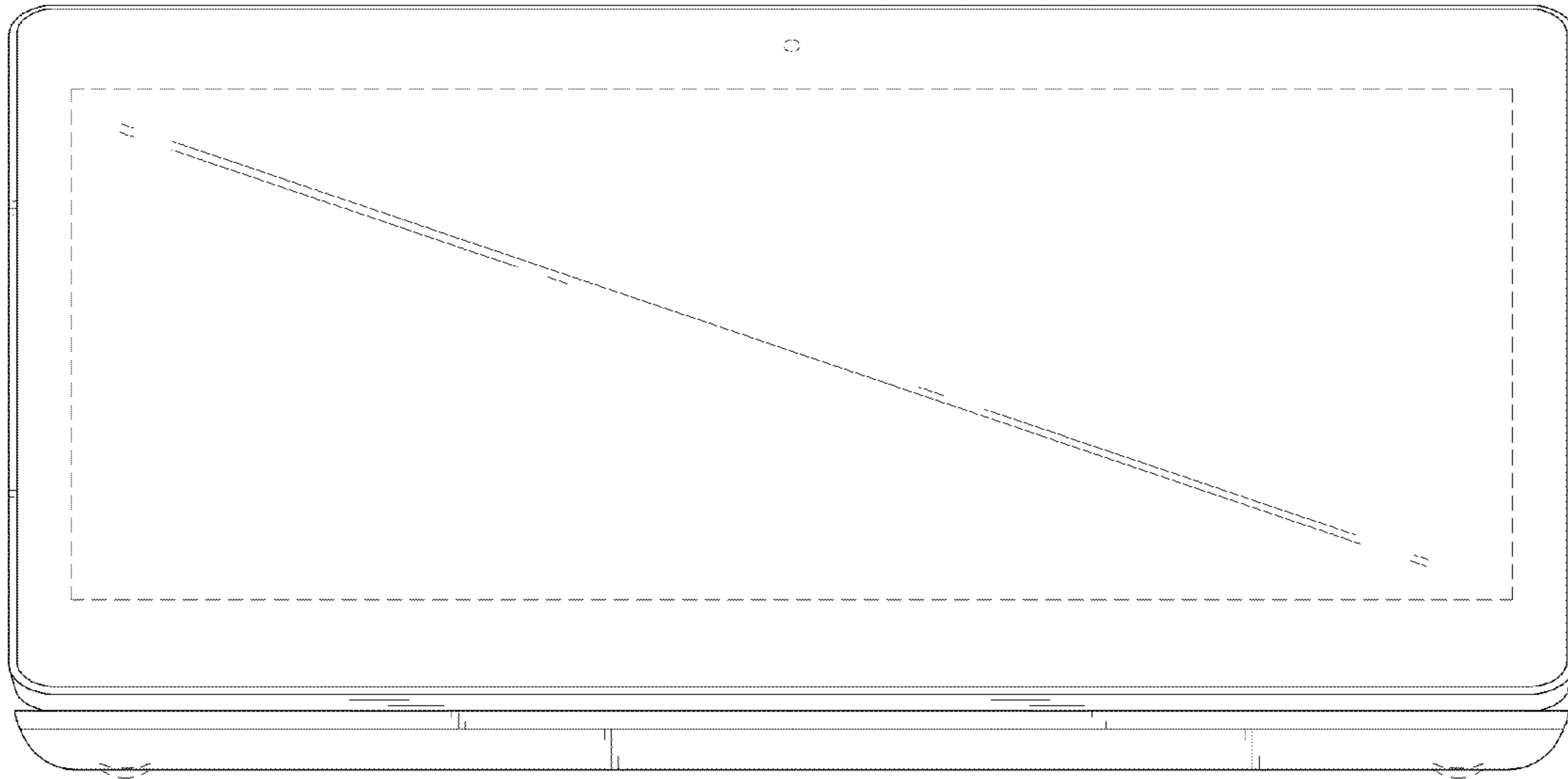

FIG. 10

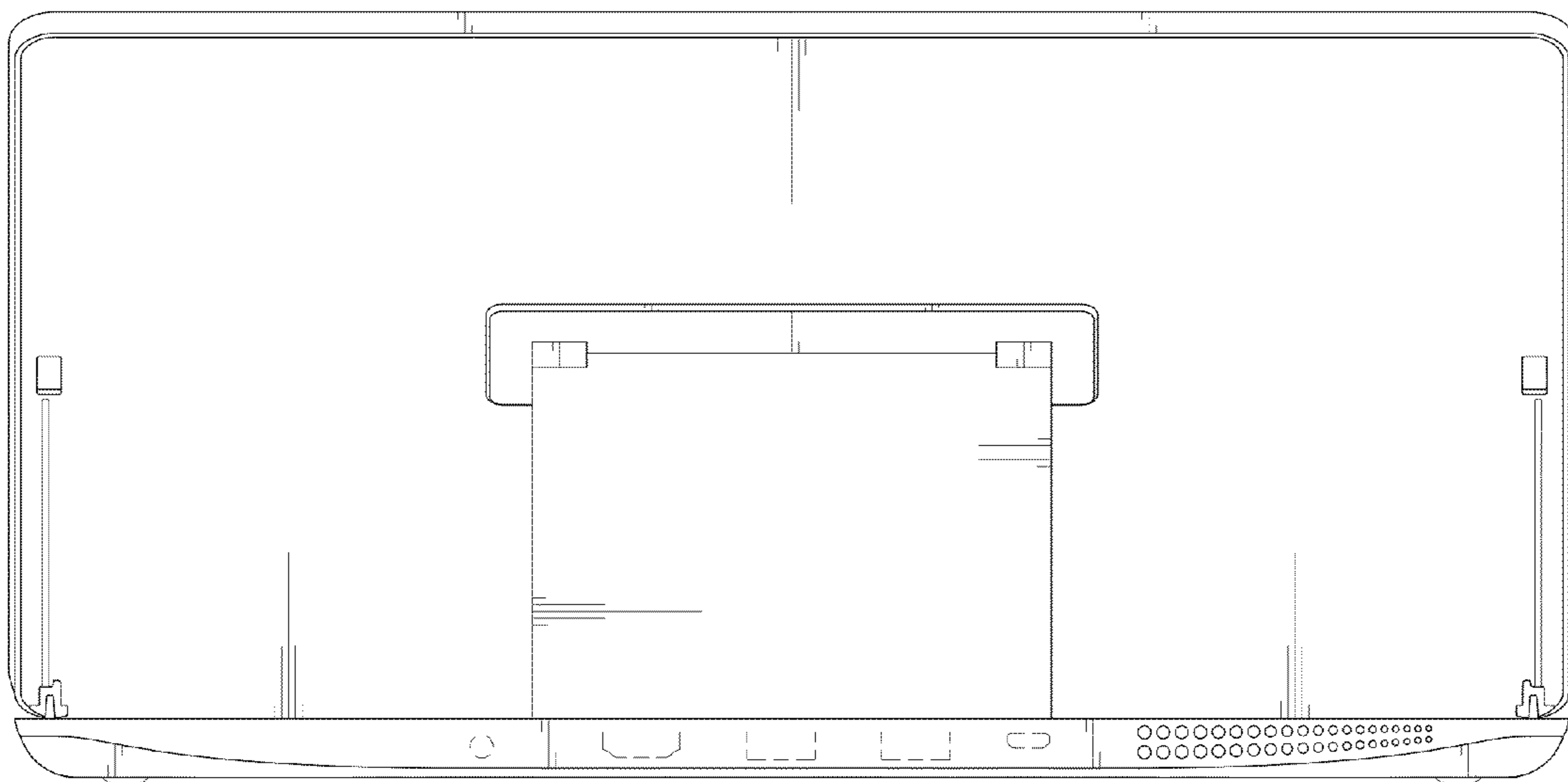

FIG. 11

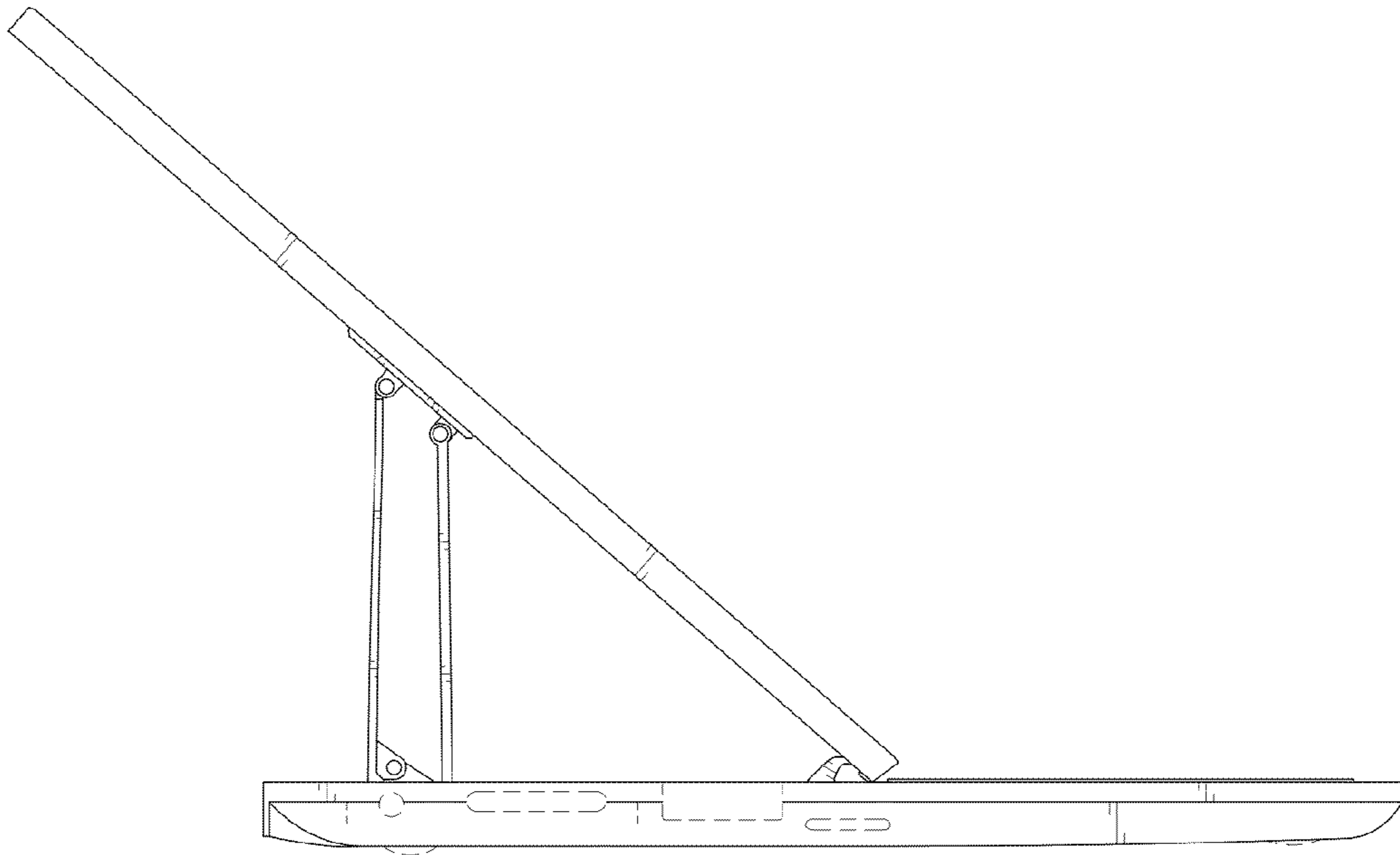

FIG. 12

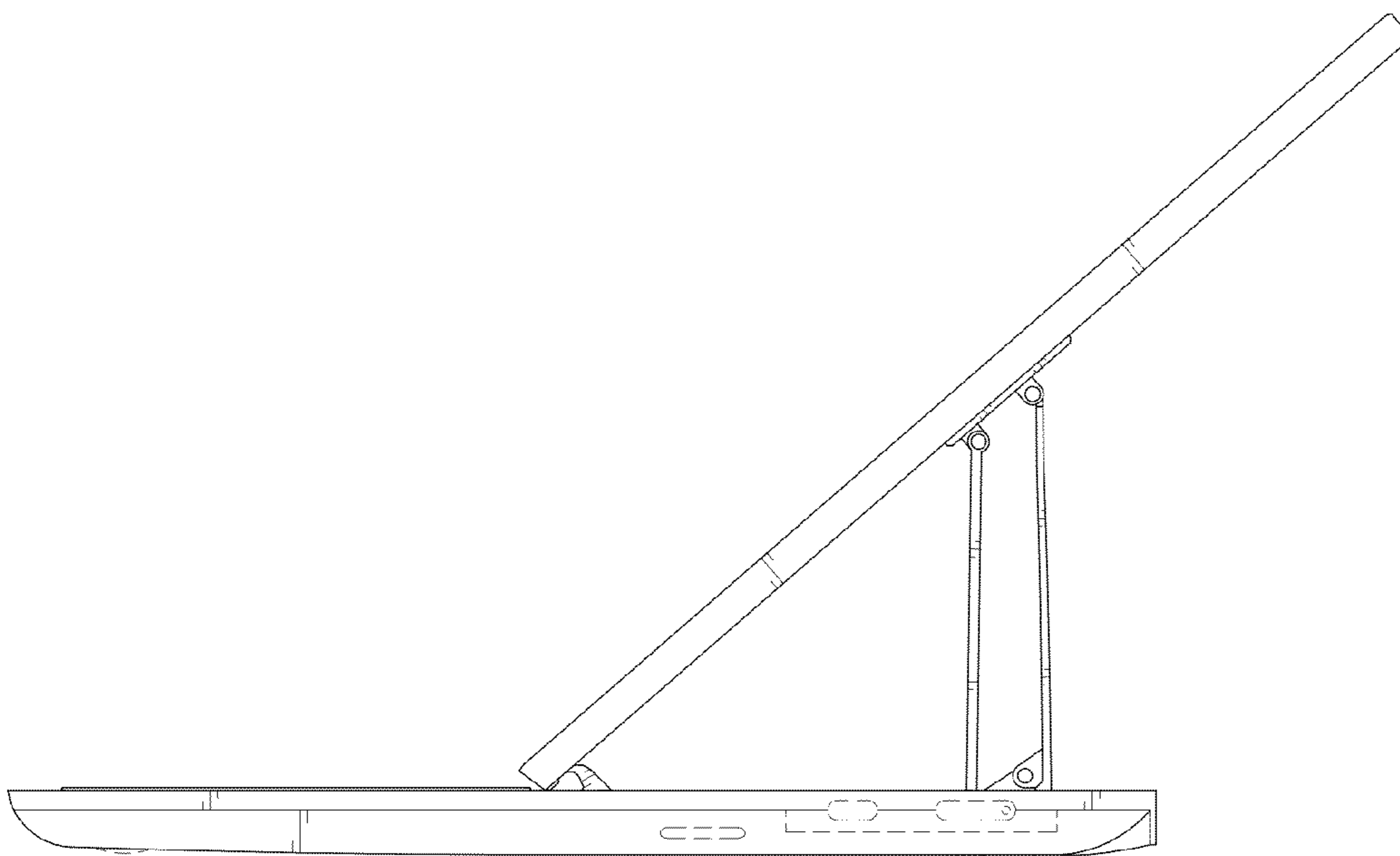

FIG. 13

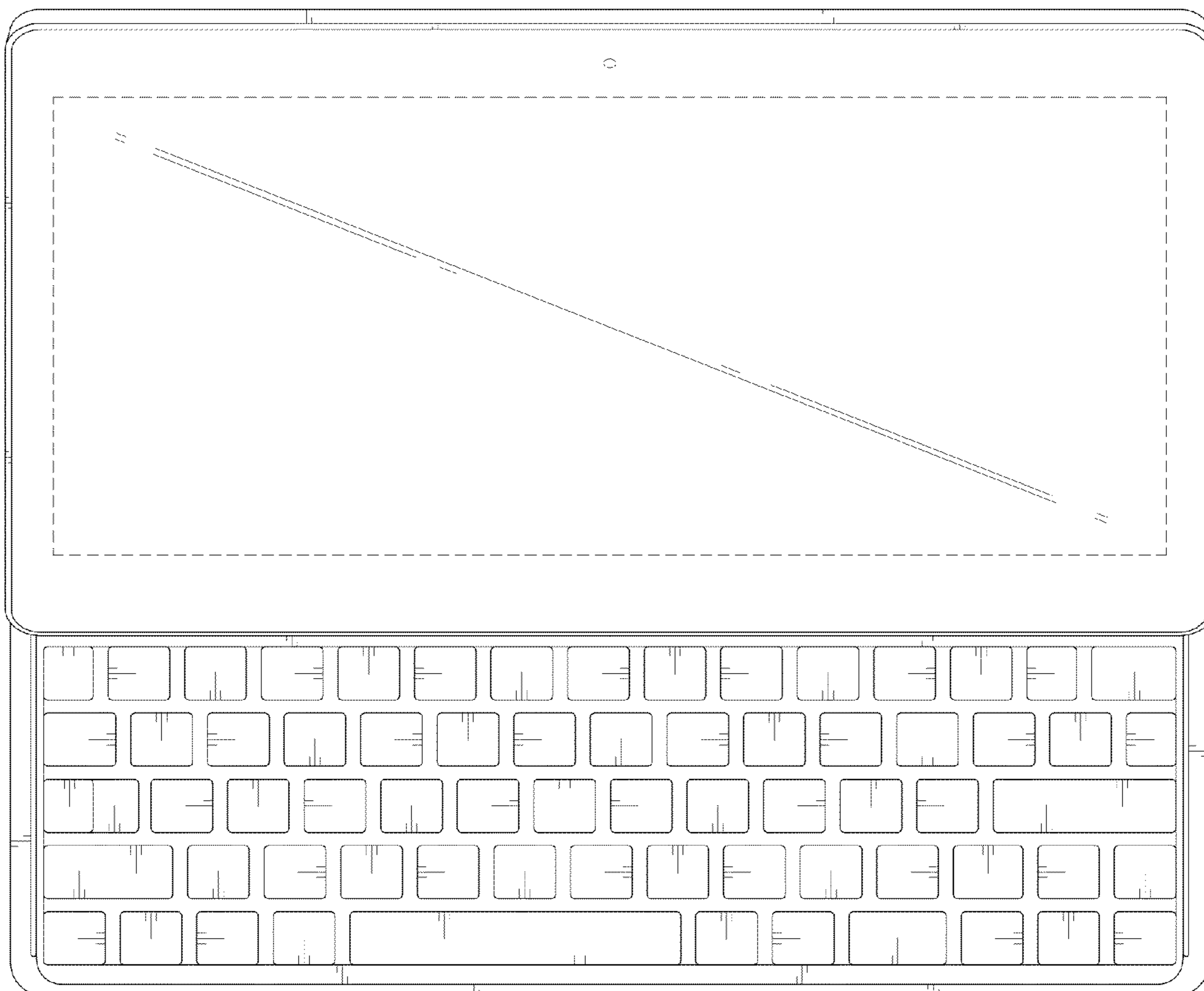

FIG. 14



FIG. 15

