



US00D726702S

(12) **United States Design Patent**
Umlauf

(10) **Patent No.:** **US D726,702 S**
(45) **Date of Patent:** **** Apr. 14, 2015**

(54) **ELECTRONIC DEVICE HOLDER WITH
REMOVABLE BACK**

(71) Applicant: **Ann Umlauf**, Littleton, CO (US)

(72) Inventor: **Ann Umlauf**, Littleton, CO (US)

(73) Assignee: **Switchback, Ltd**, Boulder, CO (US)

(**) Term: **14 Years**

(21) Appl. No.: **29/456,508**

(22) Filed: **May 31, 2013**

(51) **LOC (10) Cl.** **14-03**

(52) **U.S. Cl.**
USPC **D14/250**

(58) **Field of Classification Search**
USPC D14/250, 138 AA, 138 AB, 138 AD,
D14/138 G, 217, 238.1, 248, 251-253, 346,
D14/356, 440, 496, 203.5, 203.8; D13/103,
D13/107, 108; D3/201, 218, 247, 269, 273,
D3/301, 303; 455/575.1, 575.8; 206/305,
206/320, 251, 45.2

See application file for complete search history.

(56) **References Cited**

U.S. PATENT DOCUMENTS

D580,387 S	11/2008	Andre et al.	
D618,678 S	6/2010	Andre et al.	
D634,319 S	3/2011	Andre et al.	
D673,554 S *	1/2013	Simmer	D14/250
D678,871 S *	3/2013	Mishan et al.	D14/250
D685,779 S *	7/2013	Schriefer et al.	D14/250
D687,027 S *	7/2013	Melanson et al.	D14/250
8,517,172 B1 *	8/2013	Chang	206/320
D691,122 S *	10/2013	Bau	D14/250
D694,222 S *	11/2013	Thompson et al.	D14/238.1
D694,226 S *	11/2013	Thompson et al.	D14/250
D697,504 S *	1/2014	Yang	D14/250
D699,757 S *	2/2014	Wilkey	D14/496
D700,598 S *	3/2014	Kim	D14/250
D702,672 S *	4/2014	Mather	D14/250

(Continued)

Primary Examiner — Barbara Fox

Assistant Examiner — Lilyana Bekic

(74) *Attorney, Agent, or Firm* — Heslin Rothenberg Farley & Mesiti P.C.; Victor A. Cardona, Esq.

(57) **CLAIM**

The design for the electronic device holder with removable back, as shown and described.

DESCRIPTION

FIG. 1 is an exploded front perspective view of an electronic device holder with removable back in accordance with the new design;

FIG. 2 is an exploded rear perspective view thereof;

FIG. 3 is a rear perspective view thereof;

FIG. 4 is a front elevational view thereof;

FIG. 5 is a top elevational view thereof;

FIG. 6 is a left side elevational view thereof;

FIG. 7 is a right side elevational view thereof;

FIG. 8 is a bottom elevational view thereof;

FIG. 9 is a rear elevational view thereof;

FIG. 10 is a front elevational view of the front portion of the electronic device holder with removable back in accordance with the new design;

FIG. 11 is a top elevational view thereof;

FIG. 12 is a left side elevational view thereof;

FIG. 13 is a right side elevational view thereof;

FIG. 14 is a bottom side elevational view thereof;

FIG. 15 is a rear side elevational view thereof;

FIG. 16 is a front elevational view of the back portion of the electronic device holder with removable back in accordance with the new design;

FIG. 17 is a top elevational view thereof;

FIG. 18 is a left side elevational view thereof;

FIG. 19 is a right side elevational view thereof;

FIG. 20 is a bottom side elevational view thereof; and,

FIG. 21 is rear side elevational view thereof.

The broken lines in the drawings illustrate portions of the electronic device holder with removable back which form no part of the claimed design.

1 Claim, 9 Drawing Sheets

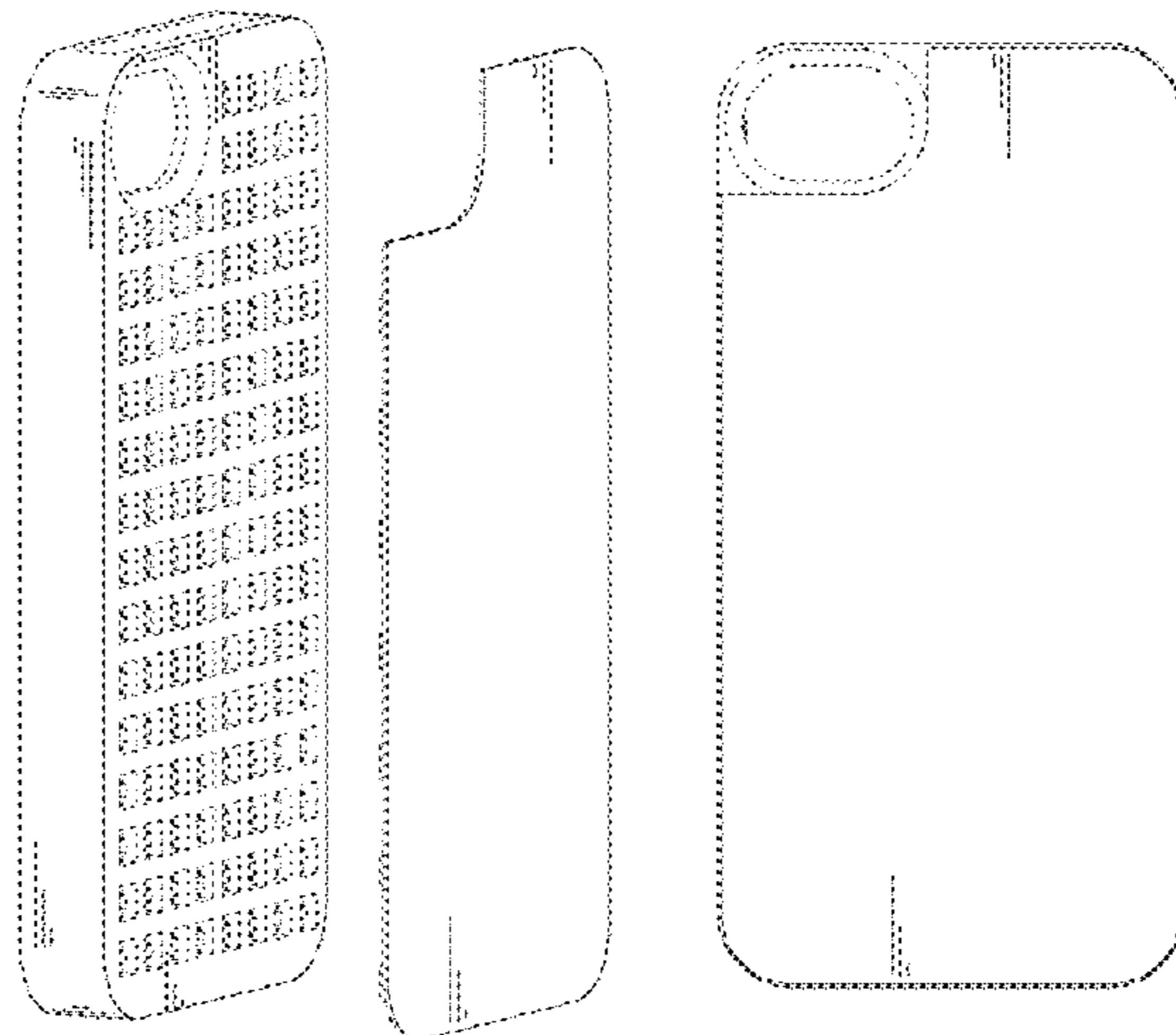

(56)

References Cited

U.S. PATENT DOCUMENTS

D712,892 S *	9/2014	Hong et al.	D14/250	2012/0274195 A1 *	11/2012	Thompson et al.	312/237
D713,833 S *	9/2014	Wilkey	D14/250	2013/0069499 A1 *	3/2013	Modrell	312/223.1
2012/0217257 A1 *	8/2012	Ting	220/660	2014/0037897 A1 *	2/2014	Wyner	428/138
2012/0261289 A1 *	10/2012	Wyner et al.	206/320	2014/0045557 A1 *	2/2014	Chung	455/575.1
					2014/0116897 A1 *	5/2014	Wilkey	206/37
					2014/0194167 A1 *	7/2014	Grimes	455/575.1
					2014/0274232 A1 *	9/2014	Tages	455/575.8

* cited by examiner

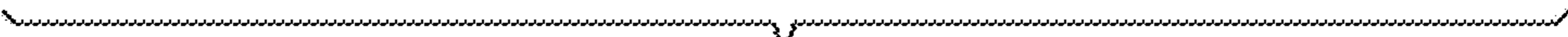
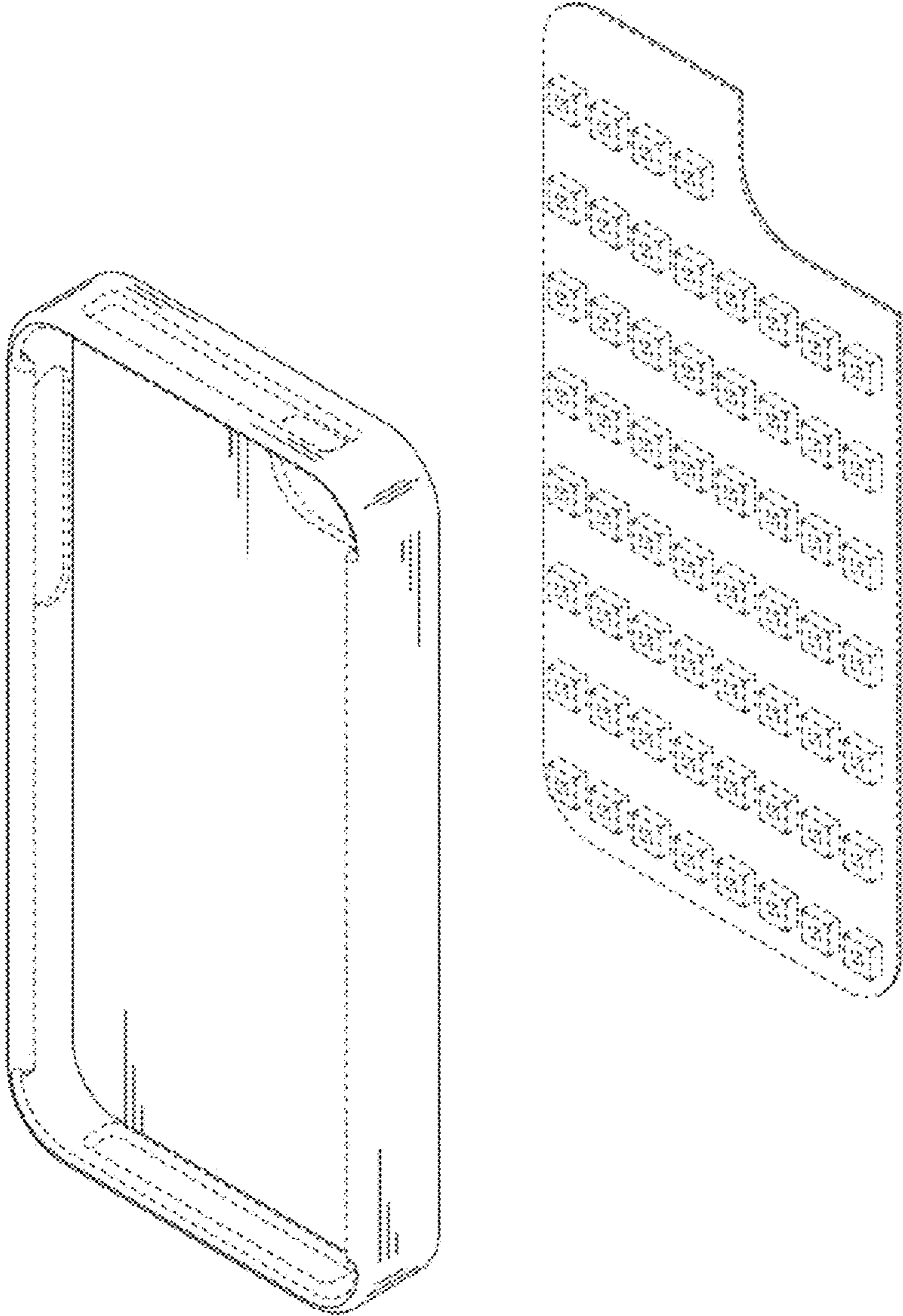

FIG. 1

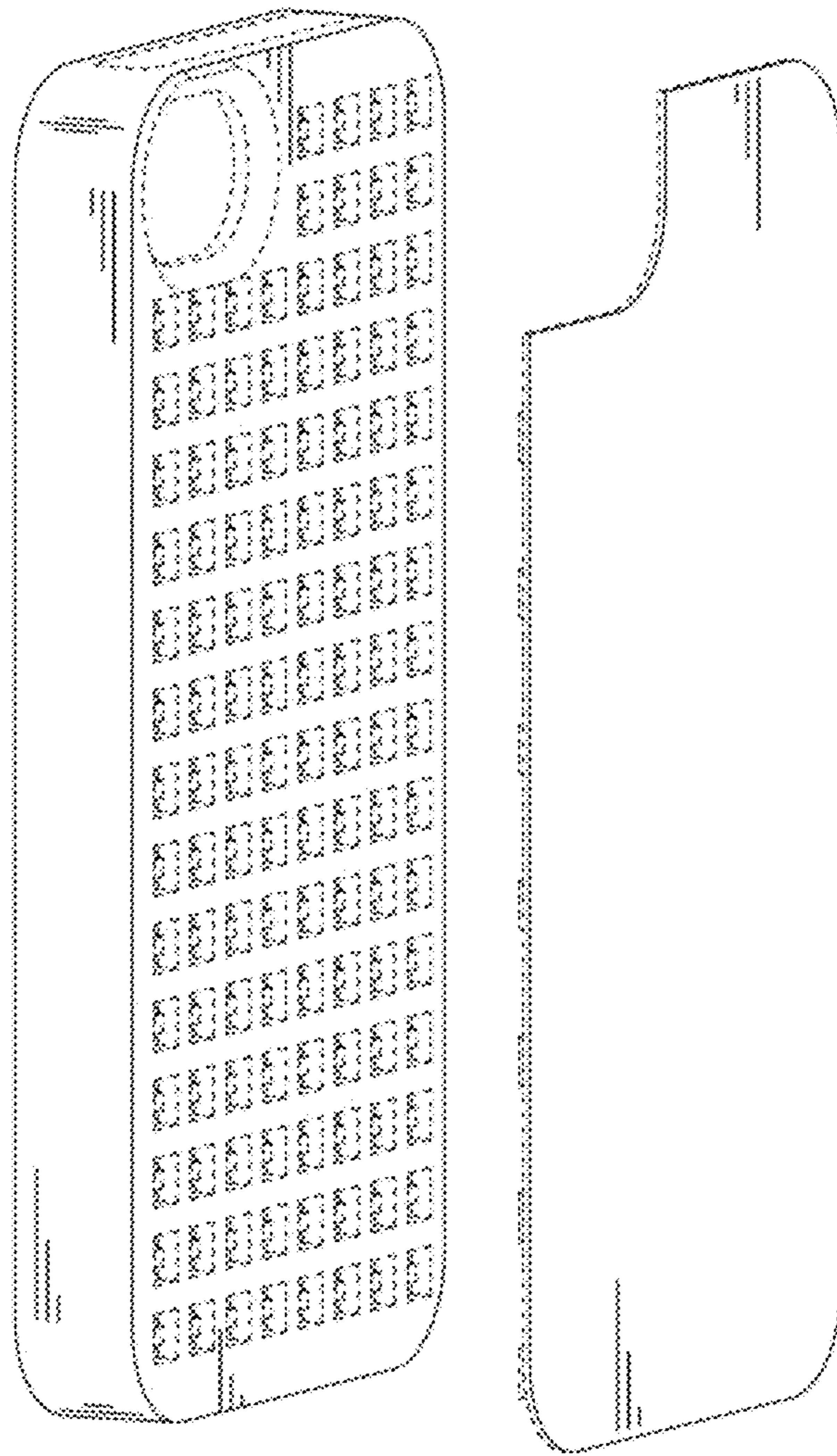

FIG. 2

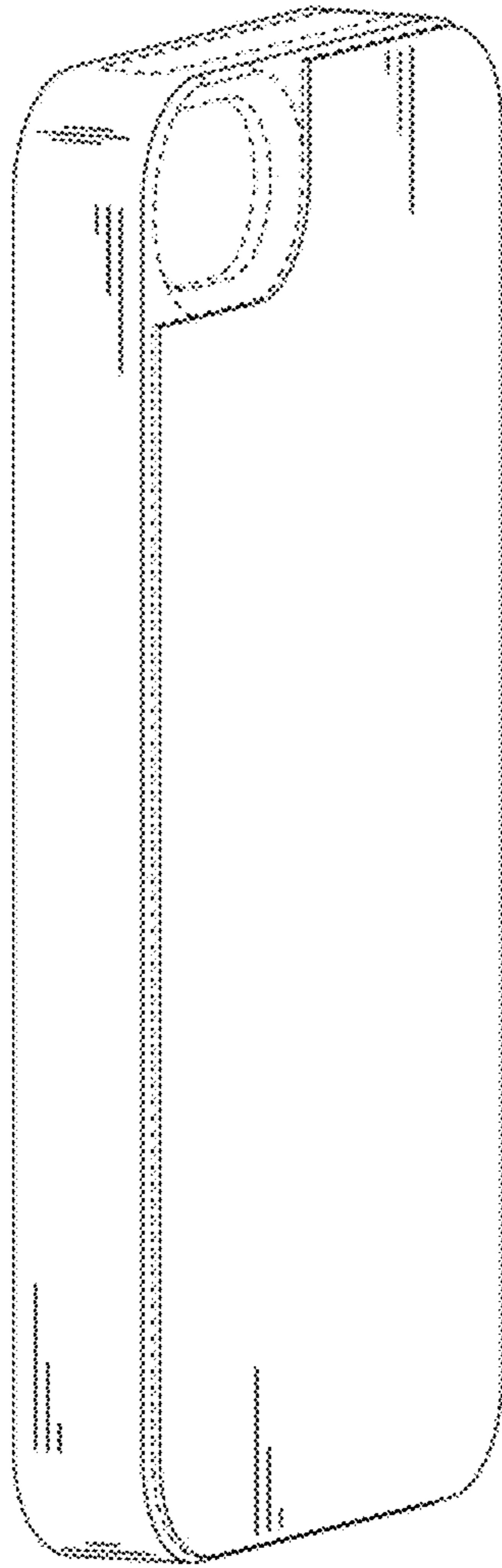

FIG. 3

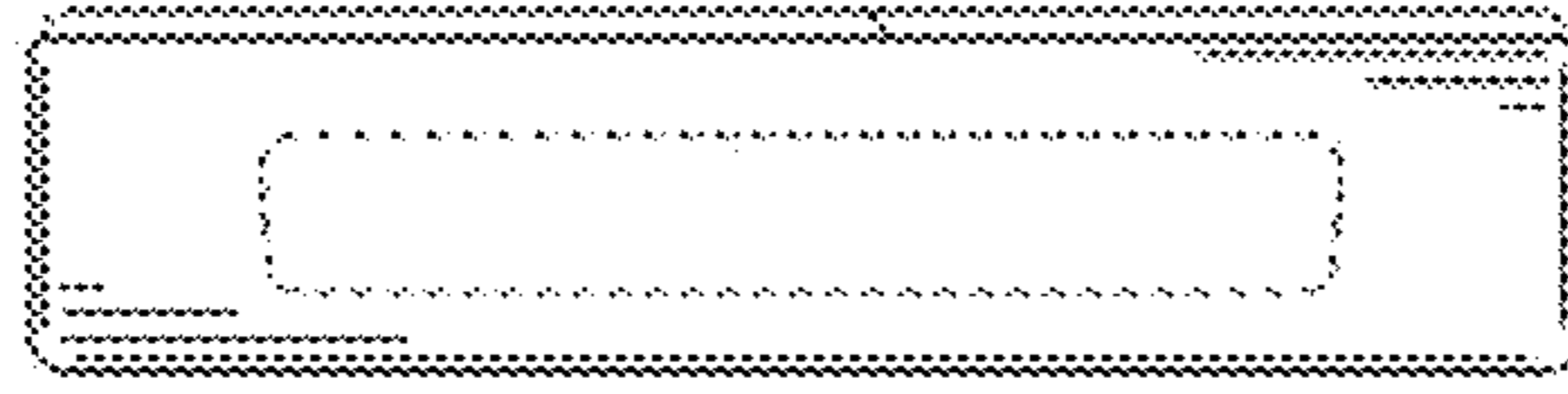

FIG. 5

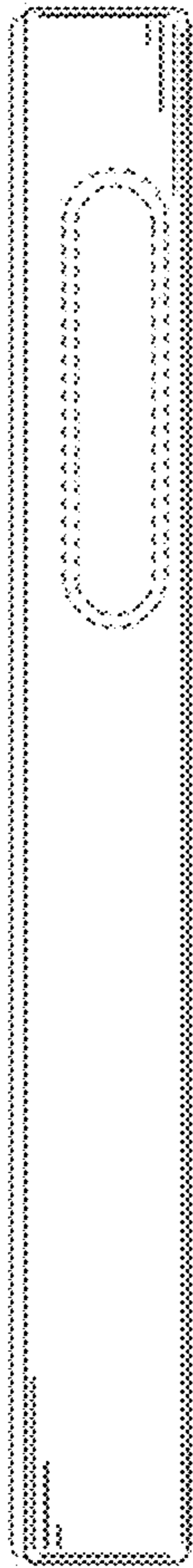

FIG. 6

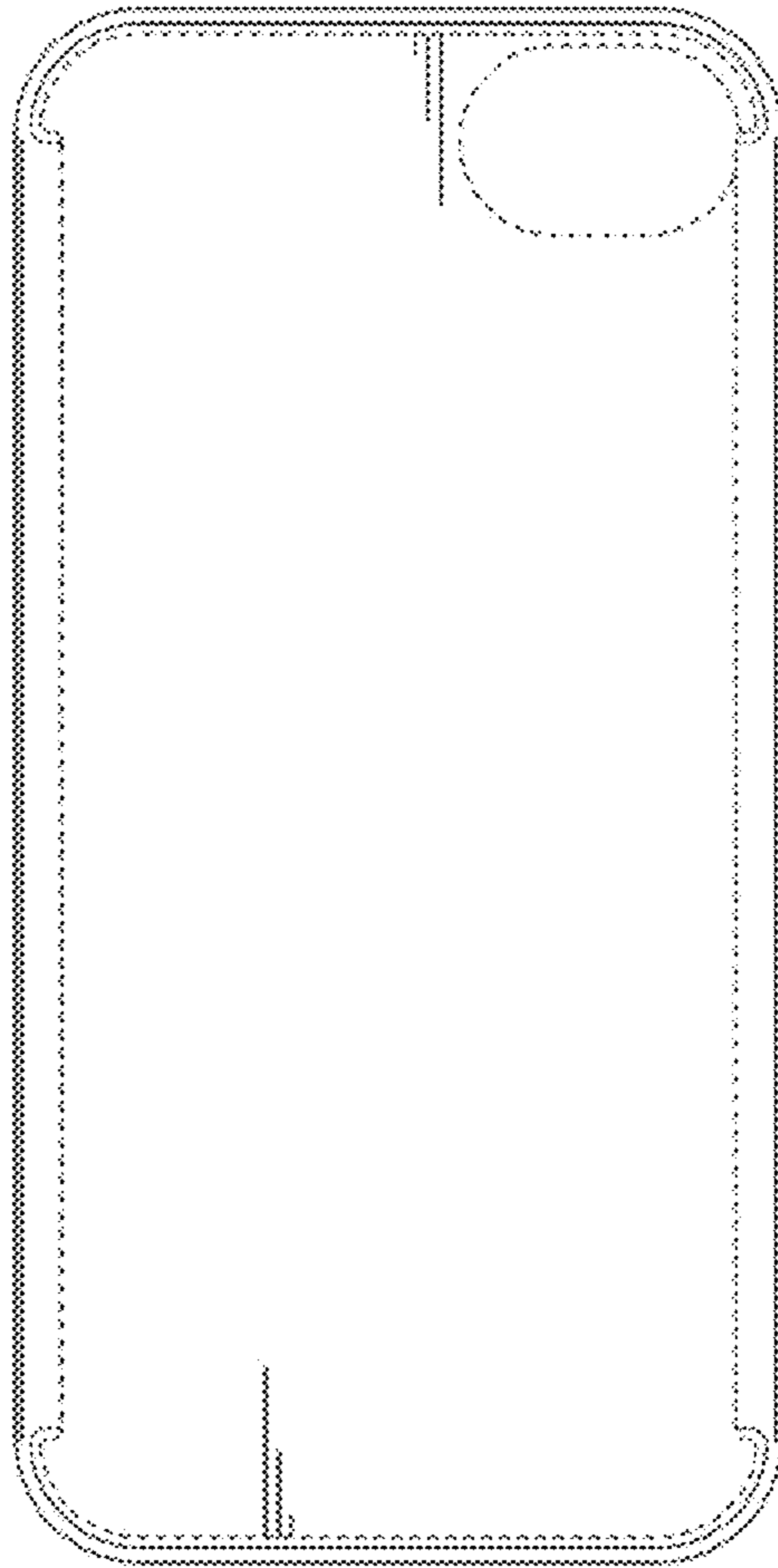

FIG. 4

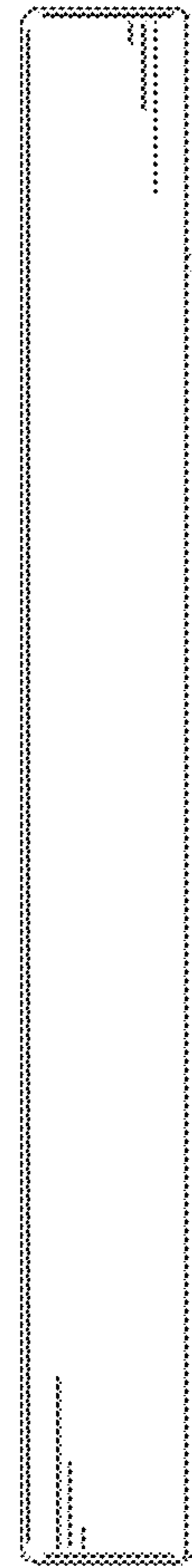

FIG. 7

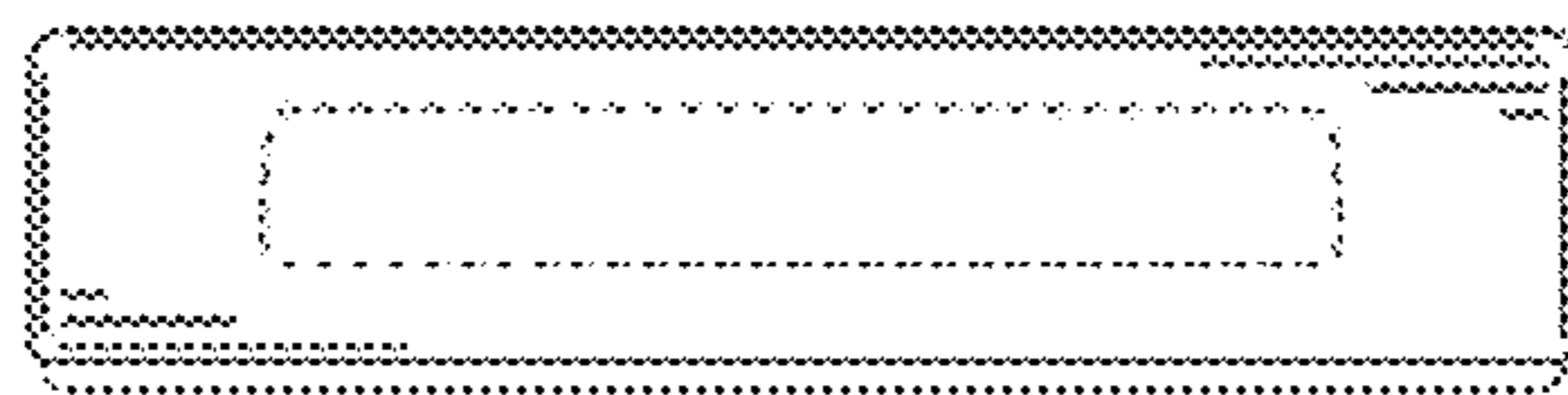

FIG. 8

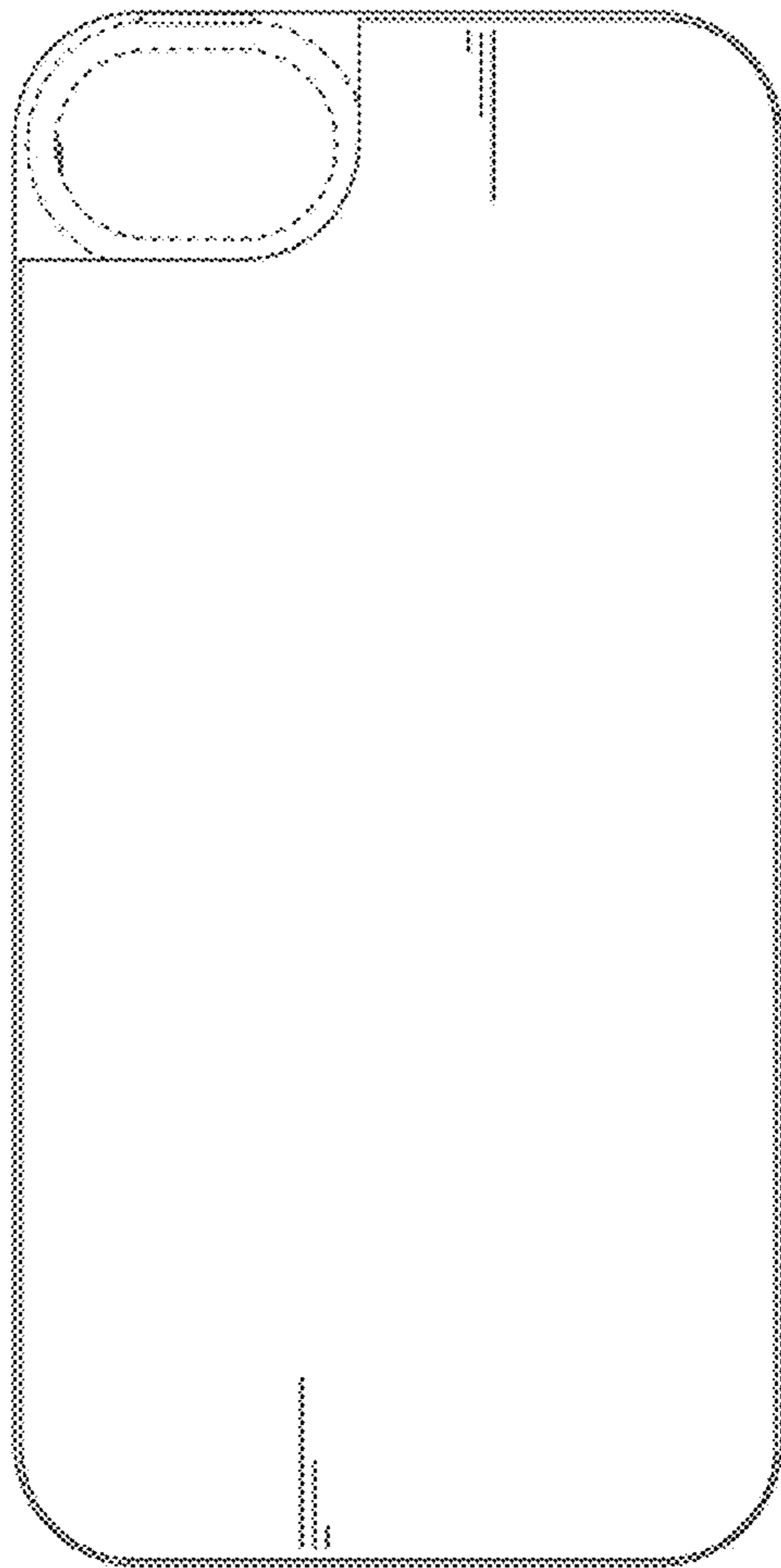

FIG. 9

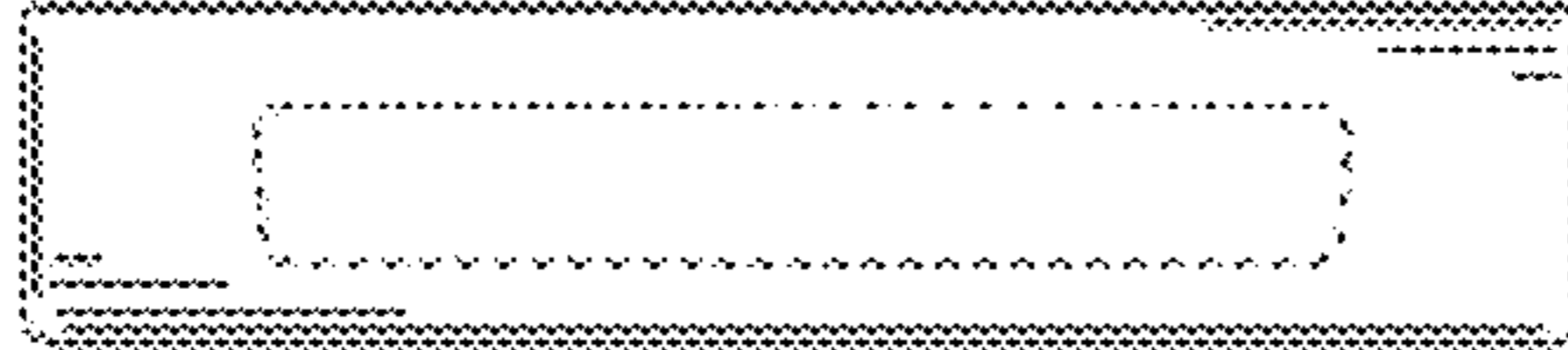

FIG. 11

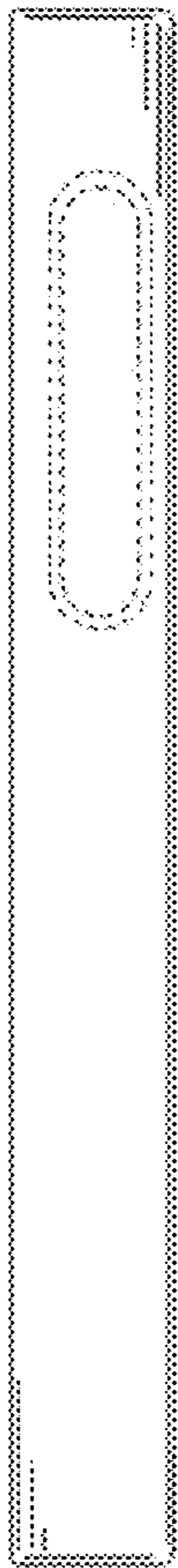

FIG. 12

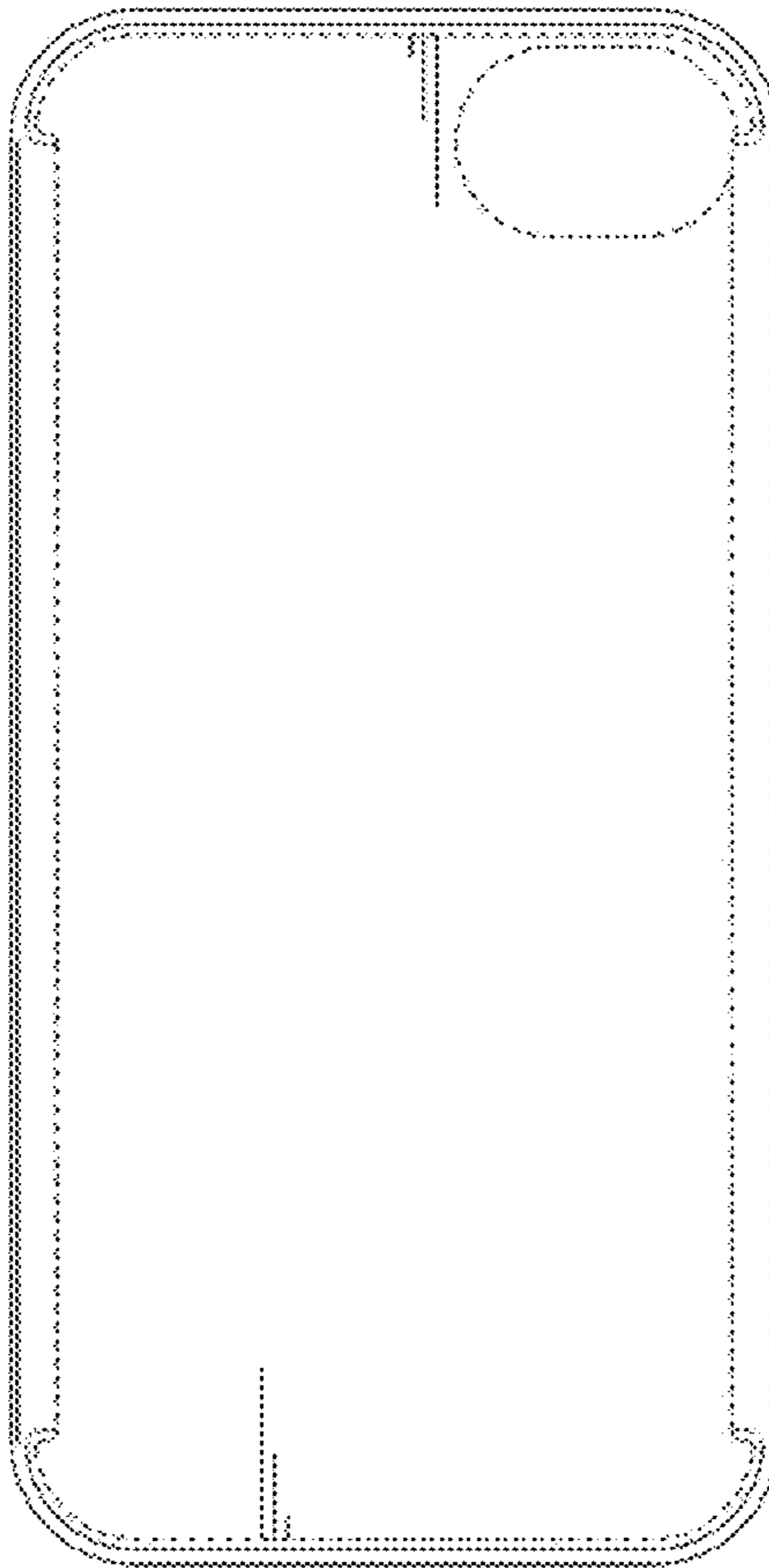

FIG. 10

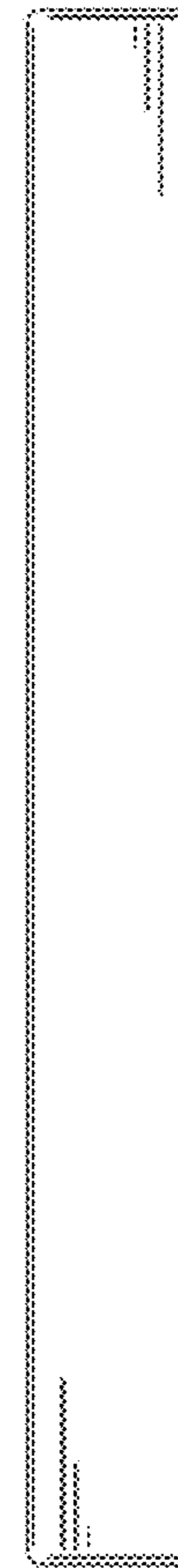

FIG. 13

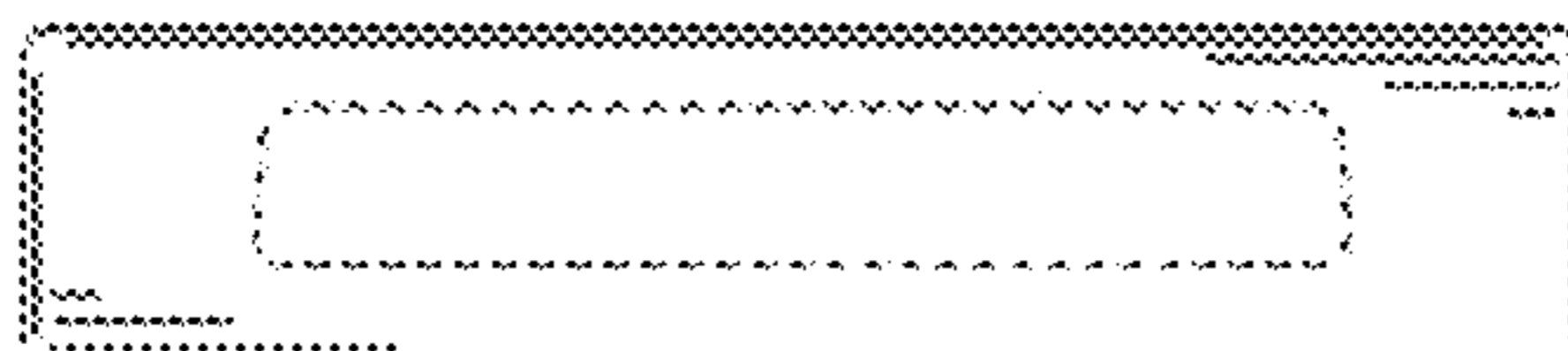

FIG. 14

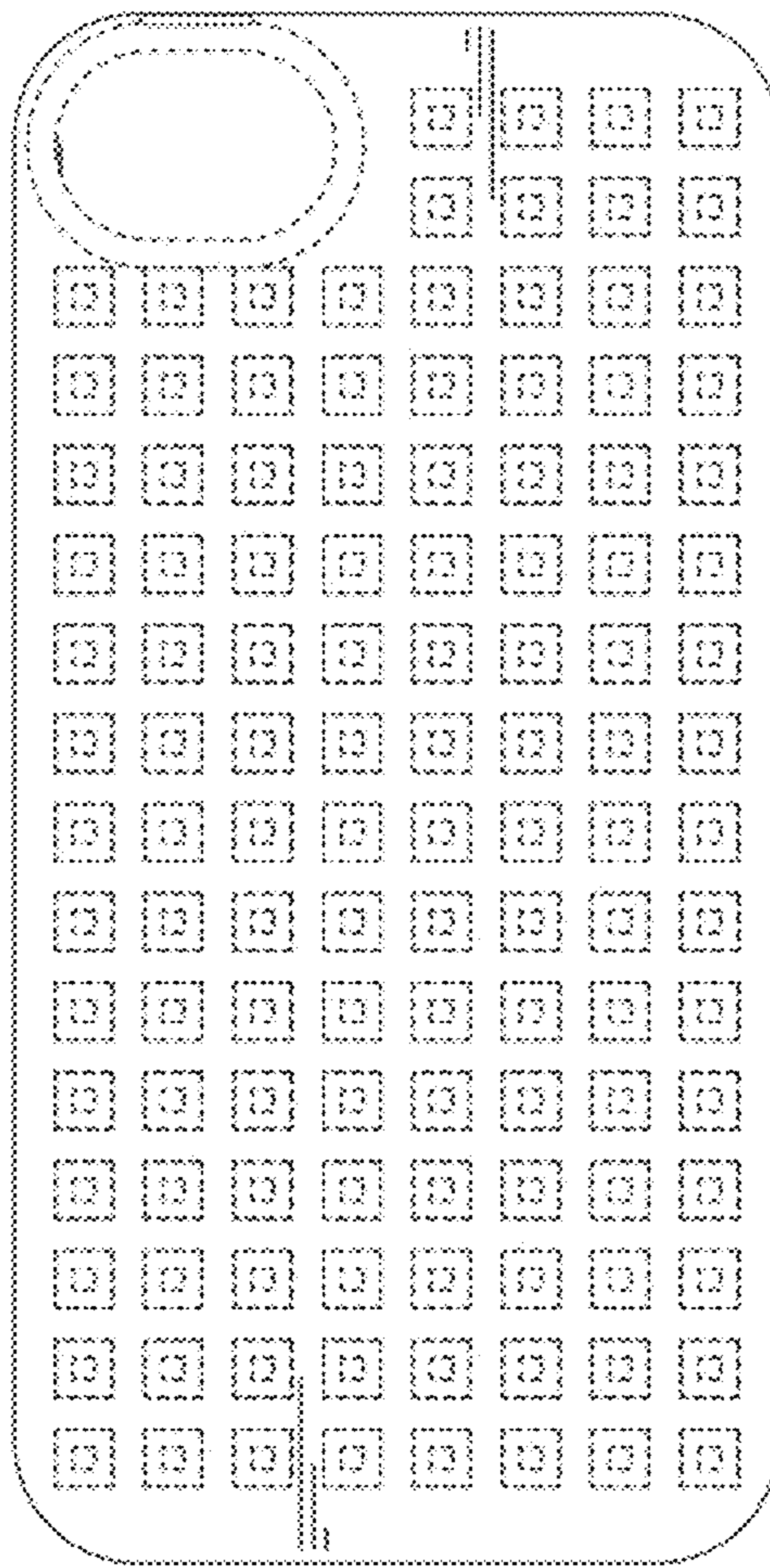

FIG. 15

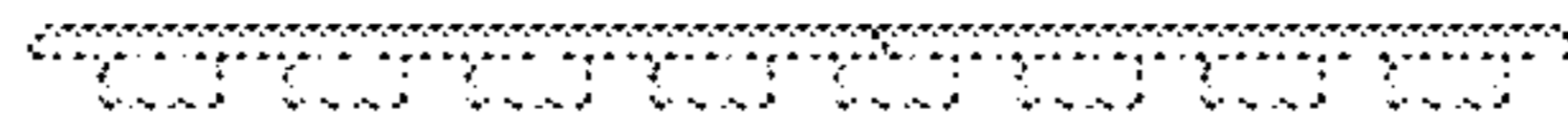

FIG. 17

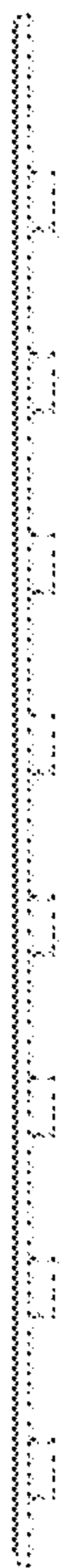

FIG. 18

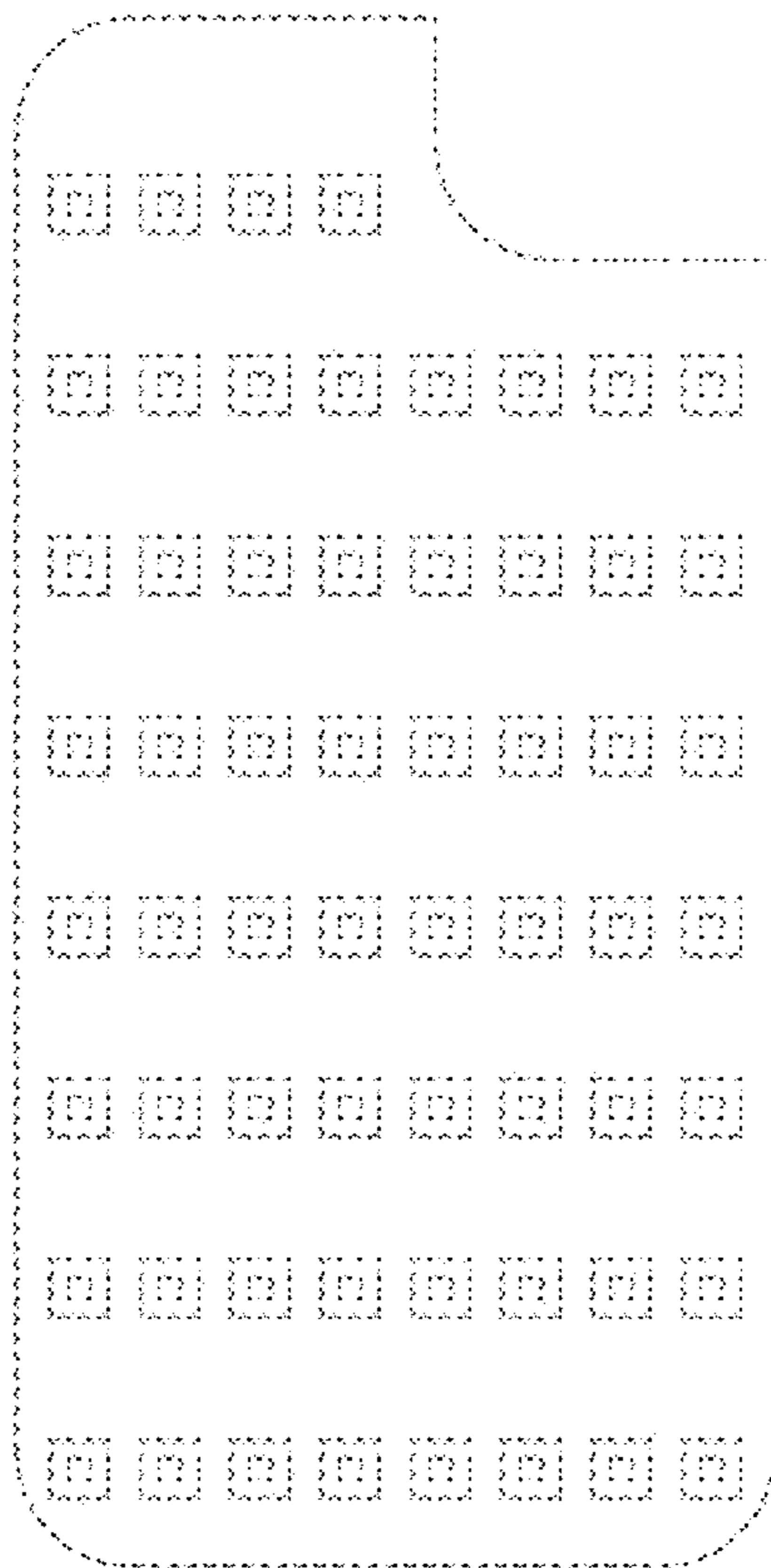

FIG. 16



FIG. 19

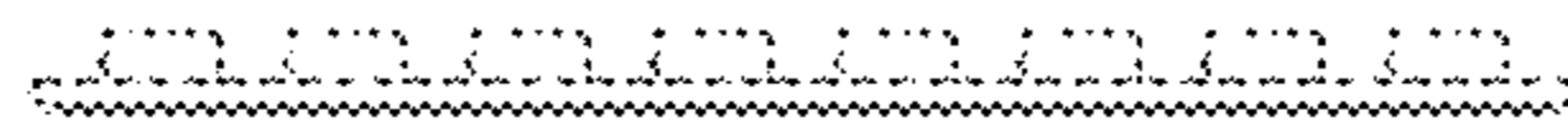

FIG. 20

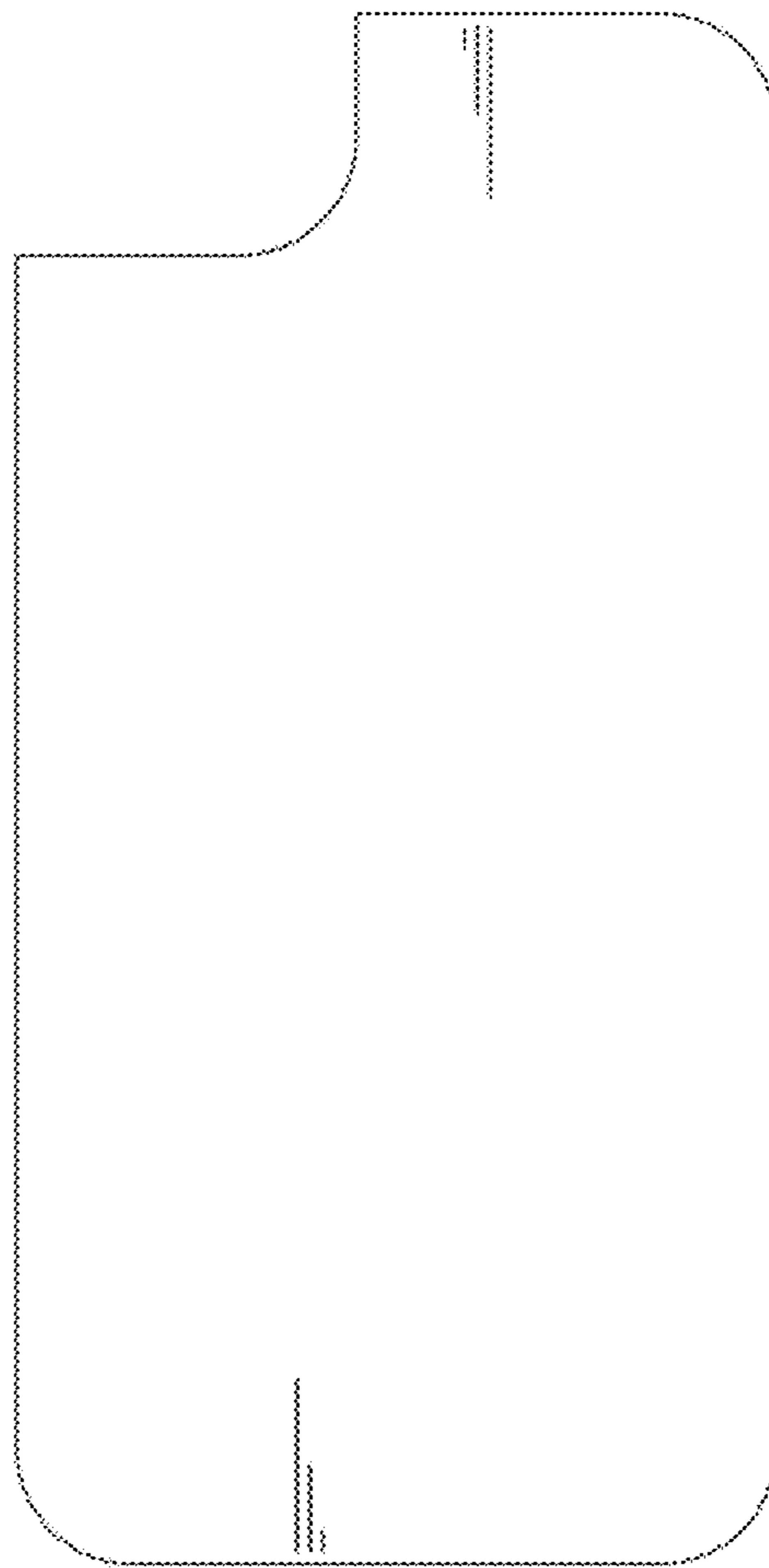

FIG. 21

UNITED STATES PATENT AND TRADEMARK OFFICE
CERTIFICATE OF CORRECTION

PATENT NO. : D726,702 S
APPLICATION NO. : 29/456508
DATED : April 14, 2015
INVENTOR(S) : Ann Umlauf

Page 1 of 1

It is certified that error appears in the above-identified patent and that said Letters Patent is hereby corrected as shown below:

On the title page in the Description item (57): Delete "FIG. 12 is a left side devotional view thereof;"
and insert --FIG. 12 is a left side elevational view thereof--

Signed and Sealed this
Twenty-fifth Day of August, 2015



Michelle K. Lee
Director of the United States Patent and Trademark Office