



US00D726679S

(12) **United States Design Patent**  
**Kim et al.**

(10) **Patent No.:** **US D726,679 S**  
(45) **Date of Patent:** **\*\* Apr. 14, 2015**

(54) **MOBILE PHONE**  
(71) Applicant: **LG Electronics Inc.**, Seoul (KR)  
(72) Inventors: **Dongsoon Kim**, Yongin-si (KR);  
**Seongjae Lim**, Seoul (KR)  
(73) Assignee: **LG Electronics Inc.**, Seoul (KR)  
(\*\*) Term: **14 Years**

5,329,501	A	*	7/1994	Meister et al.	368/10
D355,613	S	*	2/1995	Takani et al.	D10/39
D355,615	S	*	2/1995	Atagi	D10/39
D368,229	S	*	3/1996	Crocco	D10/30
5,596,551	A	*	1/1997	Born et al.	368/10
D381,920	S	*	8/1997	Galli	D10/30
D388,000	S	*	12/1997	Molineri	D10/30
D389,070	S	*	1/1998	Galli	D10/30
5,721,713	A	*	2/1998	Bornand	368/10
D391,861	S	*	3/1998	Houlihan et al.	D10/30

(Continued)

(21) Appl. No.: **29/481,286**  
(22) Filed: **Feb. 4, 2014**  
(30) **Foreign Application Priority Data**

Aug. 5, 2013 (KR) ..... 30-2013-0040374

(51) **LOC (10) Cl.** ..... **14-03**

(52) **U.S. Cl.**  
USPC ..... **D14/138 R**; D14/344; D10/38

(58) **Field of Classification Search**  
CPC ..... H04B 1/03; H04B 1/385; G04G 17/083  
USPC ..... D14/140, 137, 138 R, 138 AB, 139, 155,  
D14/191, 192, 203.1, 203.3, 203.4, 203.5,  
D14/203.7, 248, 226, 218, 144, 240, 344,  
D14/440, 341, 346, 448, 450, 496;  
D10/30-39, 70, 65, 78, 104.1, 104.2,  
D10/125; D11/3-5, 12, 19, 25; D13/168;  
D8/354, 366, 402, 499; D3/215;  
D15/199; 381/364, 151; 379/433.1;  
455/575.1, 556.1, 556.2, 558, 575.3,  
455/575.4, 575.6, 90.3; 368/10, 13, 69,  
368/223; D21/329; D24/167

See application file for complete search history.

(56) **References Cited**

**U.S. PATENT DOCUMENTS**

D244,916	S	*	7/1977	Ueno	D10/38
D278,686	S	*	5/1985	Mathez	D10/39
D323,127	S	*	1/1992	Kawashima	D10/39

**OTHER PUBLICATIONS**

Wrist type mobile devices 001 (1/8-Designs-© Questel). orbit.com [online] 63 pages. Uploaded range from 2007-2014 [retrieved on Sep. 22, 2014]. Retrieved from Internet: <<http://sobjprd.questel.fr/export/QPTUJ214/pdf2/2f78fa37-6e03-40fa-b853-941e65da78d9-175438.pdf>>.\*

(Continued)

*Primary Examiner* — Susan Bennett Hattan

*Assistant Examiner* — Marie Fast Horse

(74) *Attorney, Agent, or Firm* — Birch, Stewart, Kolasch & Birch, LLP

(57) **CLAIM**

The ornamental design for a mobile phone, as shown and described.

**DESCRIPTION**

FIG. 1 is a perspective view of a mobile phone showing our new design;  
FIG. 2 is a front view thereof;  
FIG. 3 is a rear view thereof;  
FIG. 4 is a left side view thereof;  
FIG. 5 is a right side view thereof;  
FIG. 6 is a top plan view thereof; and,  
FIG. 7 is a bottom plan view thereof.  
The broken lines depict portions of the mobile phone that form no part of the claimed design.

**1 Claim, 7 Drawing Sheets**

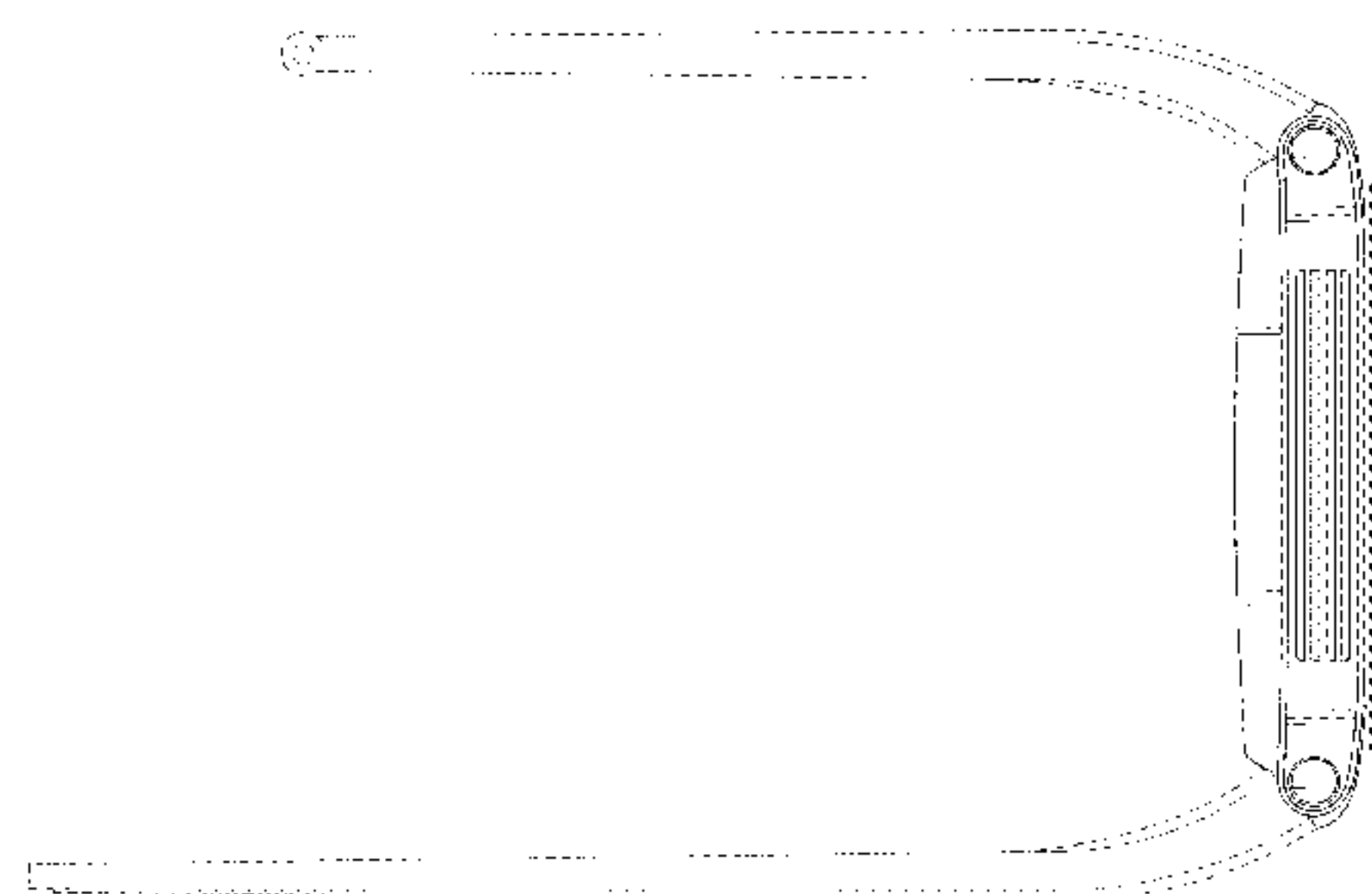
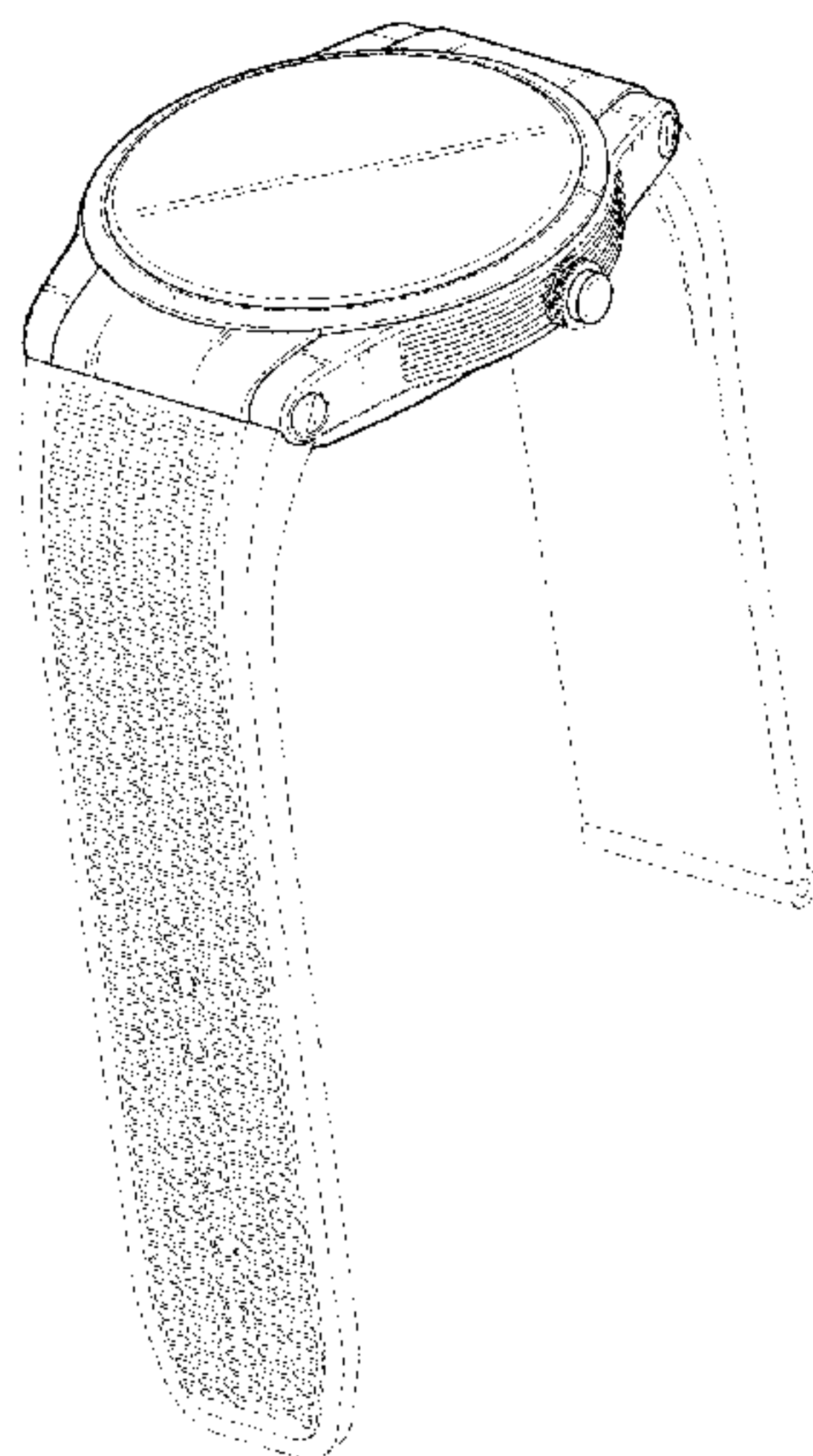

(56)

References Cited

U.S. PATENT DOCUMENTS

D395,241 S \* 6/1998 Galli ..... D10/30  
 D398,540 S \* 9/1998 Lee ..... D10/30  
 D399,758 S \* 10/1998 Mendoza ..... D10/30  
 D401,866 S \* 12/1998 Pandel ..... D10/32  
 D402,565 S \* 12/1998 Sato et al. .... D10/32  
 5,883,861 A \* 3/1999 Moser et al. .... 368/10  
 5,974,000 A \* 10/1999 Pfeil ..... 368/10  
 D416,204 S \* 11/1999 Hsu ..... D10/30  
 D424,451 S \* 5/2000 Houlihan ..... D10/30  
 D427,915 S \* 7/2000 Erediano ..... D10/30  
 6,094,403 A \* 7/2000 Tran et al. .... 368/10  
 D429,651 S \* 8/2000 Ventrella ..... D10/30  
 6,168,055 B1 \* 1/2001 Grados ..... 224/152  
 6,185,157 B1 \* 2/2001 Farine ..... 368/10  
 6,192,253 B1 \* 2/2001 Charlier et al. .... 455/575.7  
 D439,526 S \* 3/2001 Ramos, Jr. .... D10/30  
 D441,303 S \* 5/2001 Hanagata ..... D10/30  
 D445,345 S \* 7/2001 Ramos, Jr. .... D10/30  
 D451,825 S \* 12/2001 Hanagata ..... D10/30  
 6,335,906 B1 \* 1/2002 Engelmann ..... 368/10  
 D456,277 S \* 4/2002 Streltsov ..... D10/30  
 6,366,538 B1 \* 4/2002 Anderson et al. .... 368/10  
 D457,818 S \* 5/2002 Avranches ..... D10/39  
 D458,153 S \* 6/2002 Gensini ..... D10/30  
 D462,622 S \* 9/2002 Sugisawa ..... D10/30  
 D462,623 S \* 9/2002 Fujihara ..... D10/30  
 6,535,461 B1 \* 3/2003 Karhu ..... 368/10  
 D472,820 S \* 4/2003 Ditullo et al. .... D10/30  
 D496,868 S \* 10/2004 Yamamoto ..... D10/30  
 D512,922 S \* 12/2005 Yan ..... D10/32  
 6,990,047 B1 \* 1/2006 Barbagiovanni et al. .... 368/10  
 D517,433 S \* 3/2006 Jorst et al. .... D10/39  
 D526,216 S \* 8/2006 Tomimatsu ..... D10/39  
 7,113,451 B1 \* 9/2006 Matthey ..... 368/10  
 D535,198 S \* 1/2007 Maeder ..... D10/32  
 7,215,600 B1 \* 5/2007 DeRosa ..... 368/10  
 D559,125 S \* 1/2008 Figueiredo et al. .... D10/38  
 D564,366 S \* 3/2008 Yeh et al. .... D10/30  
 7,372,778 B2 \* 5/2008 Klopfenstein et al. .... 368/10  
 D579,791 S \* 11/2008 Hoshino ..... D10/38  
 D580,796 S \* 11/2008 Calvani ..... D10/33

7,447,118 B1 \* 11/2008 Matos ..... 368/10  
 D591,180 S \* 4/2009 Monachon ..... D10/39  
 D626,017 S \* 10/2010 Ahlstrom ..... D10/31  
 D631,377 S \* 1/2011 Jorst et al. .... D10/39  
 7,954,680 B2 \* 6/2011 Ishihara et al. .... 224/177  
 D650,705 S \* 12/2011 Blank ..... D10/32  
 D653,565 S \* 2/2012 Hegi ..... D10/38  
 D653,968 S \* 2/2012 Blank ..... D10/32  
 D661,206 S \* 6/2012 Register et al. .... D10/38  
 D674,710 S \* 1/2013 Monachon ..... D10/32  
 D681,482 S \* 5/2013 Ramos, Jr. .... D10/38  
 D684,066 S \* 6/2013 Messmer et al. .... D10/39  
 8,773,847 B2 \* 7/2014 Byun et al. .... 361/679.03  
 2001/0055243 A1 \* 12/2001 Haywood ..... 368/10  
 2002/0027832 A1 \* 3/2002 Engelmann ..... 368/10  
 2002/0110049 A1 \* 8/2002 Ting ..... 368/10  
 2003/0081506 A1 \* 5/2003 Karhu ..... 368/10  
 2003/0103413 A1 \* 6/2003 Jacobi et al. .... 368/10  
 2004/0013042 A1 \* 1/2004 Farine ..... 368/10  
 2004/0081025 A1 \* 4/2004 Chen ..... 368/10  
 2006/0211410 A1 \* 9/2006 Deniau et al. .... 455/412.1  
 2007/0210975 A1 \* 9/2007 Someya et al. .... 343/788  
 2007/0232373 A1 \* 10/2007 Yoshida et al. .... 455/575.6  
 2008/0004510 A1 \* 1/2008 Tanzawa et al. .... 600/301  
 2008/0089182 A1 \* 4/2008 Scheybal ..... 368/10  
 2009/0022014 A1 \* 1/2009 Gracia et al. .... 368/311  
 2010/0214877 A1 \* 8/2010 Turk ..... 368/10  
 2011/0128824 A1 \* 6/2011 Downey et al. .... 368/14  
 2012/0099406 A1 \* 4/2012 Lau et al. .... 368/69  
 2012/0170423 A1 \* 7/2012 Fujisawa ..... 368/10  
 2012/0320715 A1 \* 12/2012 Maruyama ..... 368/10  
 2013/0088942 A1 \* 4/2013 Perko et al. .... 368/278  
 2013/0163390 A1 \* 6/2013 Gossweiler et al. .... 368/14  
 2013/0250735 A1 \* 9/2013 Takenawa ..... 368/10  
 2014/0233358 A1 \* 8/2014 Fujisawa ..... 368/47

OTHER PUBLICATIONS

Wrist type mobile devices 002 (1/8-Designs-©Questel). orbit.com [online] 60 pages. Uploaded range from 1998-2014 [retrieved on Sep. 22, 2014]. Retrieved from Internet: <<http://sobjprd.questel.fr/export/QPTUJ214/pdf2/361cc6bb-a15b-41b7-9b86-bbe3af8a48ad-184028.pdf>>.\*

\* cited by examiner



FIG. 1

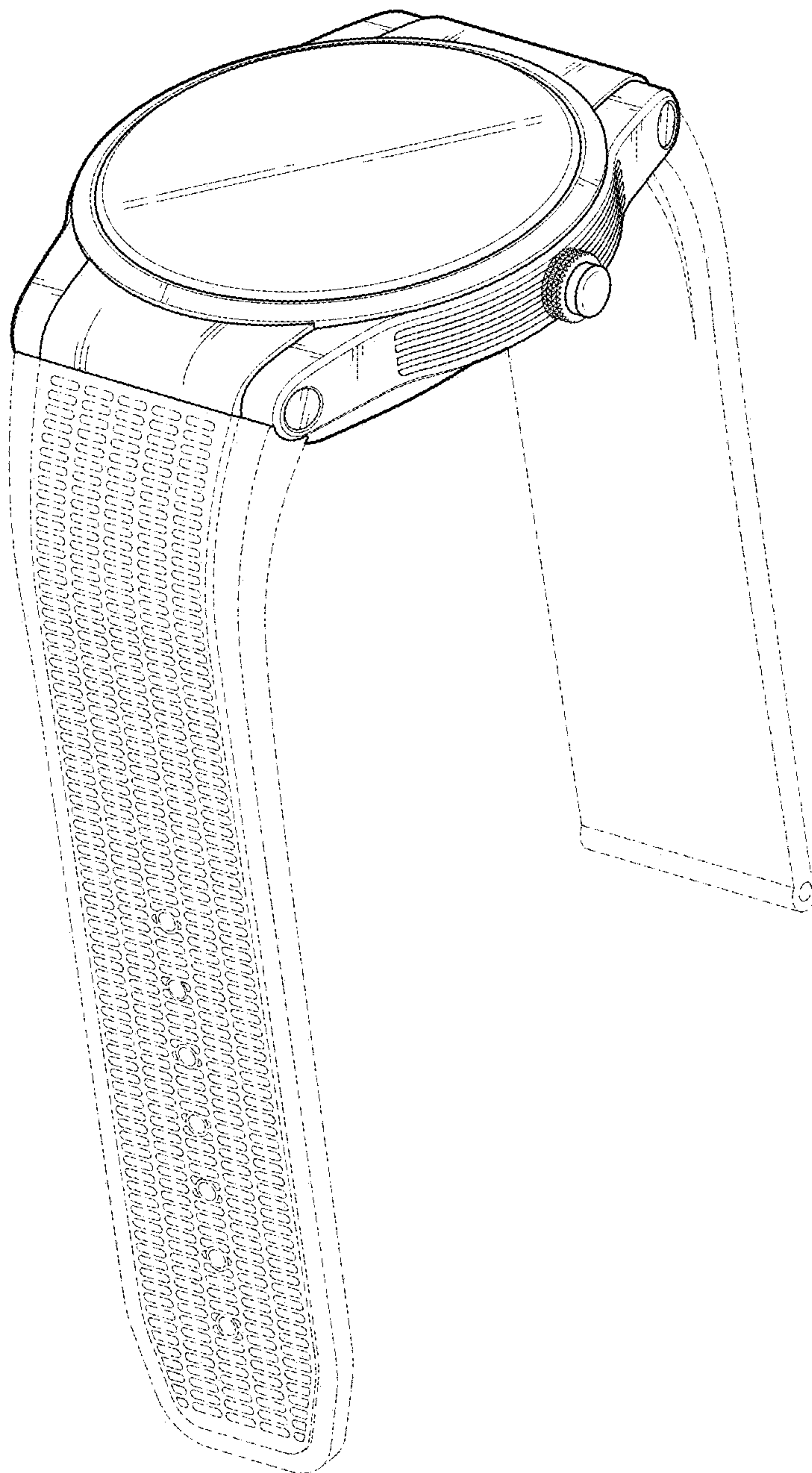

FIG. 2

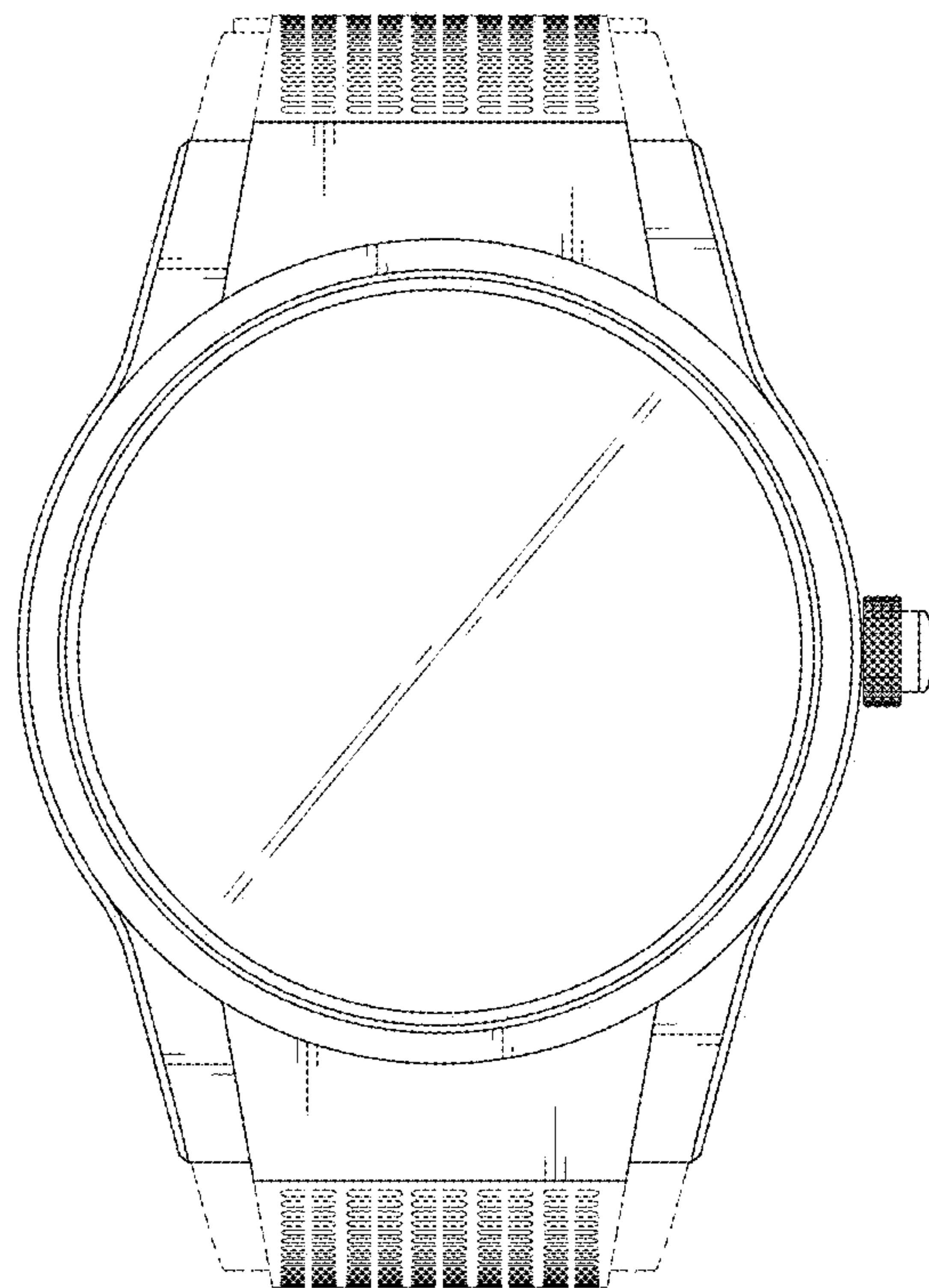

FIG. 3

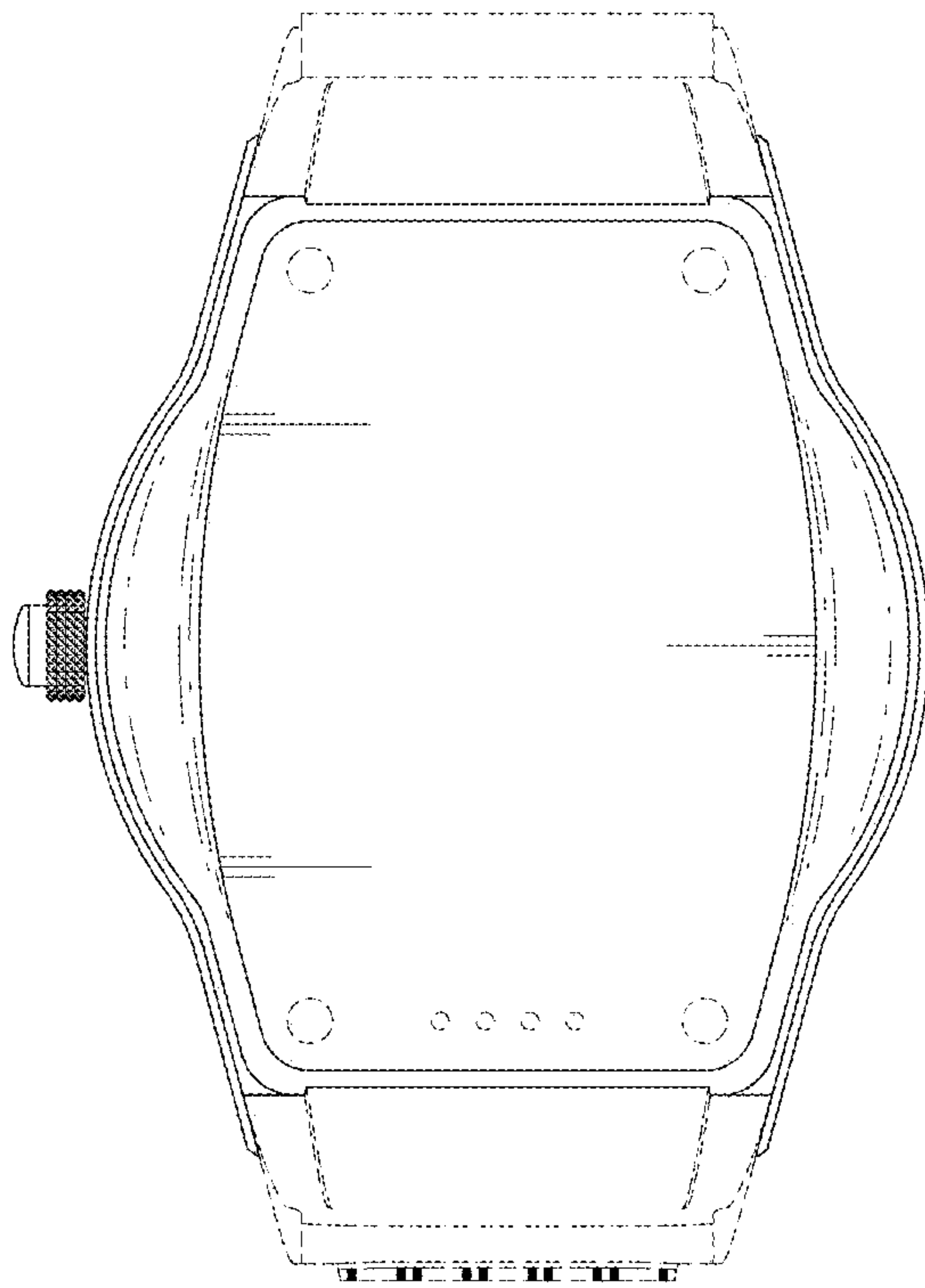

FIG. 4

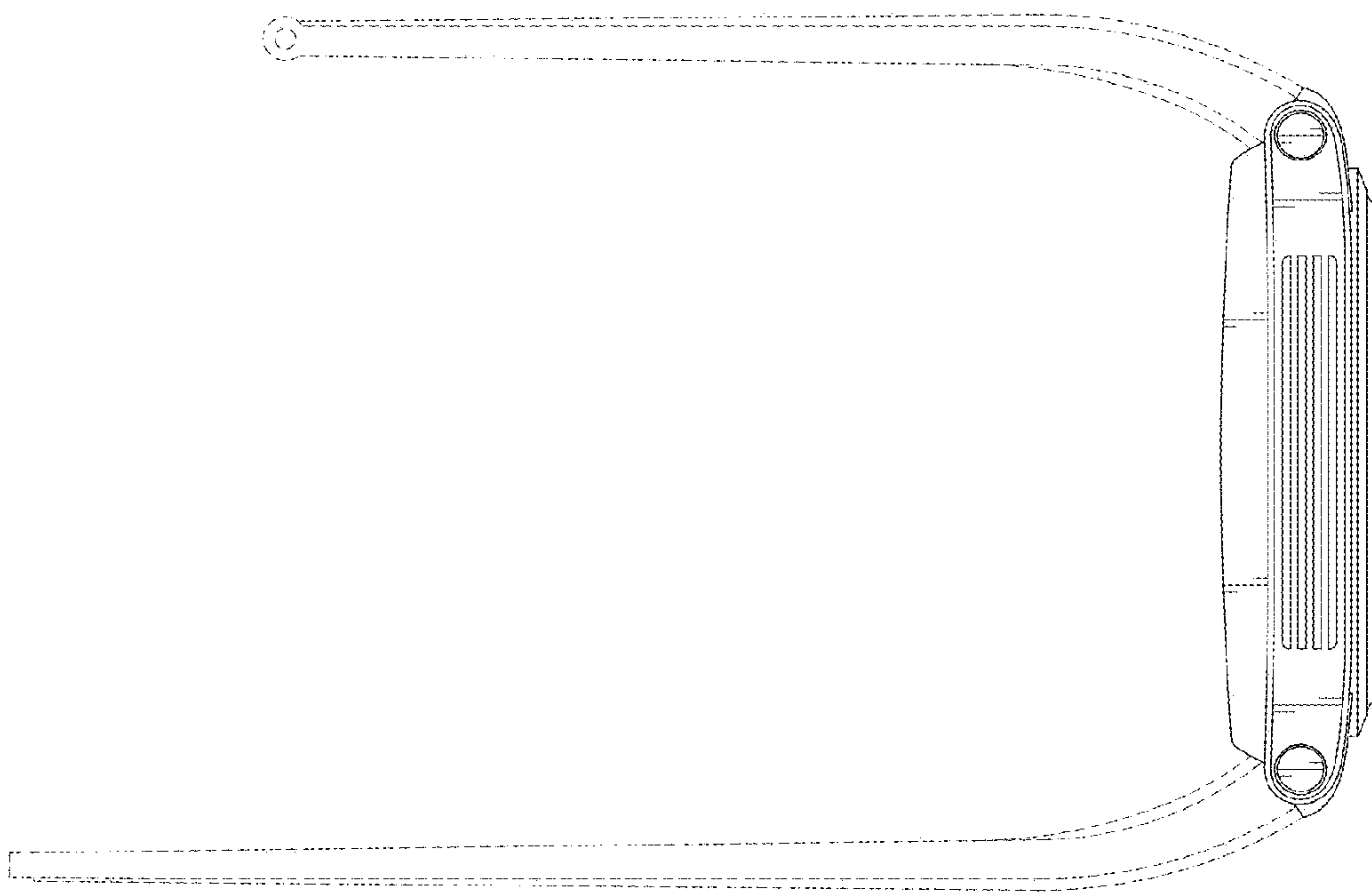

FIG. 5

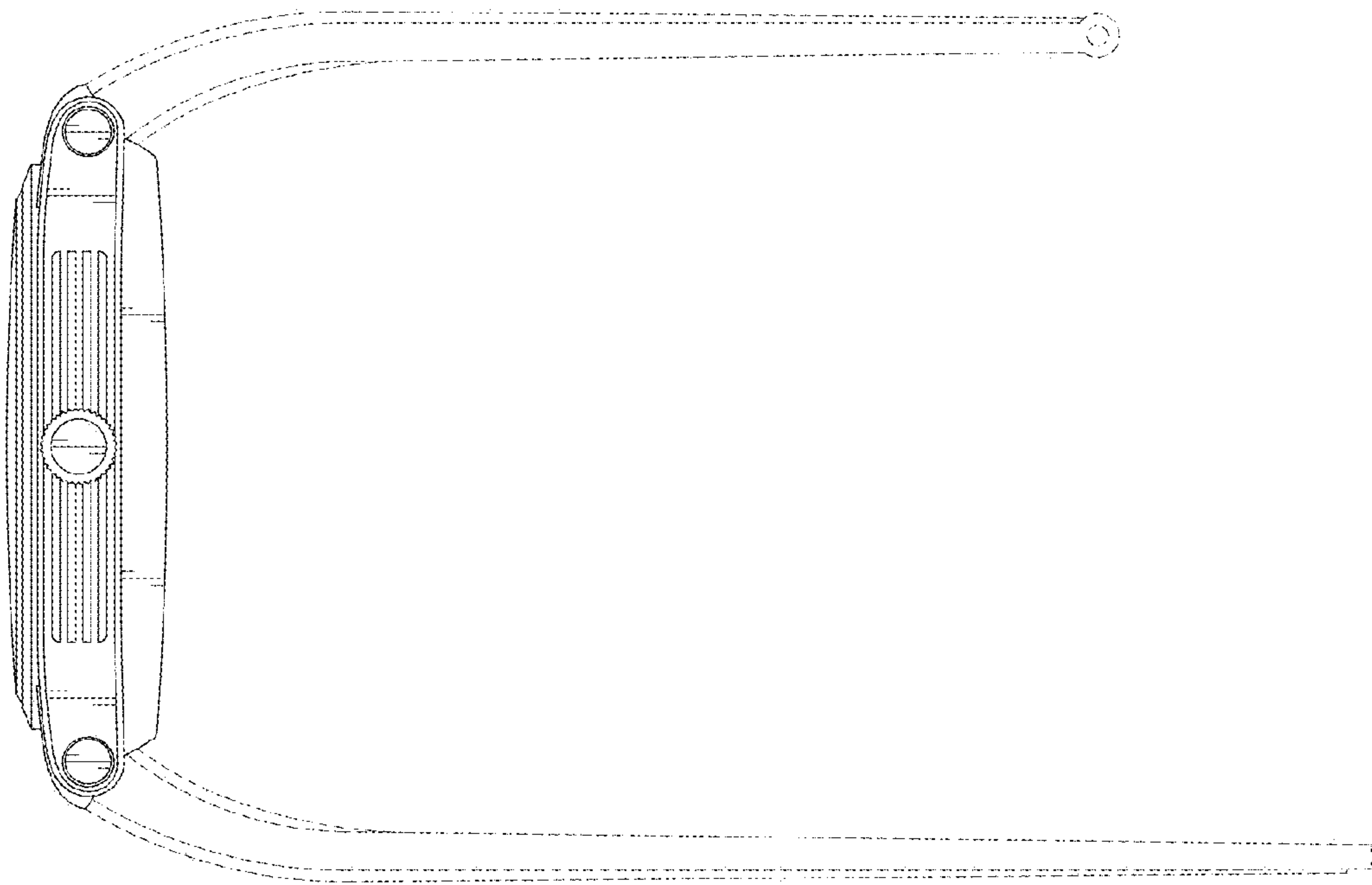

FIG. 6

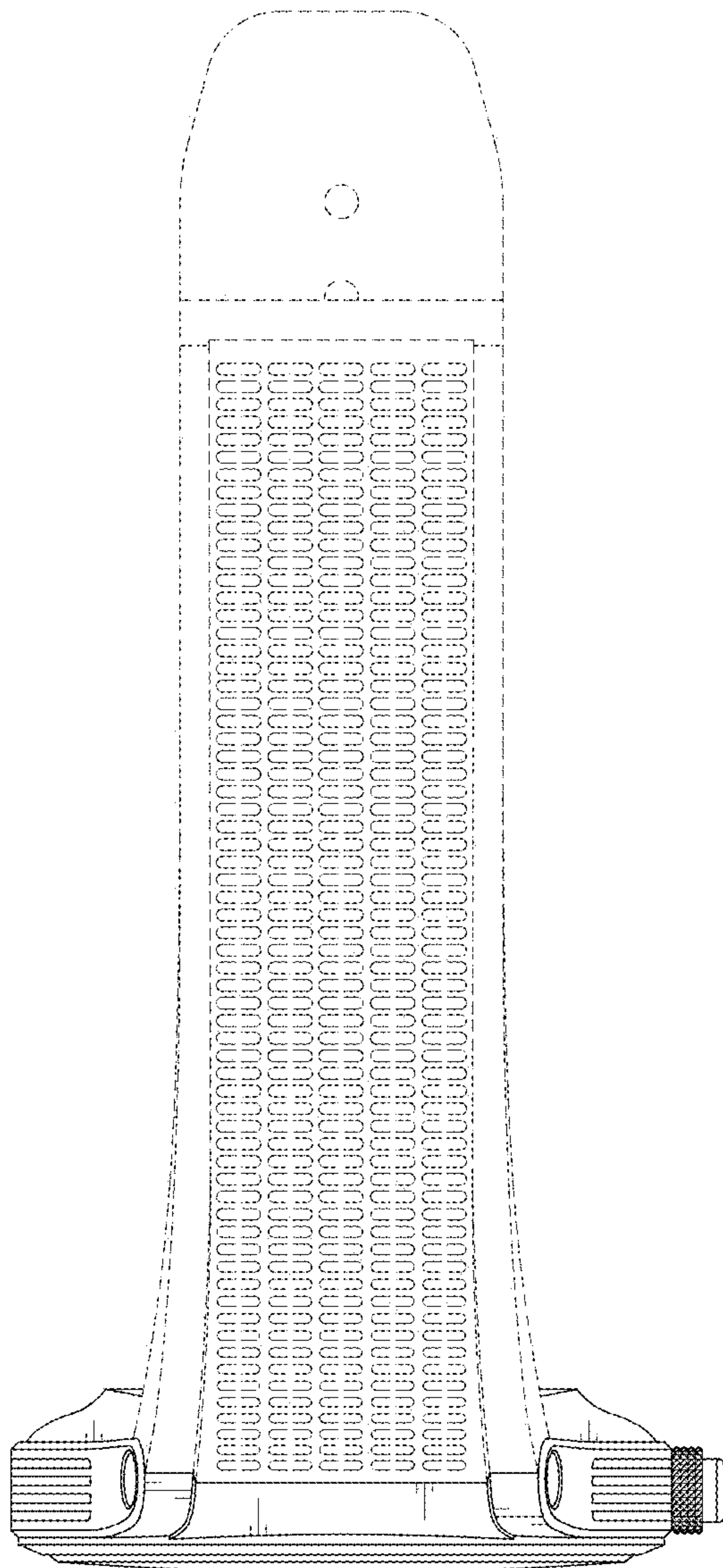



FIG. 7

