



US00D726464S

(12) **United States Design Patent**
Lin

(10) **Patent No.:** **US D726,464 S**
(45) **Date of Patent:** **** Apr. 14, 2015**

(54) **DESK STAND**

(71) Applicants: **Hi-Max Innovation Co., Ltd.**, Taichung (TW); **Yi-Chen Tseng**, Taichung (TW)

(72) Inventor: **Jhin-Fan Lin**, Taichung (TW)

(73) Assignees: **Hi-Max Innovation Co., Ltd.**, Taichung (TW); **Yi-Chen Tseng**, Taichung (TW)

(**) Term: **14 Years**

(21) Appl. No.: **29/465,802**

(22) Filed: **Aug. 30, 2013**

(51) **LOC (10) Cl.** **06-06**

(52) **U.S. Cl.**
USPC **D6/709**

(58) **Field of Classification Search**
USPC D6/641–643, 656, 656.1, 656.13, D6/656.14, 656.15, 656.16, 656.17, 708, D6/709, 709.2, 717, 648, 648.1; 108/50.01, 50.02; 248/188, 188.1, 248/188.8, 164; 312/194–196, 223.3; D14/305

See application file for complete search history.

(56) **References Cited**

U.S. PATENT DOCUMENTS

D188,605 S * 8/1960 Lubberts et al. D6/428
D332,361 S * 1/1993 Lewis D6/480

D396,358 S * 7/1998 Geier D6/349
D484,337 S * 12/2003 Risdon et al. D6/495
D517,835 S * 3/2006 O'Hare D6/422
D532,630 S * 11/2006 Rizzi D6/500
D569,132 S * 5/2008 Sexton D6/480
D573,366 S * 7/2008 Sexton D6/425
D589,656 S * 3/2009 Toltzman et al. D30/118
D668,884 S * 10/2012 Olano Jauregui D6/429

* cited by examiner

Primary Examiner — Janice Seeger

(74) *Attorney, Agent, or Firm* — Patent Office of Bang Shia

(57) **CLAIM**

The ornamental design for a desk stand, as shown and described.

DESCRIPTION

FIG. 1 is a perspective view of a desk stand showing my new design;
FIG. 2 is a front elevational view thereof;
FIG. 3 is a rear elevational view thereof;
FIG. 4 is a left side elevational view thereof;
FIG. 5 is a right side elevational view thereof;
FIG. 6 is a top plan view thereof; and,
FIG. 7 is a bottom plan view thereof.

The broken lines are shown for illustrative purposes only and form no part of claimed design.

1 Claim, 5 Drawing Sheets

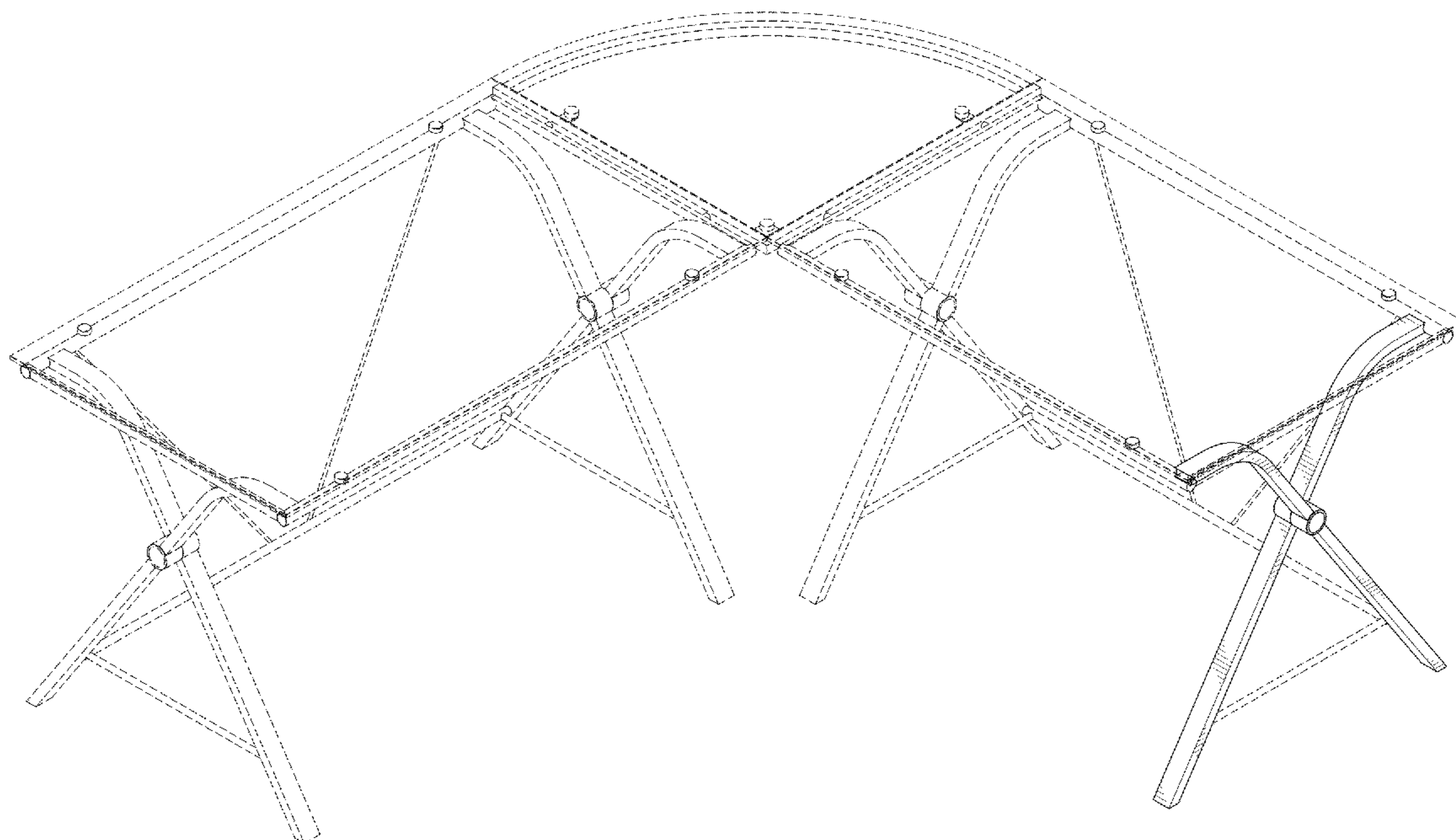

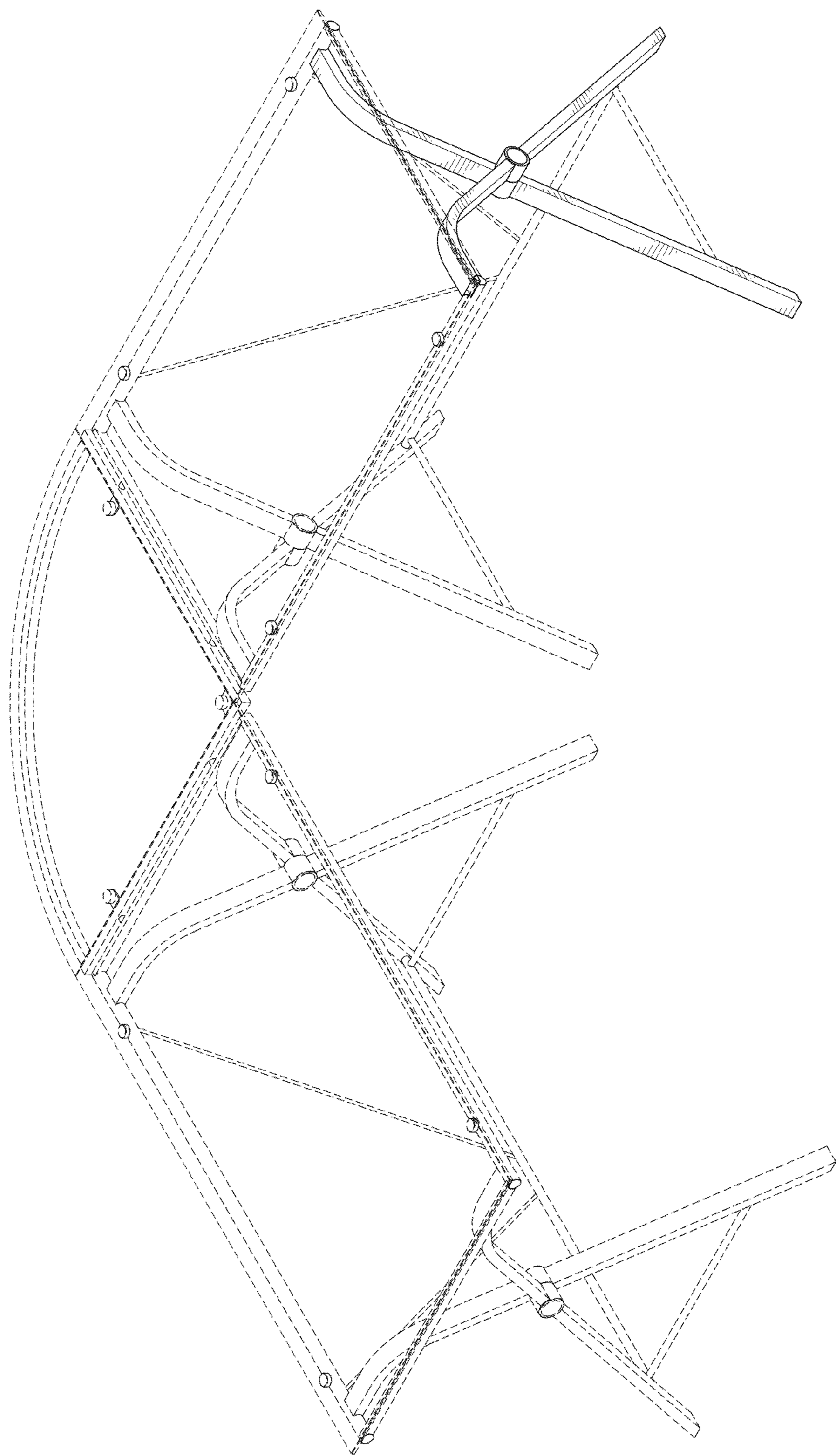

FIG.1

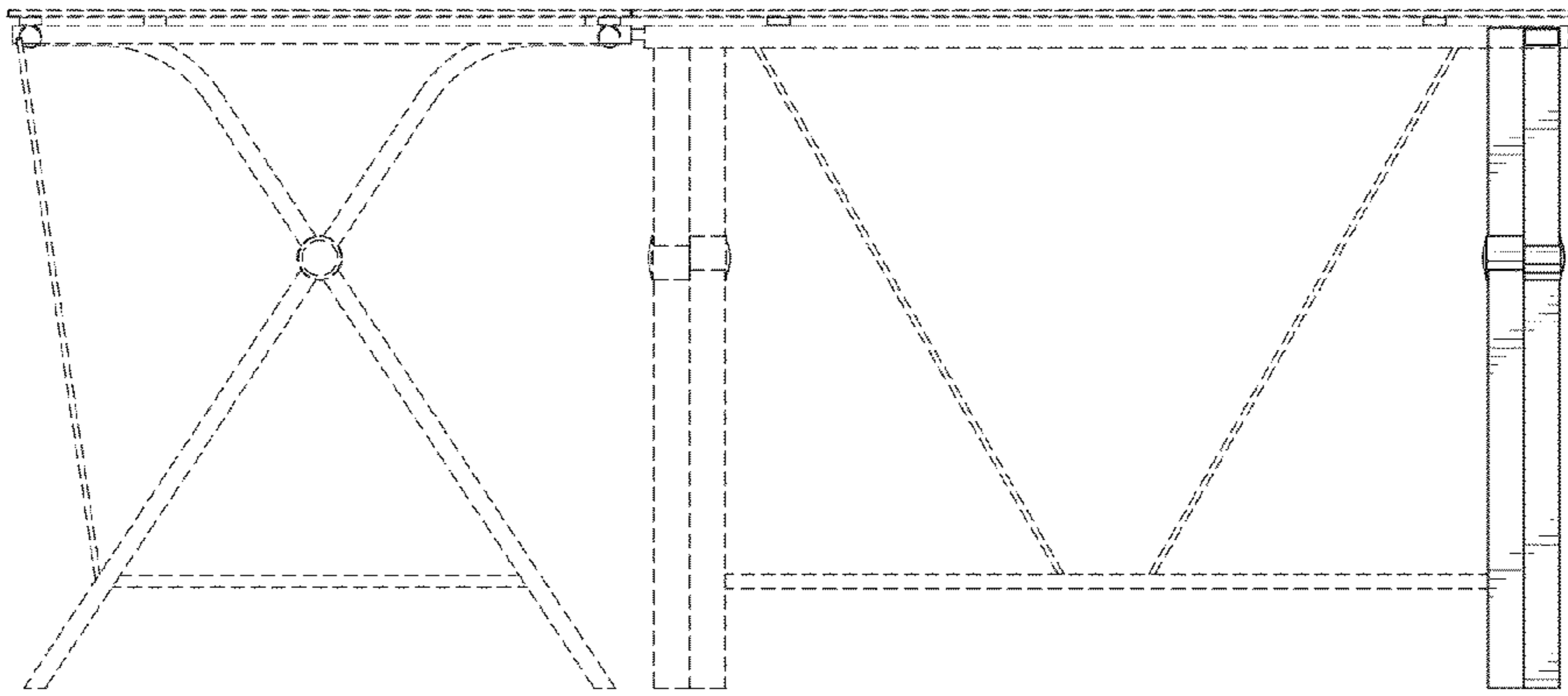

FIG. 2

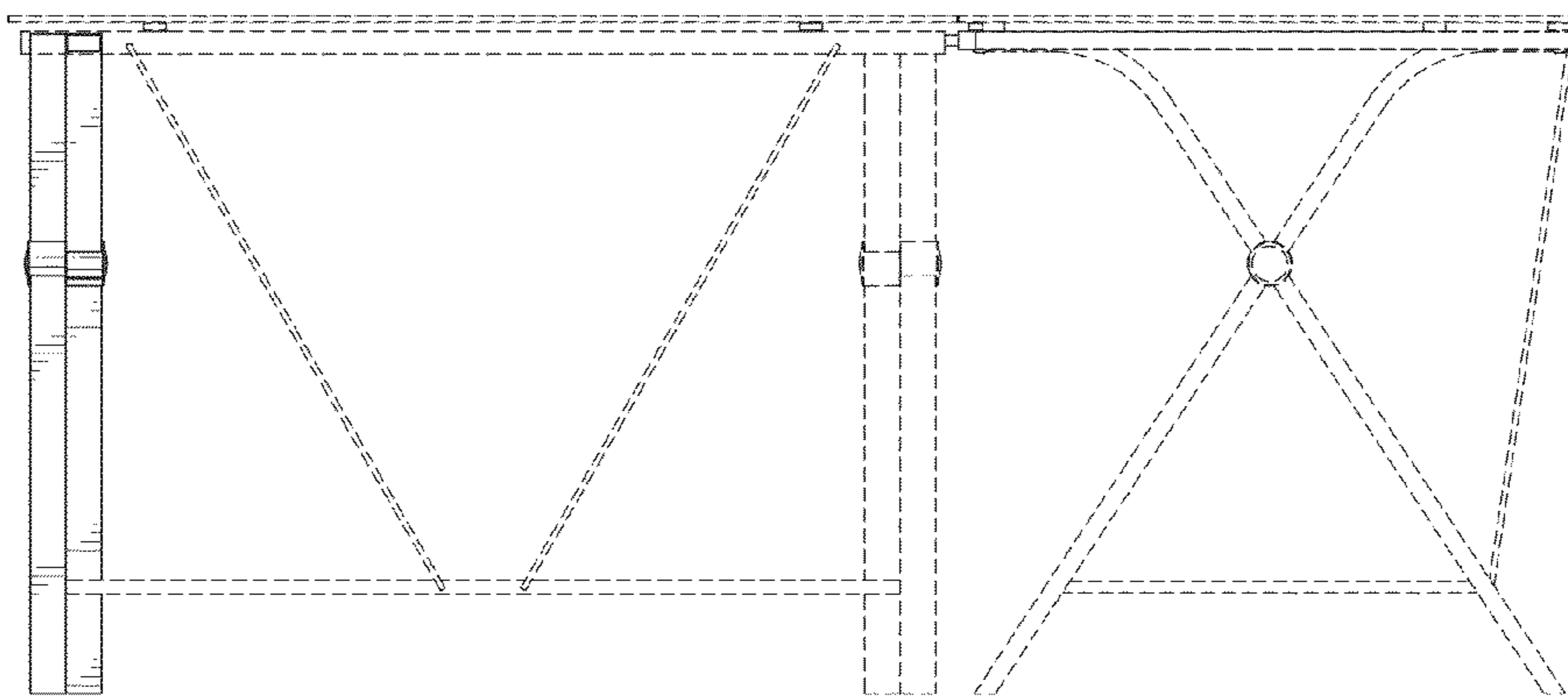

FIG. 3

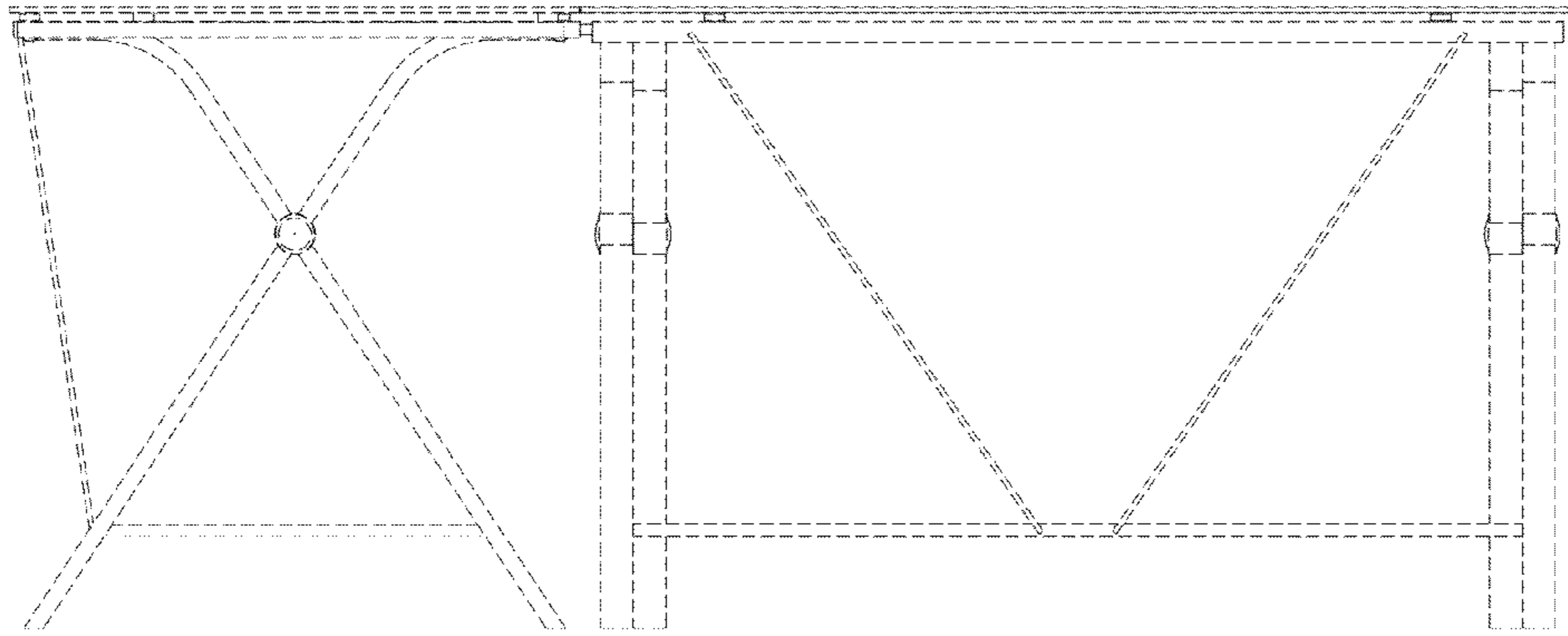

FIG. 4

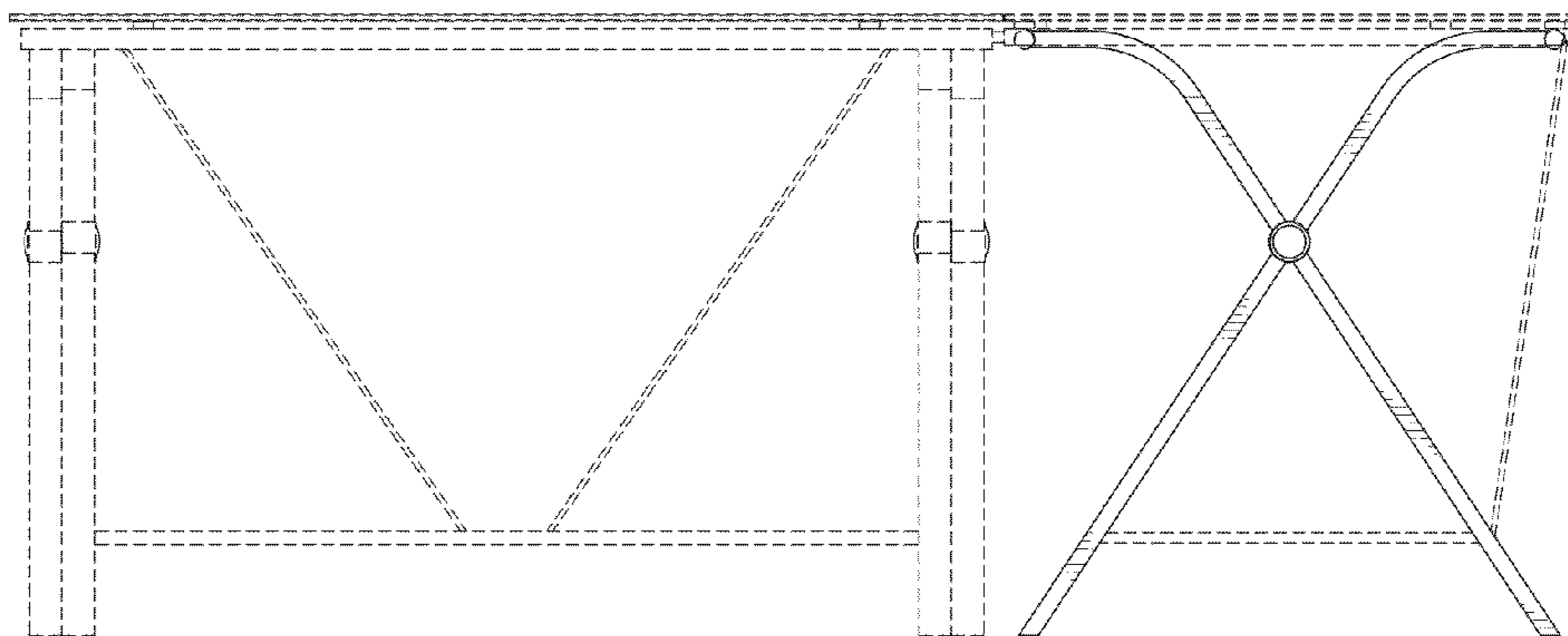

FIG. 5

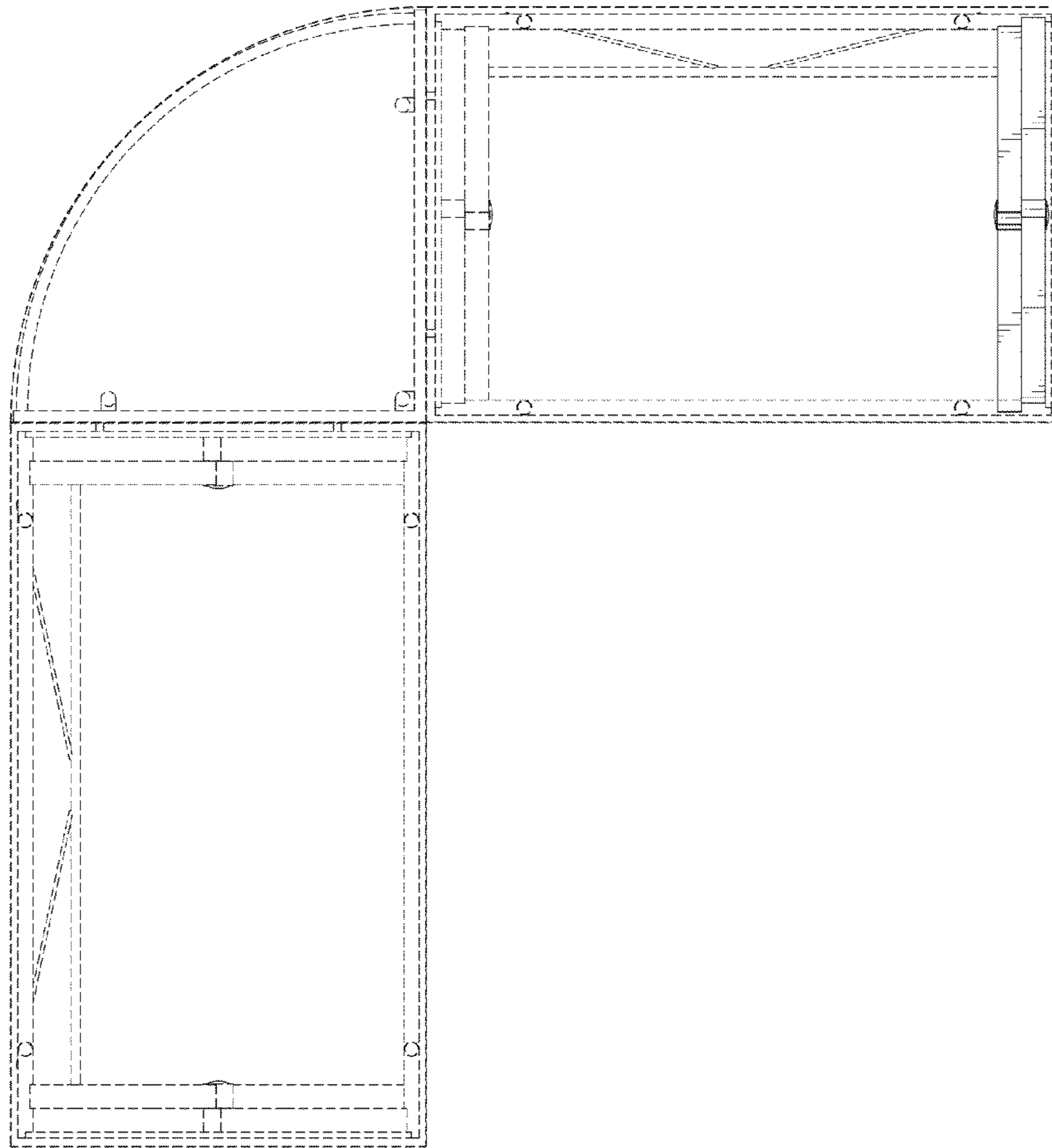

FIG.6

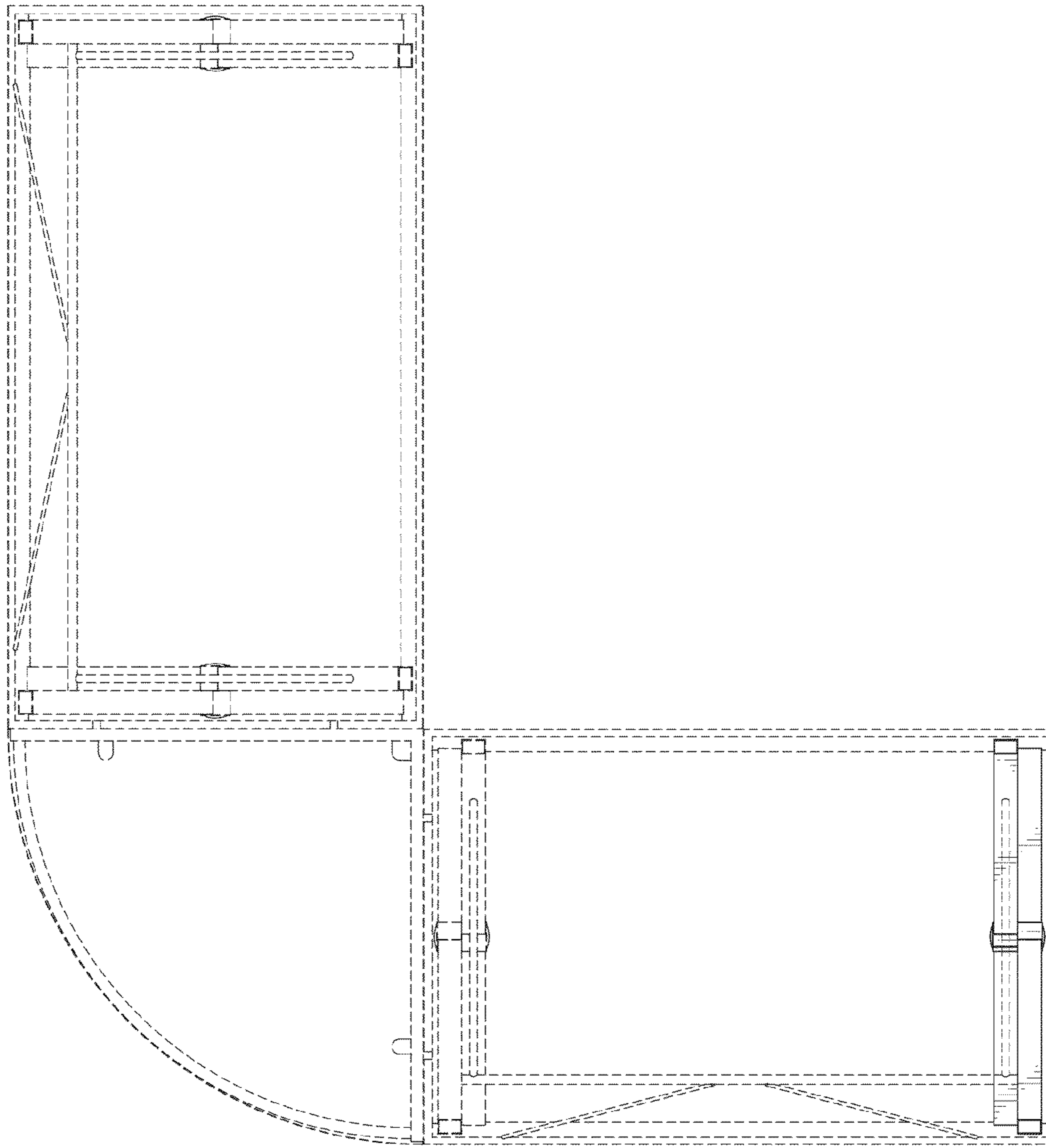

FIG. 7