



US00D726449S

(12) **United States Design Patent**
Faley et al.

(10) **Patent No.:** **US D726,449 S**
(45) **Date of Patent:** **** Apr. 14, 2015**

(54) **DOG-SHAPED PILLOW**

(71) Applicants: **Kelly Margaret Faley**, Oceanside, CA (US); **Mary Elizabeth Faley**, Oceanside, CA (US)

(72) Inventors: **Kelly Margaret Faley**, Oceanside, CA (US); **Mary Elizabeth Faley**, Oceanside, CA (US)

(**) Term: **14 Years**

(21) Appl. No.: **29/476,101**

(22) Filed: **Dec. 11, 2013**

(51) **LOC (10) Cl.** **06-09**

(52) **U.S. Cl.**
USPC **D6/598**

(58) **Field of Classification Search**
USPC D6/351, 388, 512, 564, 595, 596, 597, D6/598, 601; D21/576, 606, 611, 613; 5/482, 639, 636, 652; 446/268, 269
See application file for complete search history.

(56) **References Cited**

U.S. PATENT DOCUMENTS

D141,247 S *	5/1945	Denniston	D21/611
4,754,512 A *	7/1988	Chao-Yang	5/482
D348,171 S *	6/1994	Keller	D6/598
D397,900 S *	9/1998	Besen	D6/598
D408,671 S *	4/1999	Bear	D6/598
D418,554 S *	1/2000	E.	D21/613
D423,065 S *	4/2000	Wong	D21/611
D434,261 S *	11/2000	Rosenstadt et al.	D6/598
D437,898 S *	2/2001	Phillipson	D21/611
D445,623 S *	7/2001	Hartner	D6/598
6,560,802 B2 *	5/2003	Fujii	5/639
D520,798 S *	5/2006	Keller	D6/598
D607,065 S *	12/2009	Brown	D21/613

D610,629 S *	2/2010	Brown	D21/613
D610,630 S *	2/2010	Brown	D21/613
D610,631 S *	2/2010	Brown	D21/613
D610,632 S *	2/2010	Brown	D21/613
D610,633 S *	2/2010	Brown	D21/613
D672,995 S *	12/2012	Diaz	D6/598
D678,430 S *	3/2013	Montibert	D21/611
D707,308 S *	6/2014	Carlson	D21/611
2005/0150050 A1 *	7/2005	Wolf et al.	5/636

OTHER PUBLICATIONS

#94 Crochet Hound Pillow Toy [online]. Coats &Clark, 2011 [retrieved on Nov. 13, 2014]. Retrieved from the Internet: <http://toycrochet.blogspot.com/...rochet-hound-pillow-toy-by-coats.html#!/2011/08/94-crochet-hound-pillow-toy-by-coats.html>.*
Super Soft Labrador Body Pillow with Realistic Features [online]. Plow and Hearth, Winter 2014 [retrieved on Nov. 13, 2014]. Retrieved from the Internet: <http://www.plowhearth.com/super-soft-labrador-body-pillow-with-realistic-features.htm>.*

* cited by examiner

Primary Examiner — Mary Ann Calabrese

Assistant Examiner — Jennifer L Rempfer

(57) **CLAIM**

The ornamental design for a dog-shaped pillow, as shown and described.

DESCRIPTION

FIG. 1 is a perspective view of a dog-shaped pillow; FIG. 2 is a front elevation view of the dog-shaped pillow; FIG. 3 is a rear elevation view of the dog-shaped pillow; FIG. 4 is a left elevation view of the dog-shaped pillow; right elevation view is a mirror image thereof; FIG. 5 is a top elevation view of the dog-shaped pillow; and, FIG. 6 is a bottom elevation view of the dog-shaped pillow.

1 Claim, 4 Drawing Sheets

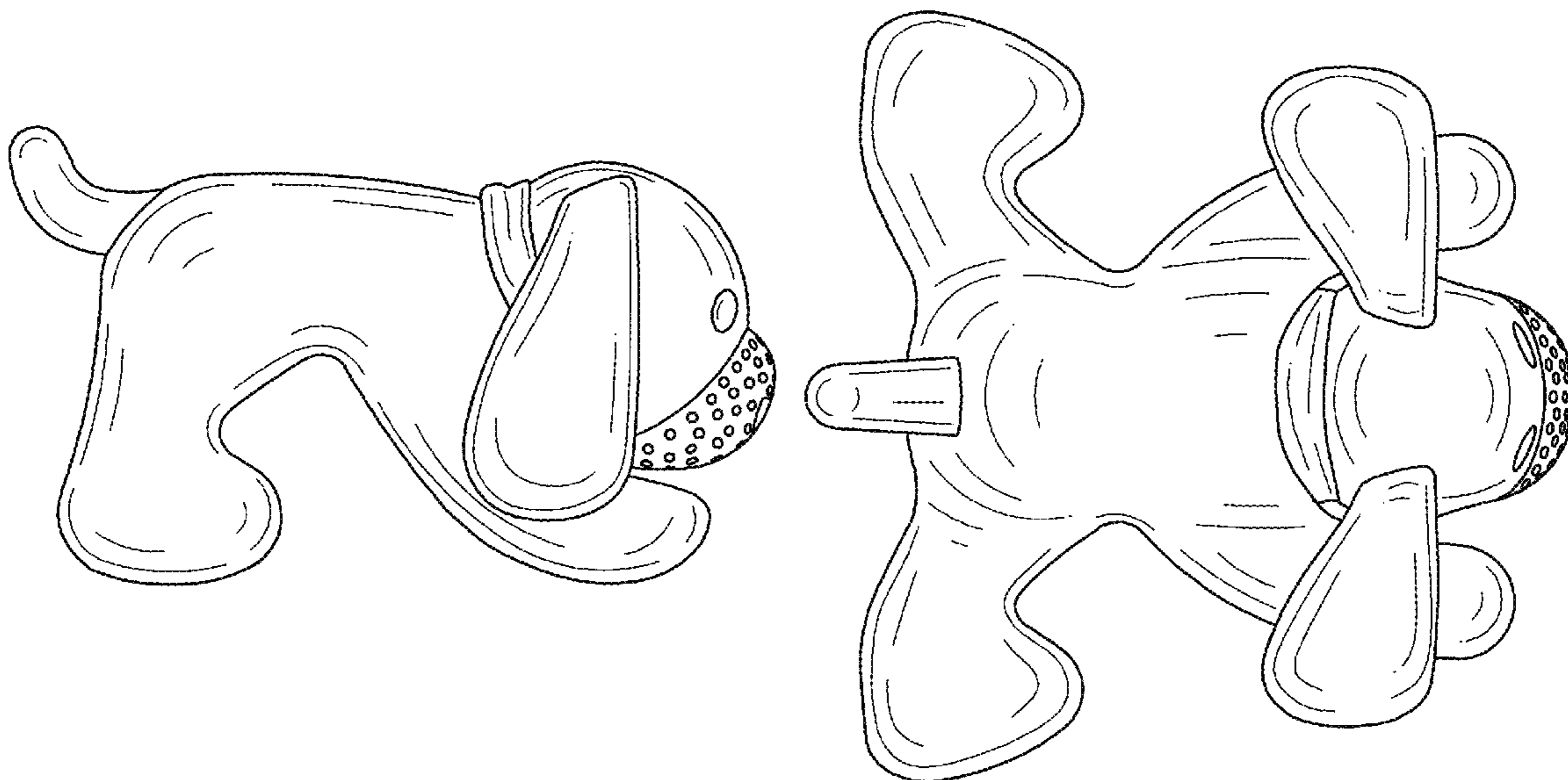

FIG. 1

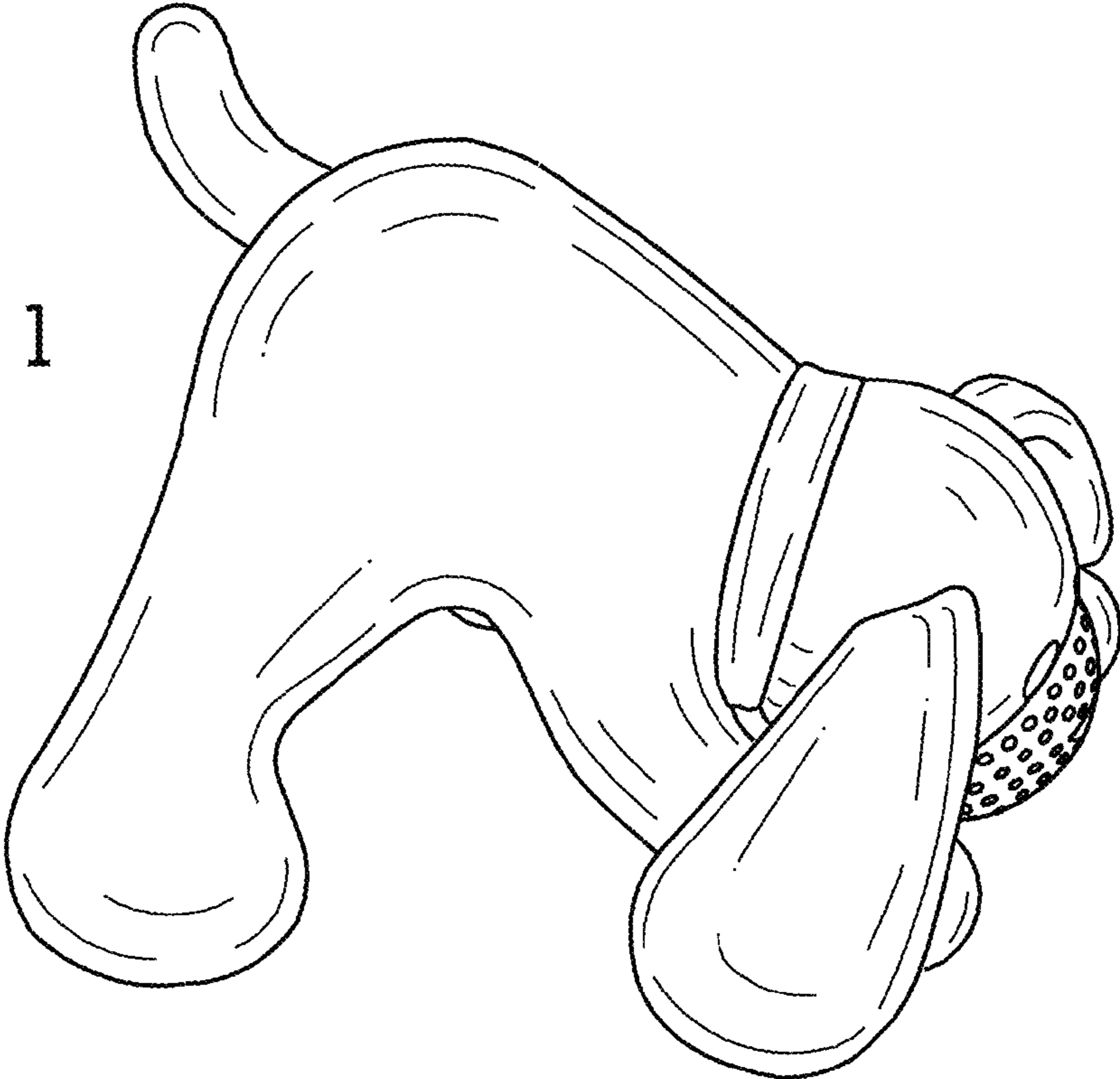

FIG. 2

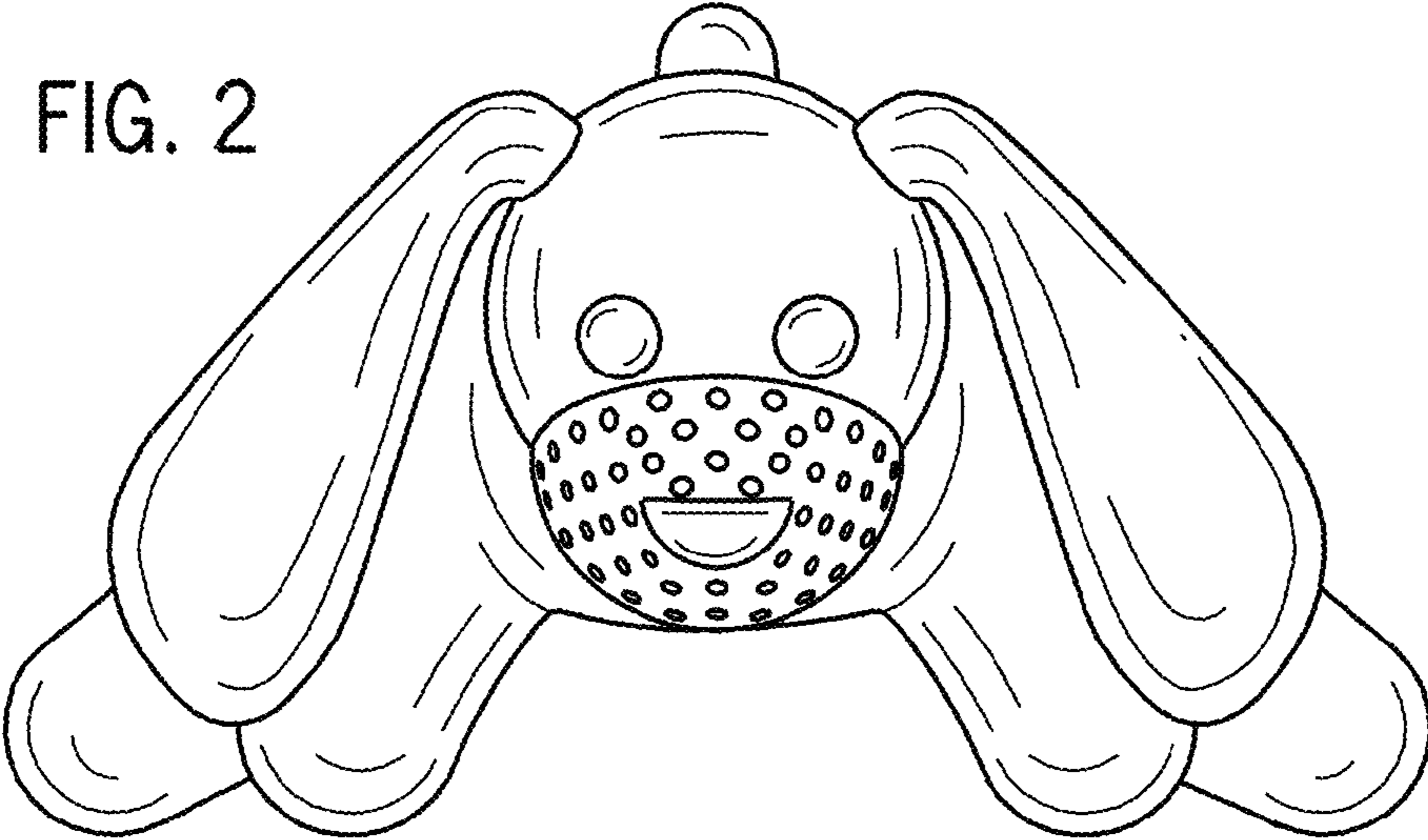

FIG. 3

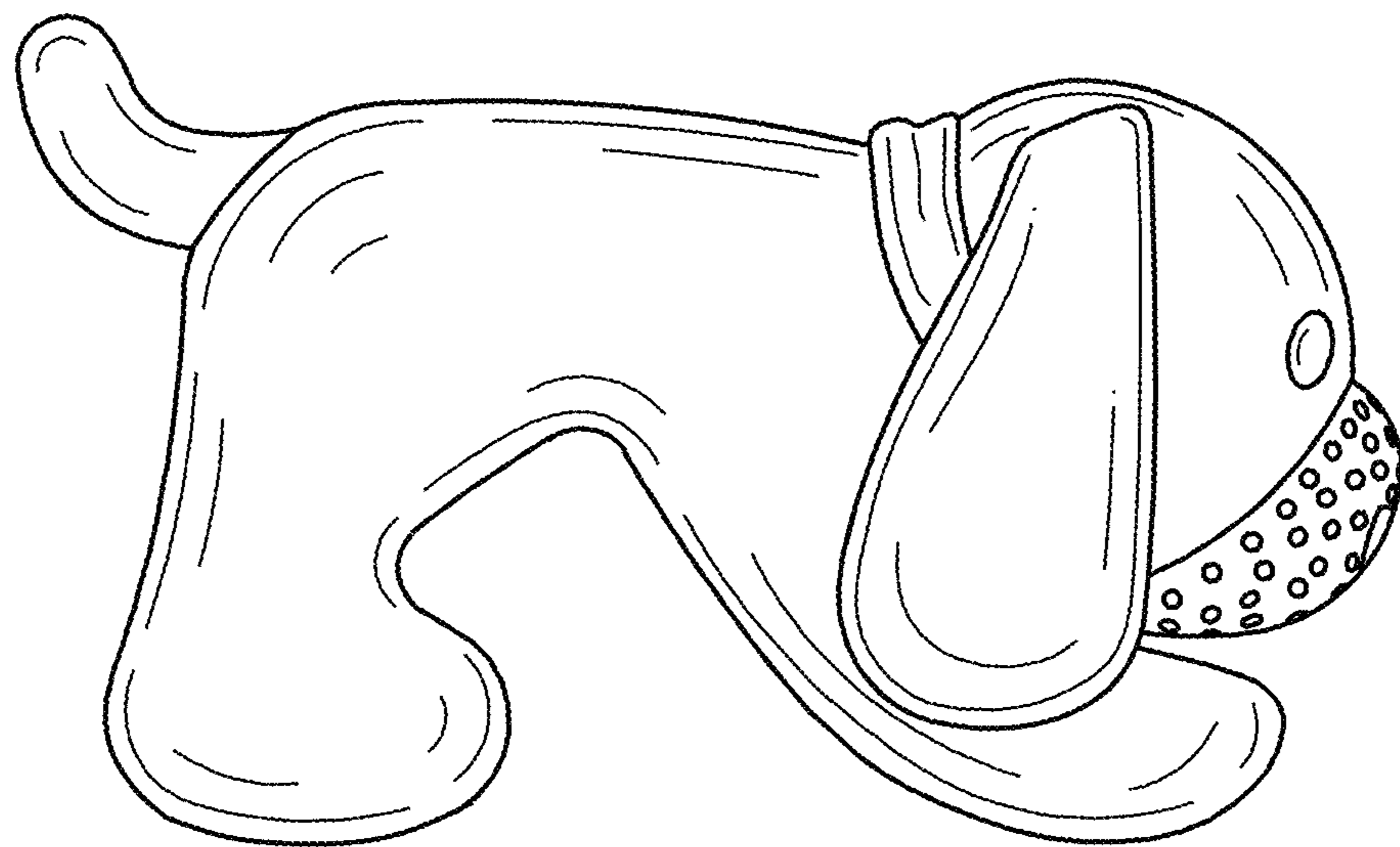
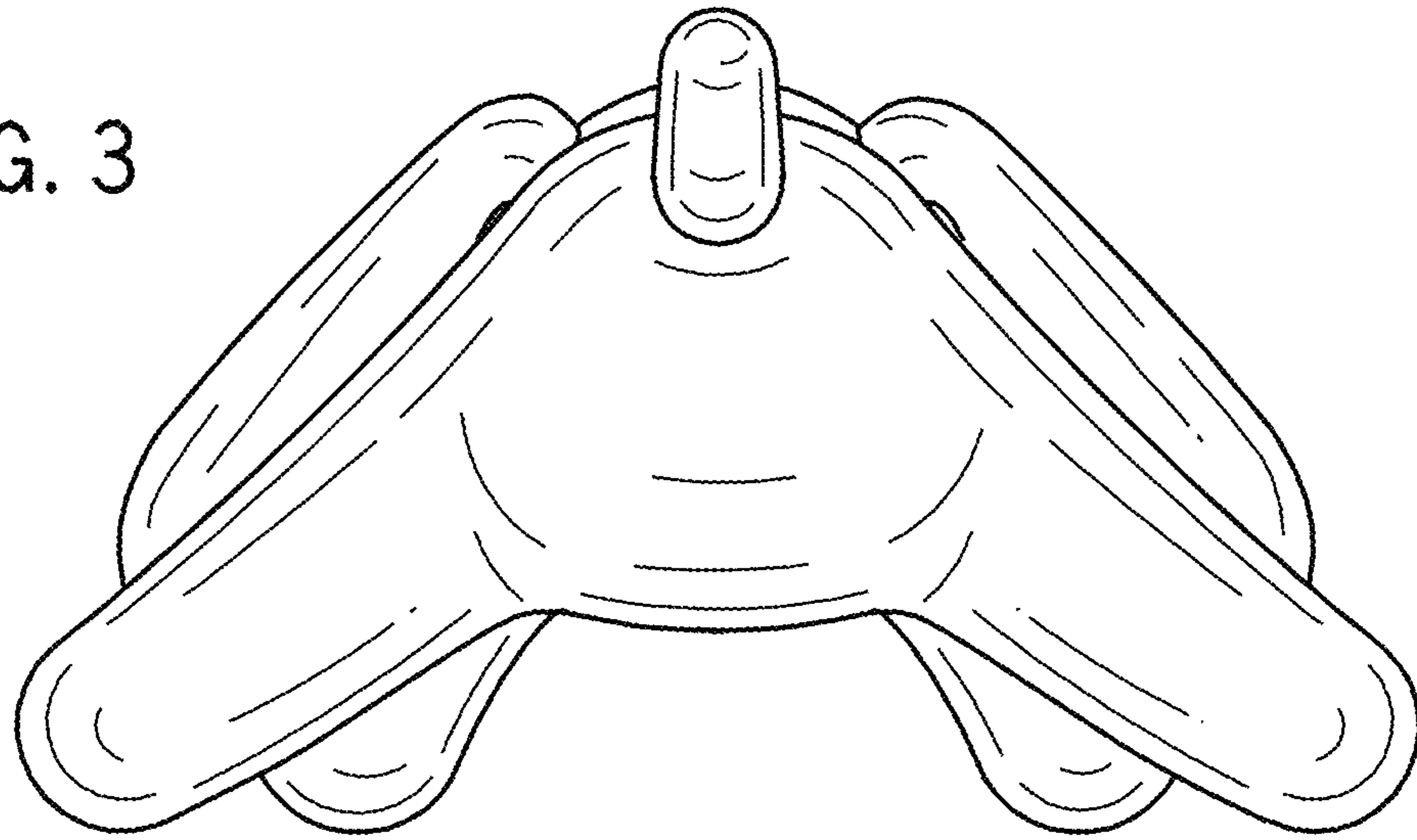

FIG. 4

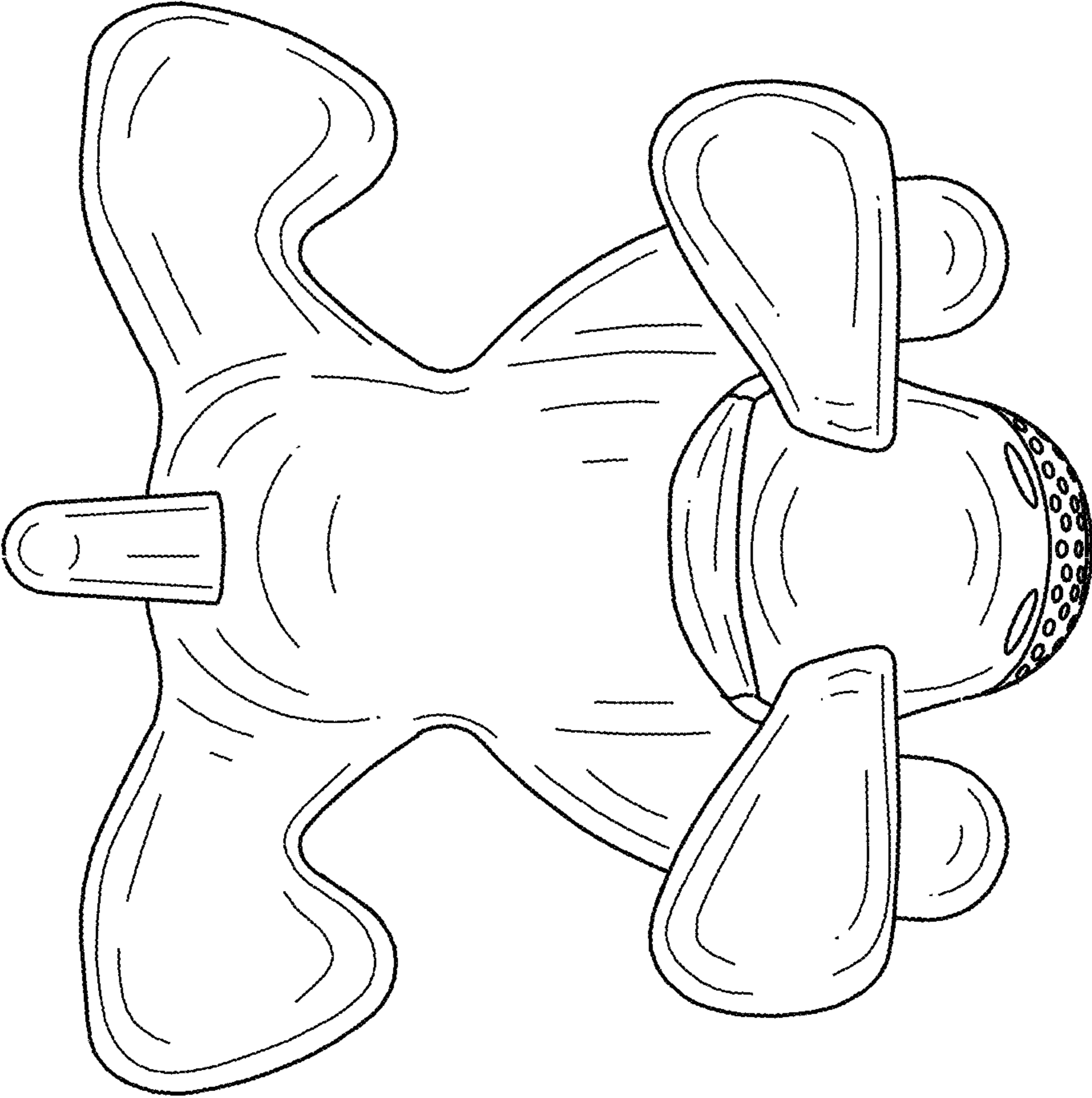

FIG. 5

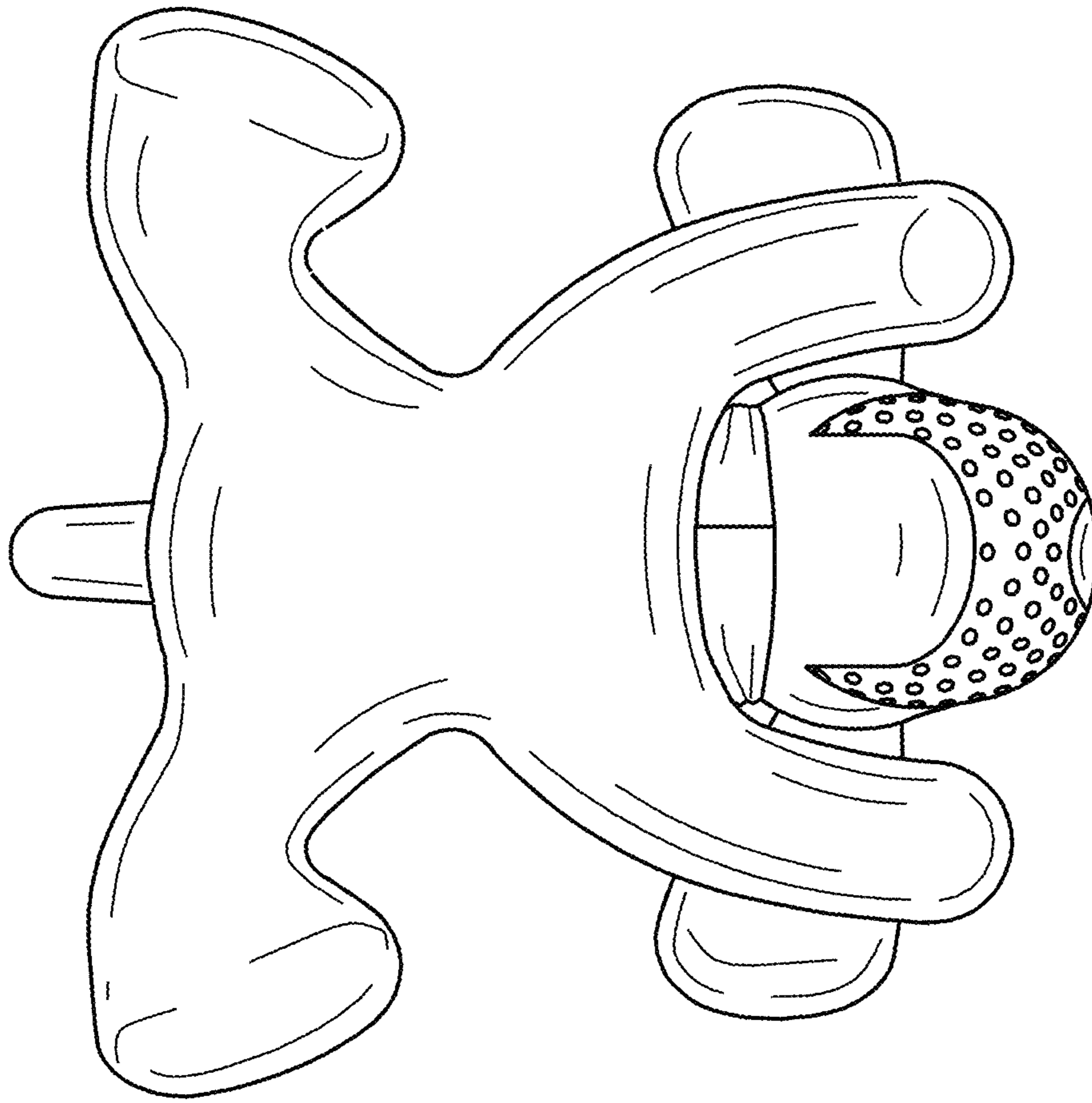

FIG. 6