



US00D726438S

(12) **United States Design Patent**
Morgan

(10) **Patent No.:** **US D726,438 S**
(45) **Date of Patent:** **** Apr. 14, 2015**

- (54) **FLOWER POT**
- (71) Applicant: **Scott N. Morgan**, Seattle, WA (US)
- (72) Inventor: **Scott N. Morgan**, Seattle, WA (US)
- (**) Term: **14 Years**
- (21) Appl. No.: **29/464,777**
- (22) Filed: **Aug. 21, 2013**
- (51) **LOC (10) Cl.** **06-06**
- (52) **U.S. Cl.**
USPC **D6/404**
- (58) **Field of Classification Search**
USPC D6/403–405, 556–559, 570;
D11/143–156, 164; D19/77, 80, 81,
D19/84; D25/15, 100, 105, 113; D26/9, 10,
D26/11, 16, 19; D34/1, 2, 4–6; 47/17, 32.4,
47/32.5, 32.7, 33, 39, 41.01, 41.1,
47/41.11–41.15, 44–47, 63, 65.5, 65.9,
47/66.6, 66.7, 67–71; D8/1
See application file for complete search history.

D647,370 S	10/2011	van Dijk et al.	
D651,938 S	1/2012	Christie	
D653,474 S	2/2012	Garcia et al.	
2013/0219589 A1 *	8/2013	Jones	2/227
2014/0165265 A1 *	6/2014	Tulin et al.	2/234

OTHER PUBLICATIONS

Jean Planters by Dad’s Route 66 Blog. dated Jul. 17, 2011. found online [Oct. 24, 2014] <http://route66.mightythorproductions.com/route66-dad/?p=922>.*

Holster detail by Carrie dated Mar. 10, 2009. found online [Oct. 24, 2013] <https://www.flickr.com/photos/9102223@N07/3344163969>.*

* cited by examiner

Primary Examiner — Robert M Spear
Assistant Examiner — Marissa J Cash

(57) **CLAIM**

The ornamental design for a flower pot, as shown and described.

DESCRIPTION

FIG. 1 is a front view of a flower pot showing my new design; FIG. 2 is a rear view of the flower pot; FIG. 3 is a left side view of the flower pot; FIG. 4 is a right side view of the flower pot; FIG. 5 is a top view of the flower pot, a bottom view thereof having no ornamental features; and, FIG. 6 is a cross-sectional view taken along line 6-6 of FIG. 4 to show the depth of the container within the flower pot. The broken lines in the drawings represent unclaimed environmental subject matter and form no part of the claim.

1 Claim, 5 Drawing Sheets

(56) **References Cited**
U.S. PATENT DOCUMENTS

D106,131 S	9/1937	Butler	
D176,798 S	1/1956	Klingberg	
D189,856 S	3/1961	Doran	
D246,637 S *	12/1977	Kawade	D11/149
D296,607 S *	7/1988	Iber	D2/898
D340,006 S	10/1993	Barger, III	
D351,525 S *	10/1994	Alexander	D6/597
D450,261 S	11/2001	Steere	
D565,459 S	4/2008	Fears	

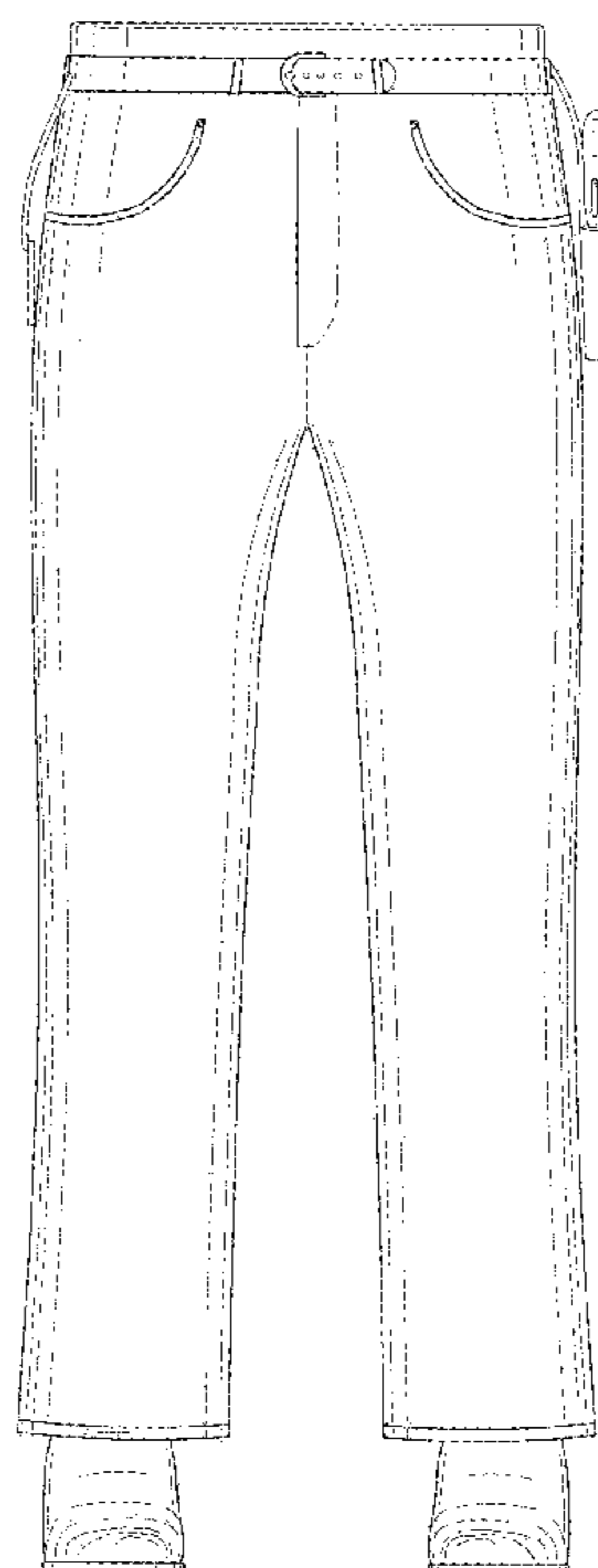

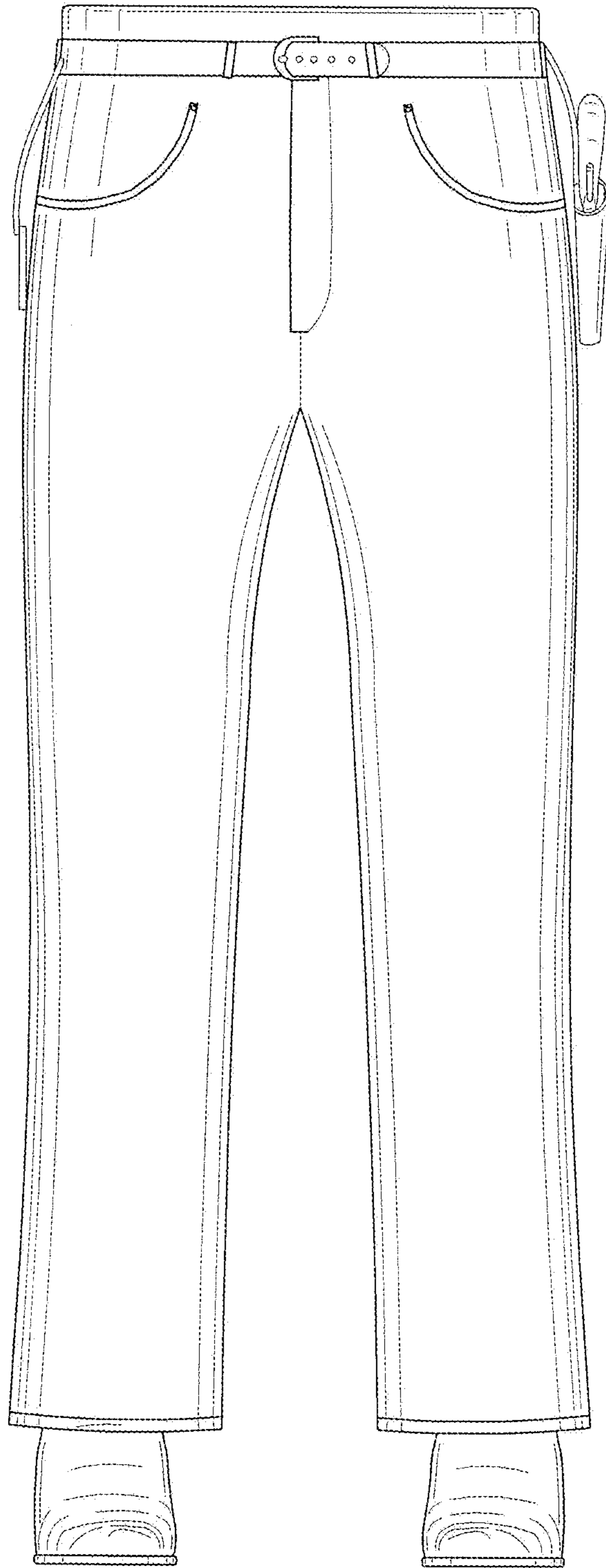

FIG. 1

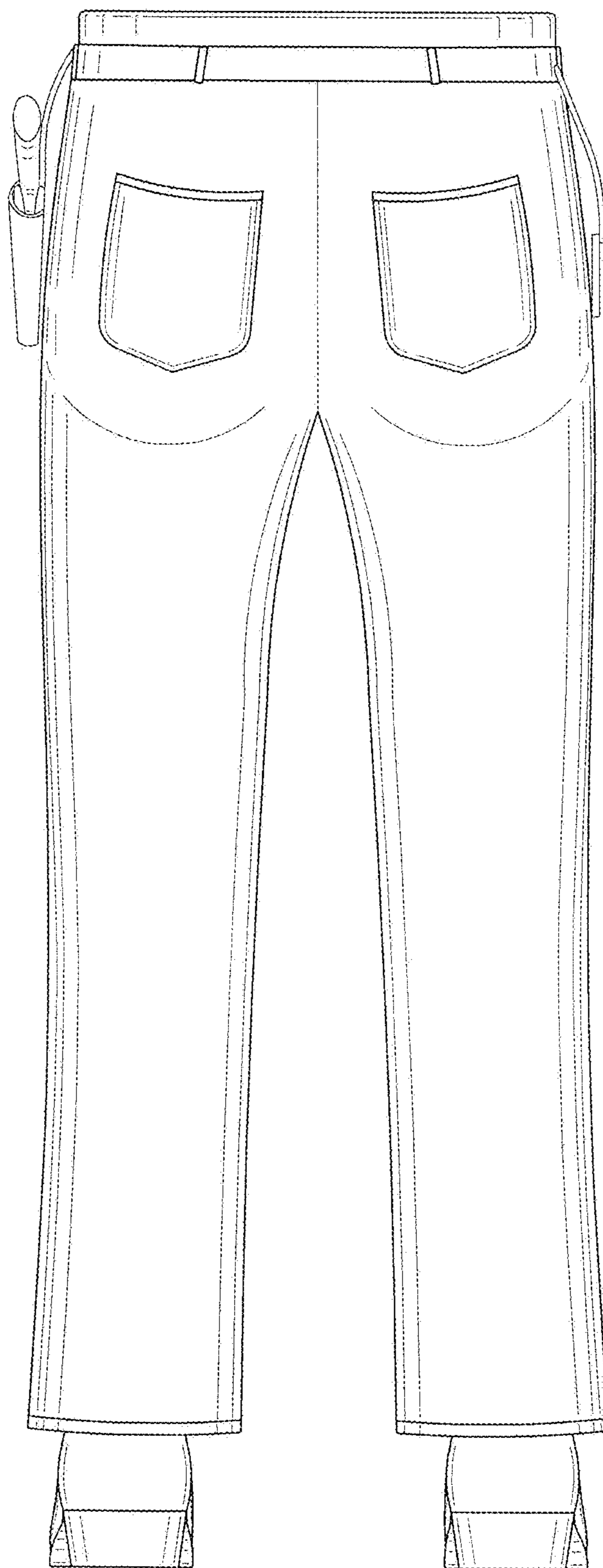

FIG. 2

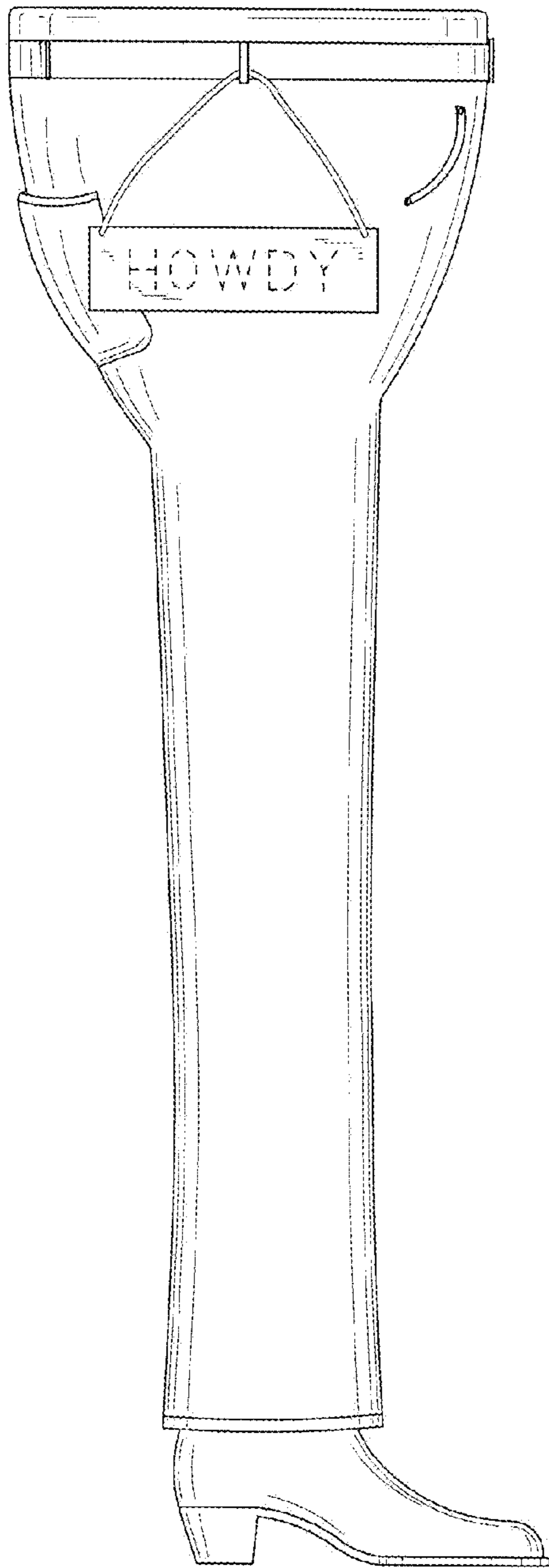

FIG. 3

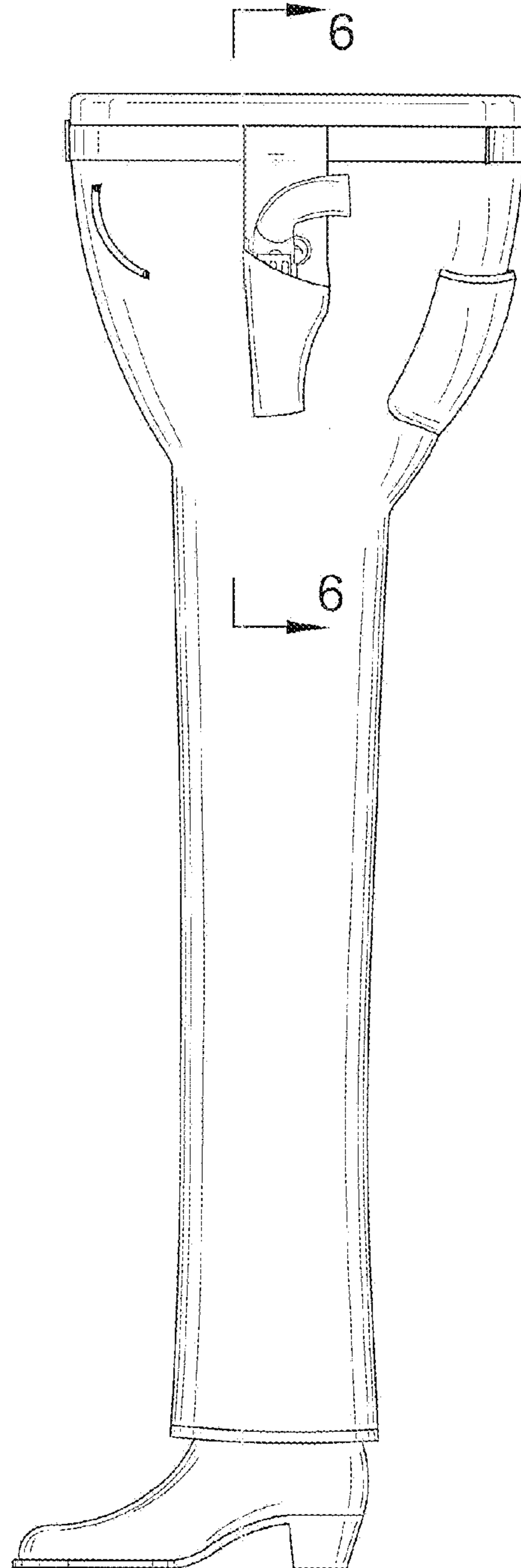

FIG. 4

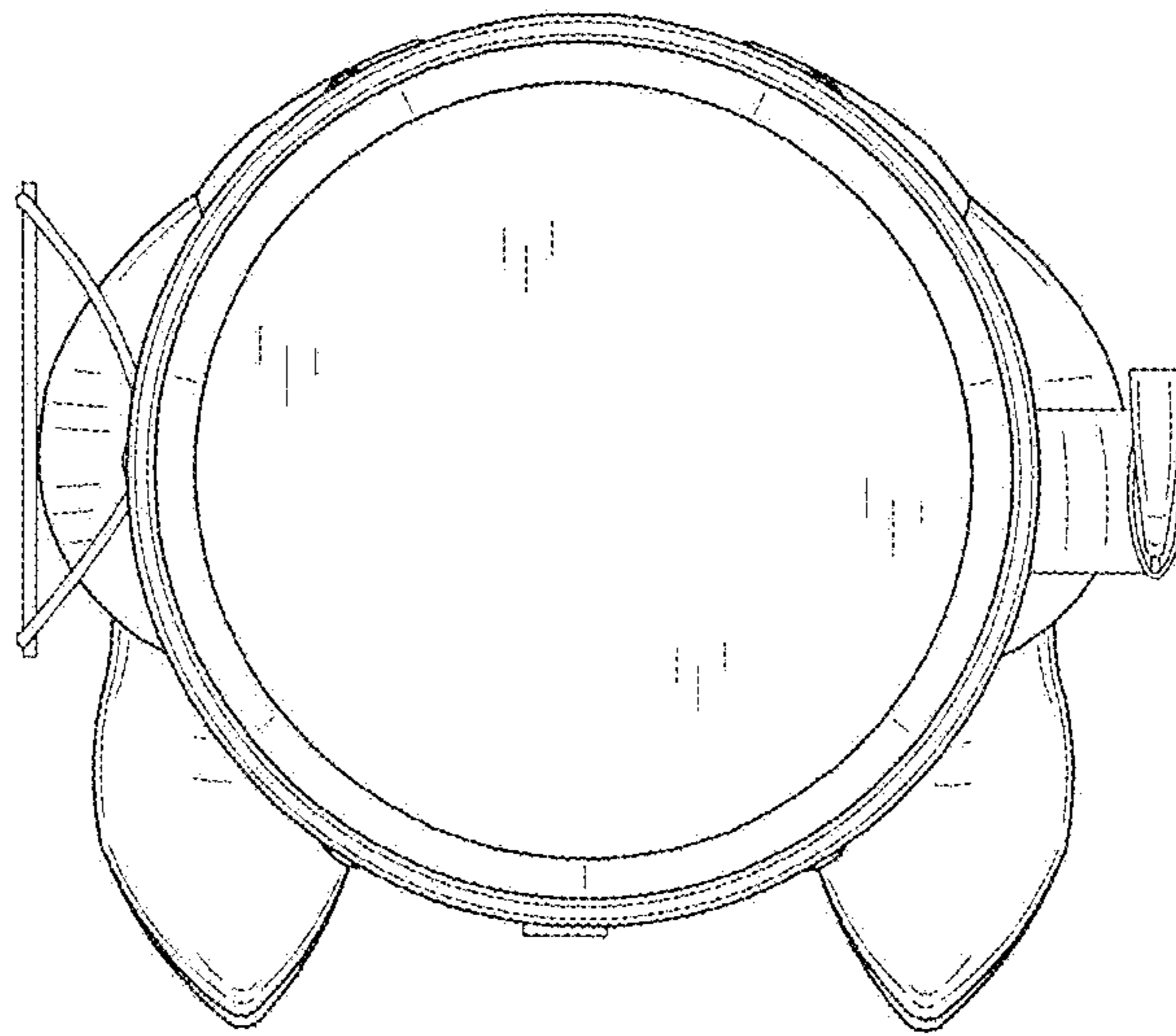

FIG. 5

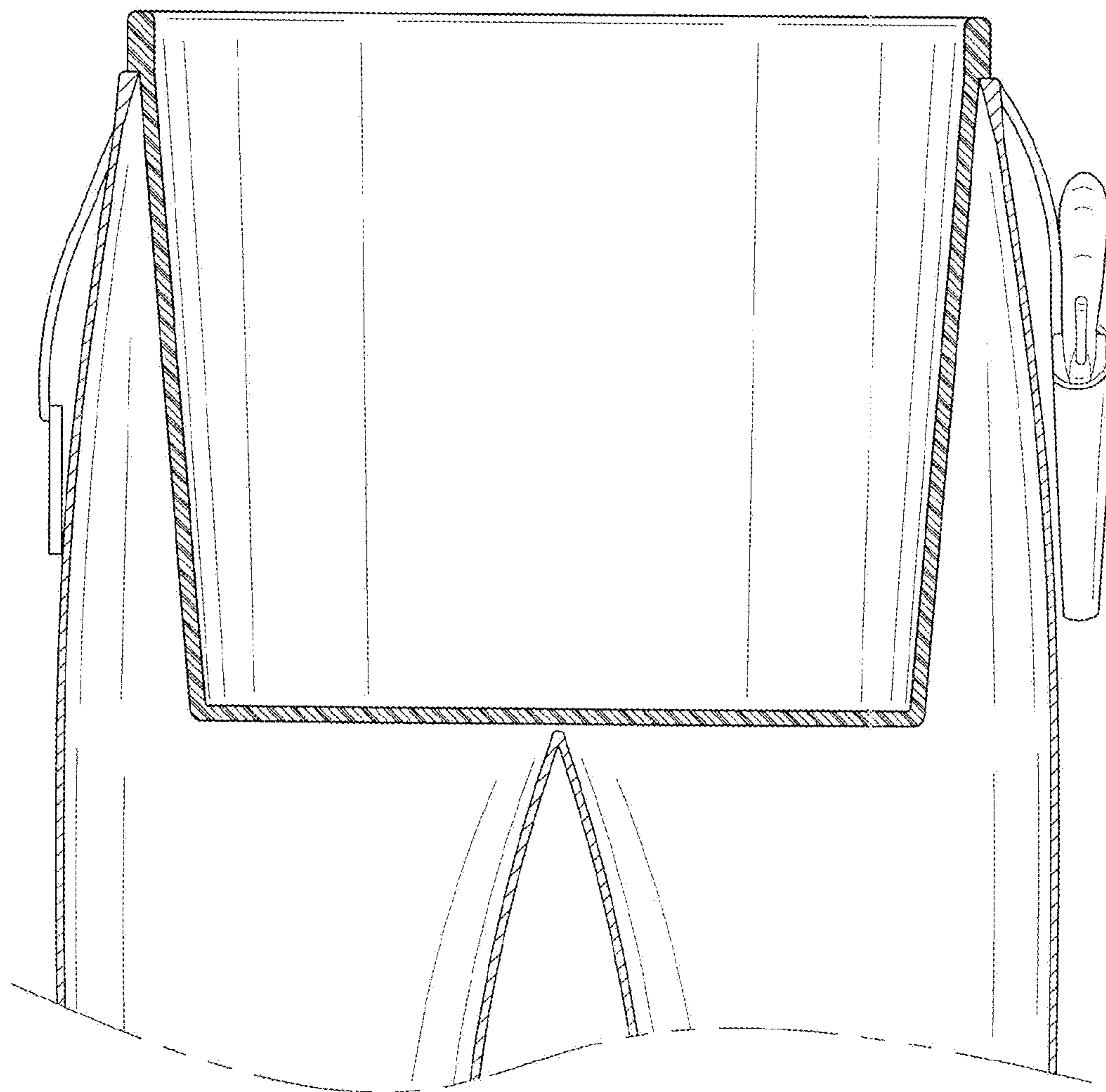

FIG. 6