



US00D726425S

(12) **United States Design Patent**  
**Chen**

(10) **Patent No.:** **US D726,425 S**

(45) **Date of Patent:** **\*\* Apr. 14, 2015**

(54) **ERGONOMIC BENCH**

(71) Applicant: **Samuel Chen**, Shanghai (CN)

(72) Inventor: **Samuel Chen**, Shanghai (CN)

(\*\*) Term: **14 Years**

(21) Appl. No.: **29/494,635**

(22) Filed: **Jun. 23, 2014**

(51) **LOC (10) Cl.** ..... **06-03**

(52) **U.S. Cl.**  
USPC ..... **D6/349**; D21/690

(58) **Field of Classification Search**

CPC ..... A47C 1/14; A47C 3/16-3/20; A47C 4/00;  
A47C 4/28; A47C 5/02; A47C 5/04; A47C  
5/043; A47C 7/00-7/006; A47C 7/02; A47C  
9/00; A47C 9/02; A47C 9/002; A47C 9/007;  
A47C 9/025; A47C 9/10; A47C 11/00;  
A47C 12/00; A47C 13/00; A47C 16/02  
USPC ..... D6/333, 335, 340, 344, 347, 349-355,  
D6/358, 360, 363-365, 381, 596, 601, 685,  
D6/687, 688.15, 688.27, 690, 691, 692.3,  
D6/708.16, 709, 709.2, 709.22, 711,  
D6/716-716.7, 717; D21/690

See application file for complete search history.

(56) **References Cited**

U.S. PATENT DOCUMENTS

D97,846 S \* 12/1935 Ely ..... D6/349  
D280,054 S \* 8/1985 Pedersen ..... D6/375  
D494,374 S \* 8/2004 Cagle ..... D6/361  
D526,498 S \* 8/2006 Jimenez et al. .... D6/361  
D560,259 S \* 1/2008 Heggdal ..... D21/690  
D648,551 S \* 11/2011 Clark ..... D6/361

\* cited by examiner

*Primary Examiner* — Susan Bennett Hattan

*Assistant Examiner* — Vy Koenig

(74) *Attorney, Agent, or Firm* — Clement Cheng

(57) **CLAIM**

The ornamental design for an ergonomic bench, as shown and described.

**DESCRIPTION**

FIG. 1 is a front perspective view;

FIG. 2 is a front view;

FIG. 3 is a rear view;

FIG. 4 is a left side view;

FIG. 5 is a right side view;

FIG. 6 is a top view; and,

FIG. 7 is a bottom view.

The broken lines shown represent environmental subject matter and form no part of the claimed design.

**1 Claim, 7 Drawing Sheets**

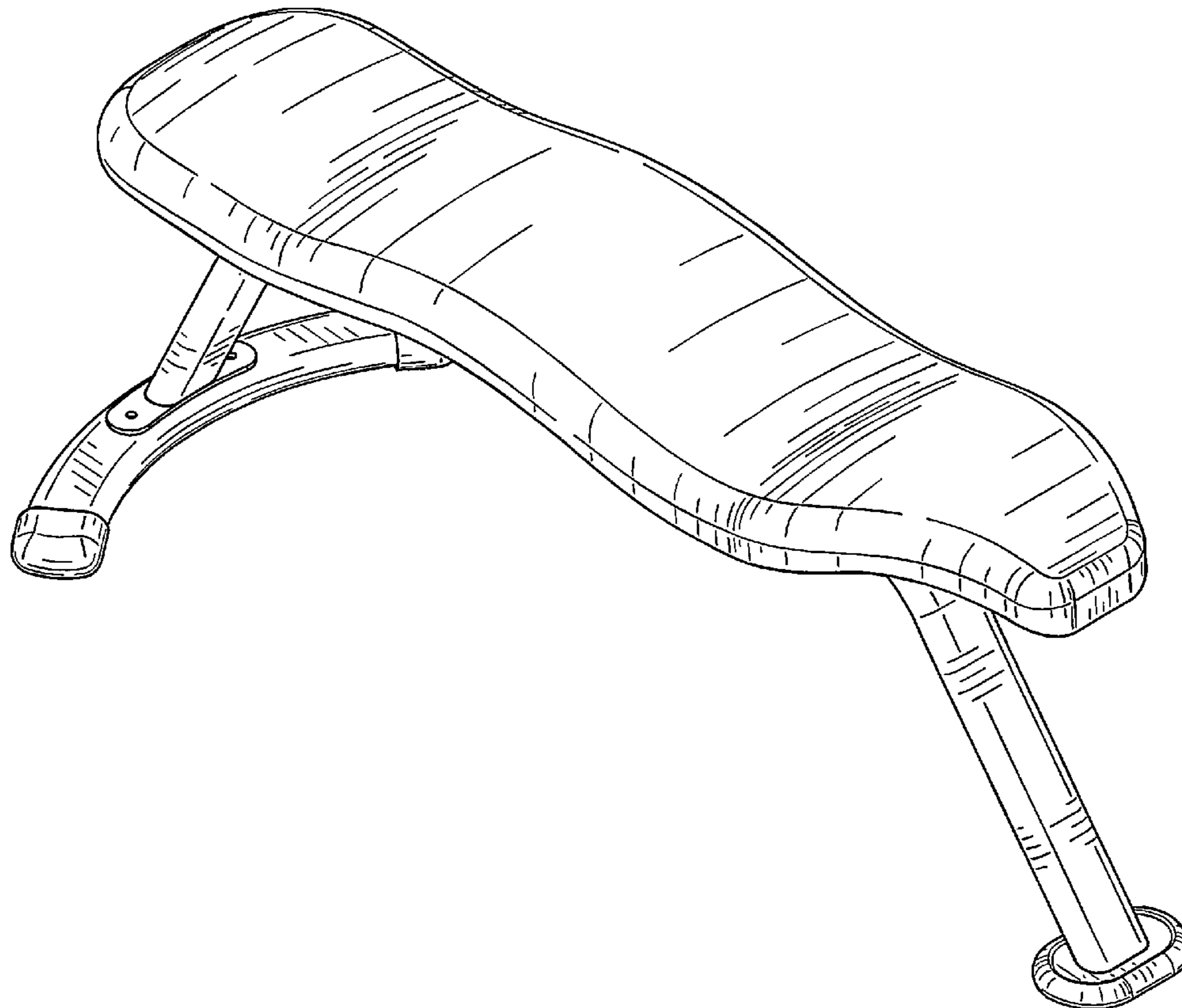

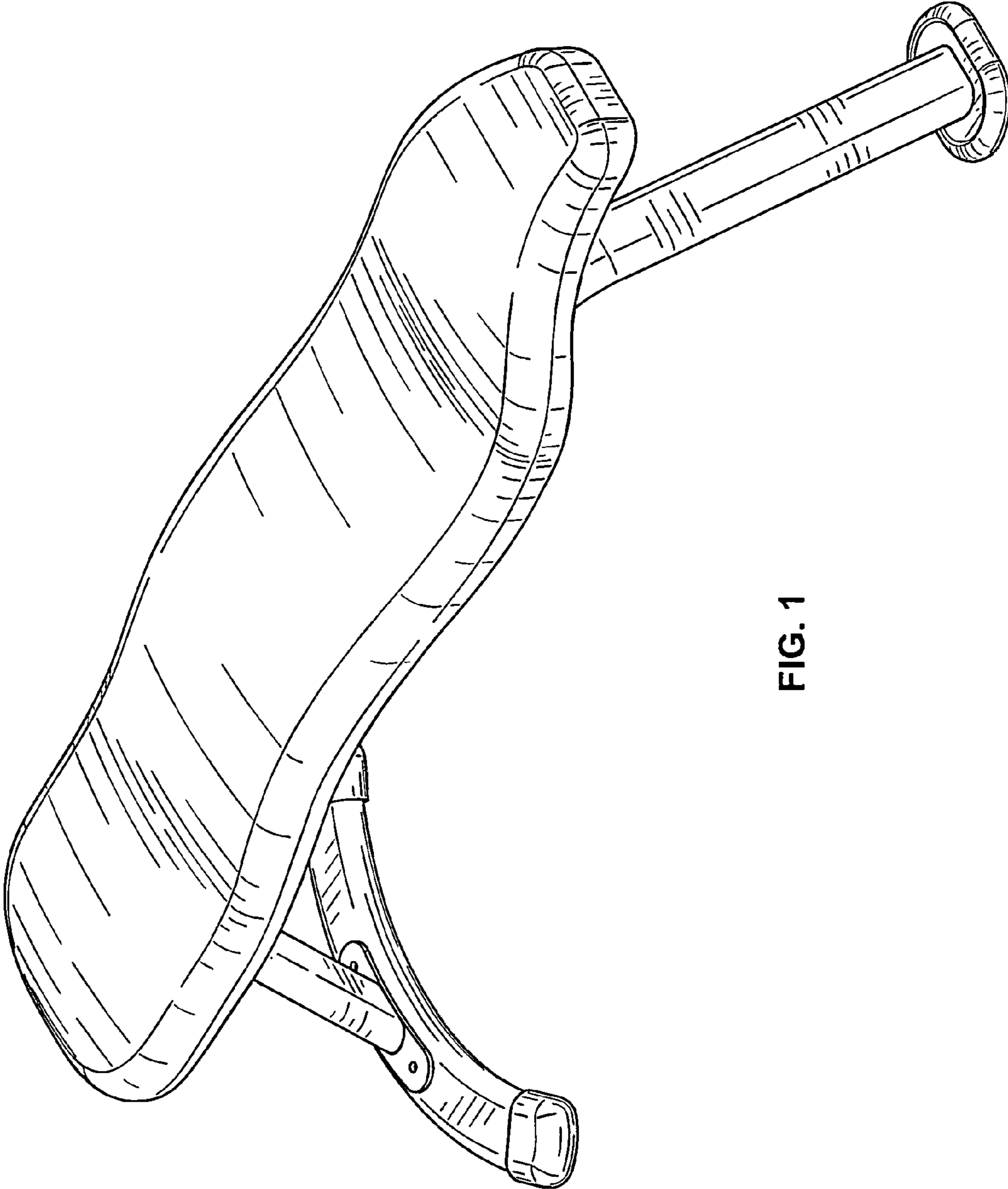

FIG. 1

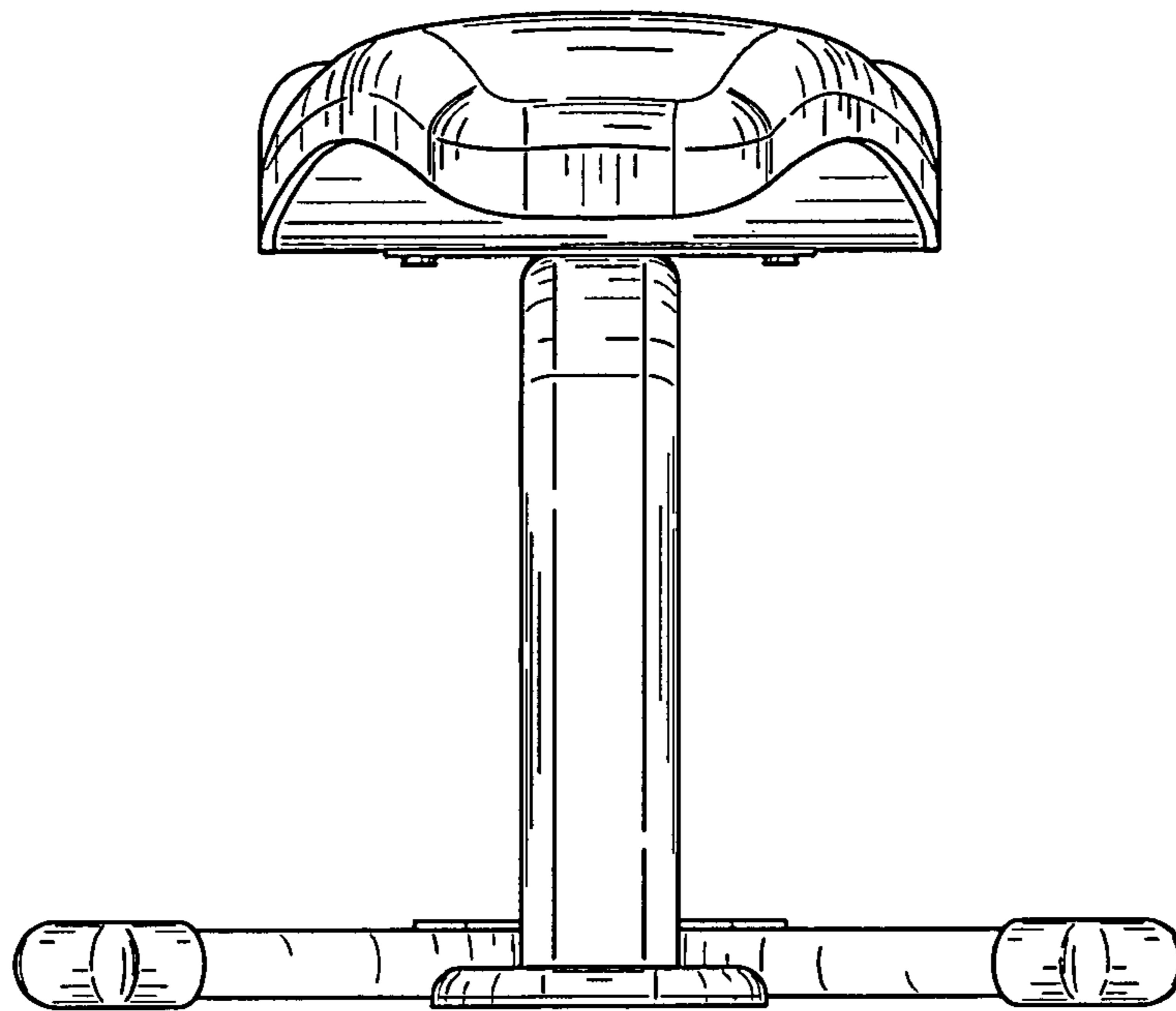

FIG. 2

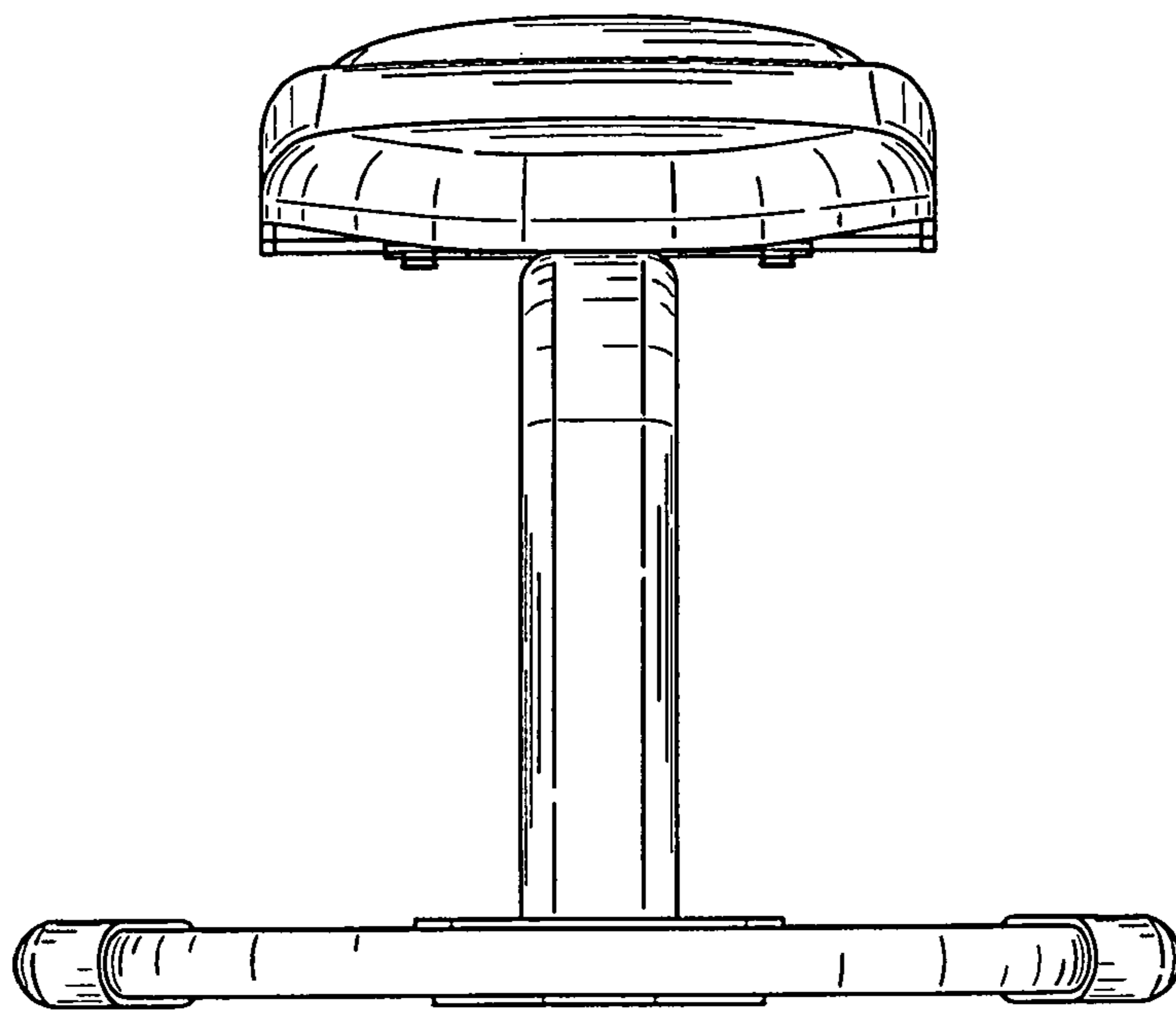

FIG. 3

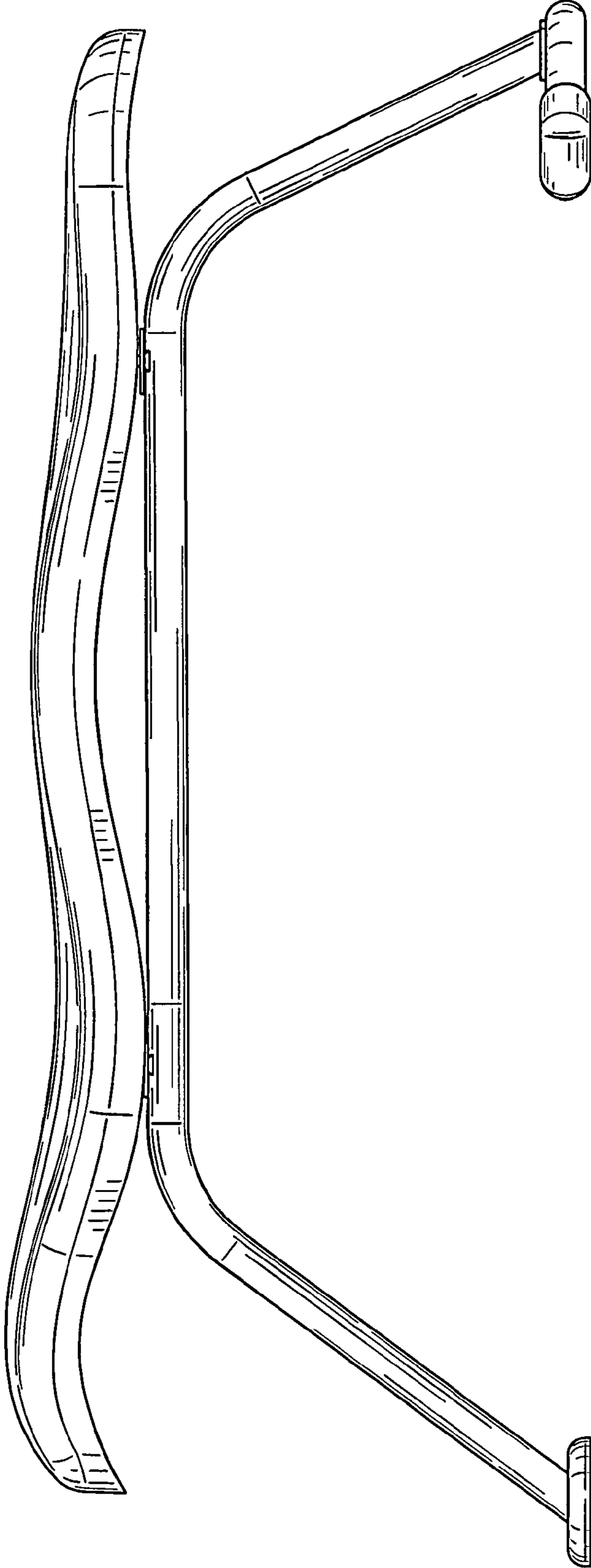

FIG. 4

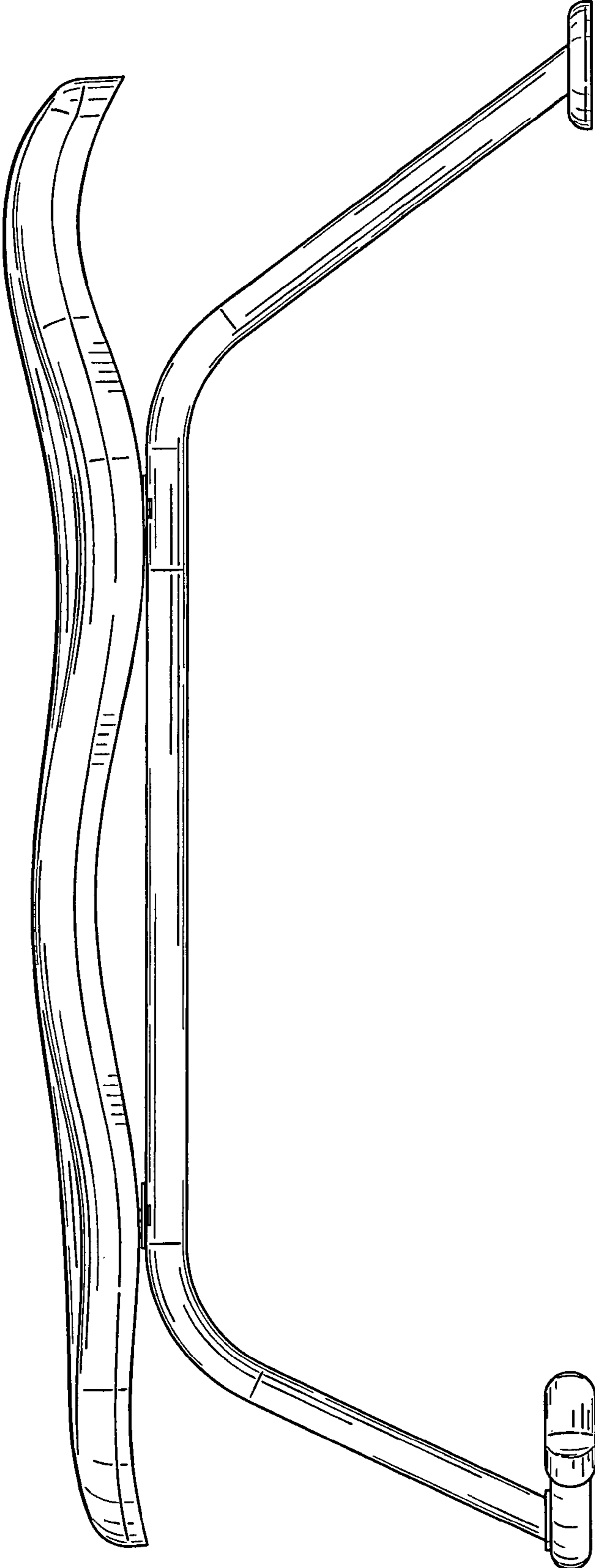

FIG. 5

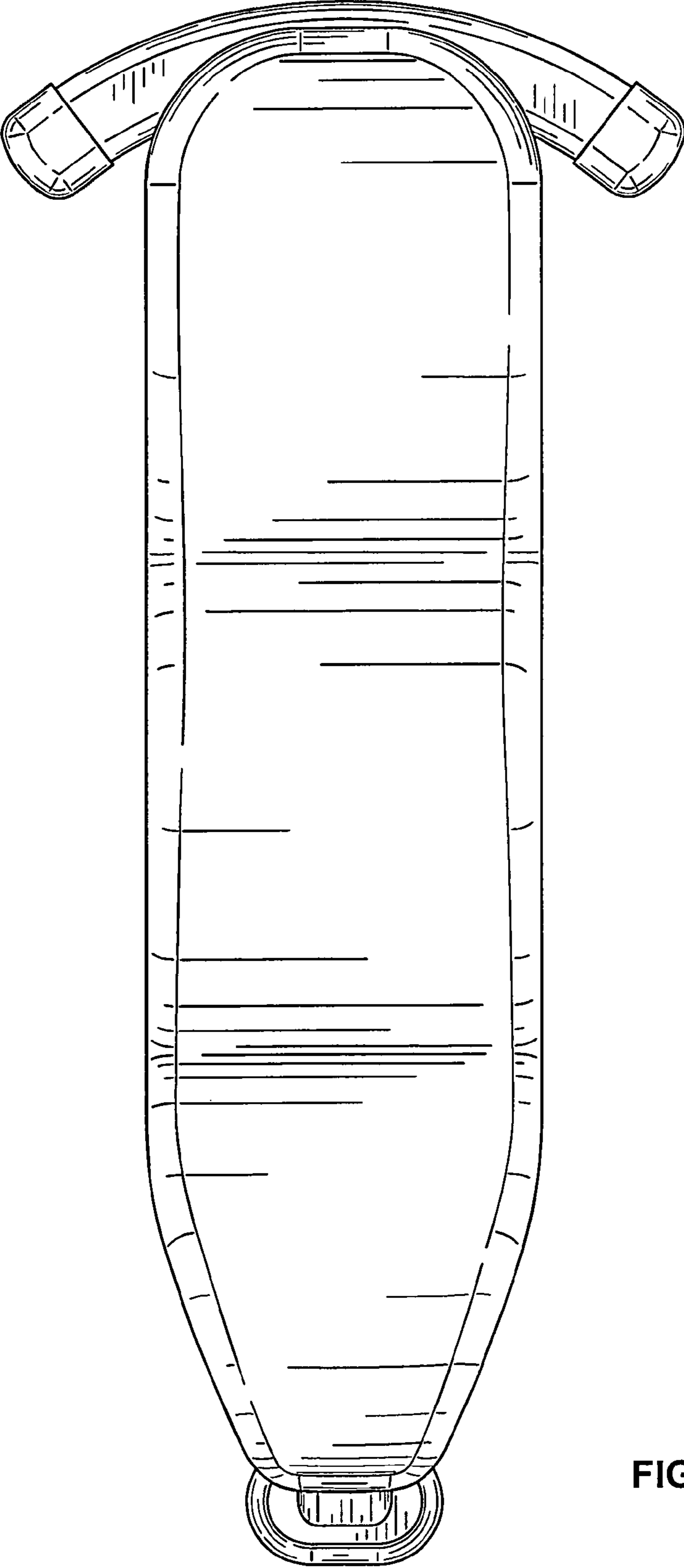

FIG. 6

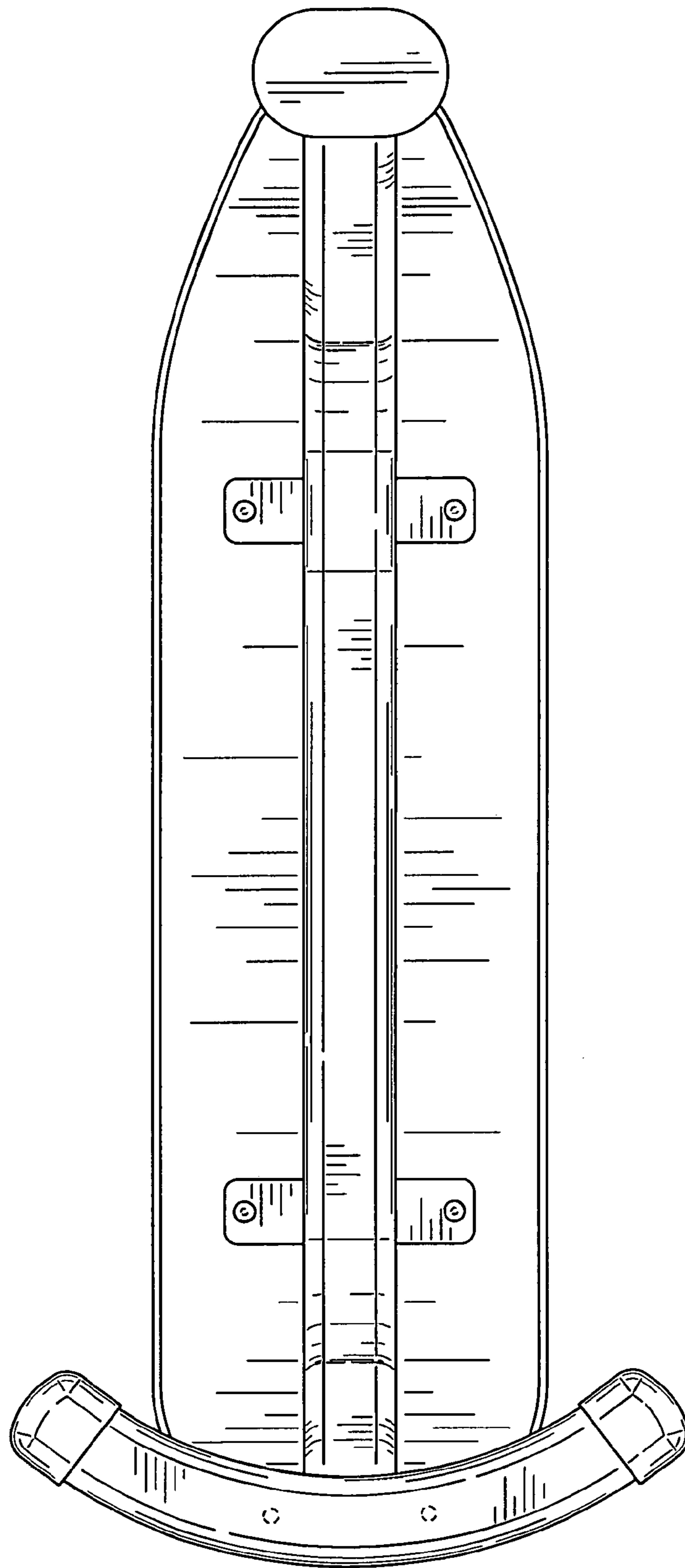

FIG. 7