



US00D726365S

(12) **United States Design Patent**  
**Weigensberg**

(10) **Patent No.:** **US D726,365 S**

(45) **Date of Patent:** **\*\* Apr. 7, 2015**

- (54) **MOUTHPIECE PLUG FOR ELECTRONIC CIGARETTE**
- (71) Applicant: **SIS Resources Ltd.**, Beit Shemesh (IL)
- (72) Inventor: **Aaron Arye Weigensberg**, Modiin (IL)
- (73) Assignee: **SIS Resources Ltd.**, Beit Shemesh (IL)
- (\*\*) Term: **14 Years**
- (21) Appl. No.: **29/456,109**
- (22) Filed: **May 29, 2013**
- (51) **LOC (10) Cl.** ..... **27-01**
- (52) **U.S. Cl.**  
USPC ..... **D27/101**
- (58) **Field of Classification Search**  
USPC ..... D27/100, 101, 103, 104, 105, 108, 170, D27/172, 174, 189, 190; D13/133, 139.1, D13/144, 171, 183; D19/65, 90; D8/310, D8/312, 331, 323, 387, 391; D7/393; D34/10; D23/262; 392/390, 394, 395  
See application file for complete search history.

(56) **References Cited**

**U.S. PATENT DOCUMENTS**

1,991,561 A	2/1935	Krantz et al.	
D204,203 S *	3/1966	Maffei .....	D8/310
3,560,690 A *	2/1971	Luce et al. ....	200/295
D298,506 S	11/1988	Lee	
D331,653 S *	12/1992	Stone .....	D34/11
D344,662 S	3/1994	Dittman	
5,499,427 A *	3/1996	Bowman .....	16/417
5,542,273 A	8/1996	Bednarz	
D388,316 S	12/1997	McDonough et al.	
D397,907 S *	9/1998	Dodane .....	D7/393
D414,207 S	9/1999	Wagner et al.	
D426,146 S *	6/2000	Bruns et al. ....	D8/387
D434,962 S *	12/2000	Short .....	D8/310
D437,209 S	2/2001	McDonough et al.	
D454,591 S	3/2002	Vidmar et al.	
D470,818 S	2/2003	Cheng	
D528,192 S *	9/2006	Nicholson .....	D23/260

D545,664 S *	7/2007	Fields .....	D8/310
D551,937 S *	10/2007	Krumpe et al. ....	D8/310
D558,673 S	1/2008	Easley	
D559,073 S *	1/2008	Krumpe et al. ....	D8/310
D565,927 S *	4/2008	Krumpe .....	D8/310
D579,307 S	10/2008	Himmelburger	
D594,735 S	6/2009	Hofer	
D623,506 S *	9/2010	Ghatikar et al. ....	D8/382
D623,507 S	9/2010	Bowen, III	
D633,870 S	3/2011	Thommes	
D639,650 S	6/2011	Summers	
D642,548 S	8/2011	Bowen, III	
D670,471 S *	11/2012	Brown et al. ....	D34/10
D676,877 S	2/2013	Drenth et al.	
D691,020 S *	10/2013	Wiese .....	D8/323
D699,554 S	2/2014	David	
D709,995 S	7/2014	Crabbe et al.	
D712,242 S *	9/2014	Deneve .....	D8/391
2010/0139046 A1 *	6/2010	Daniels et al. ....	16/414

**OTHER PUBLICATIONS**

Notice of Allowance for corresponding U.S. Appl. No. 29/456,108 dated Nov. 21, 2014.

\* cited by examiner

*Primary Examiner* — Barbara Fox

*Assistant Examiner* — Chelsea Sealey

(74) *Attorney, Agent, or Firm* — Harness, Dickey & Pierce

(57) **CLAIM**

I claim the ornamental design for a mouthpiece plug for electronic cigarette, as shown and described.

**DESCRIPTION**

FIG. 1 is a side elevation view of a mouthpiece plug for electronic cigarette showing my new design; FIG. 2 is a top plan view thereof; FIG. 3 is a bottom plan view thereof; FIG. 4 is a perspective view thereof; and, FIG. 5 is a perspective view thereof. The broken lines depict environmental subject matter only and form no part of the claimed design.

**1 Claim, 3 Drawing Sheets**

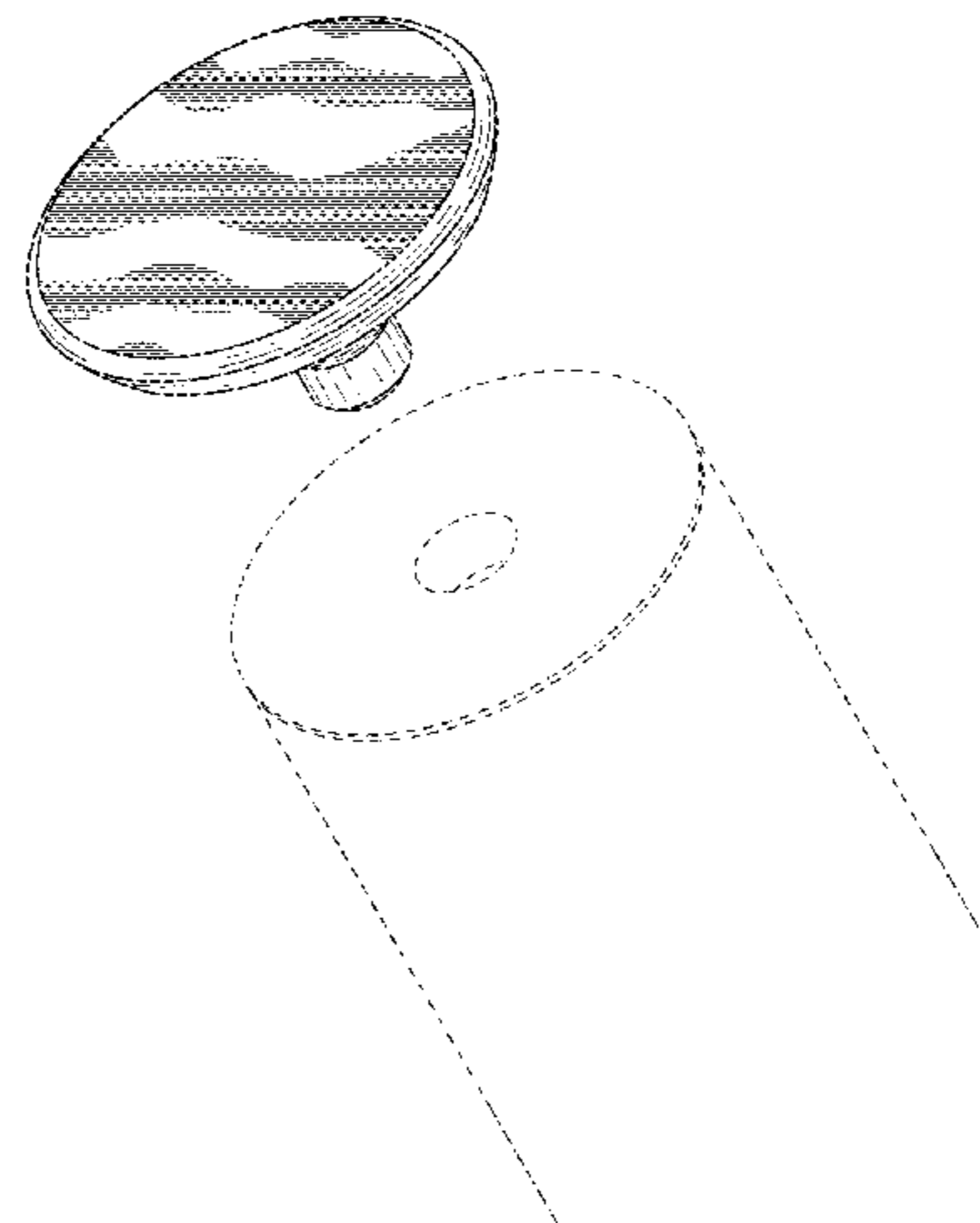
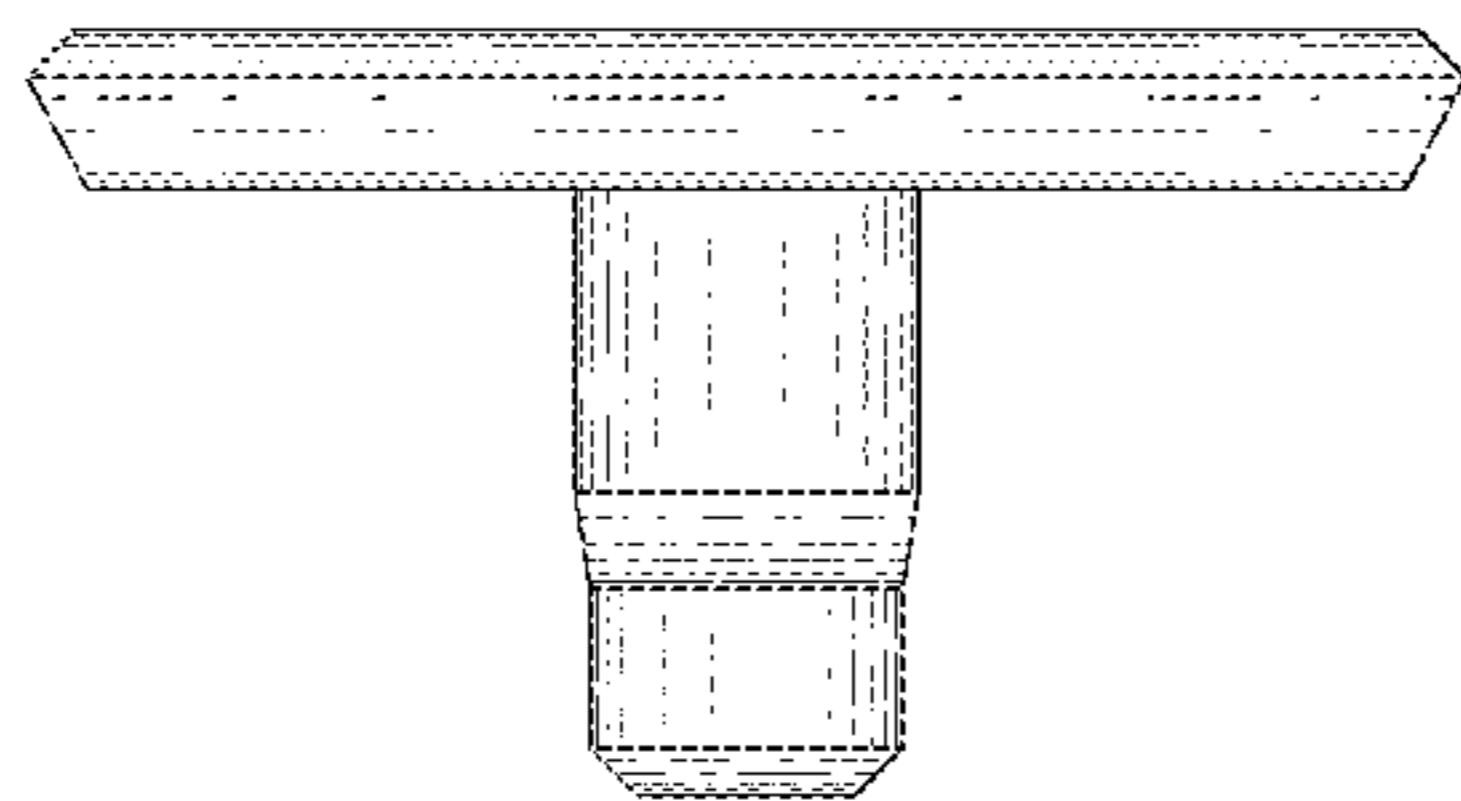

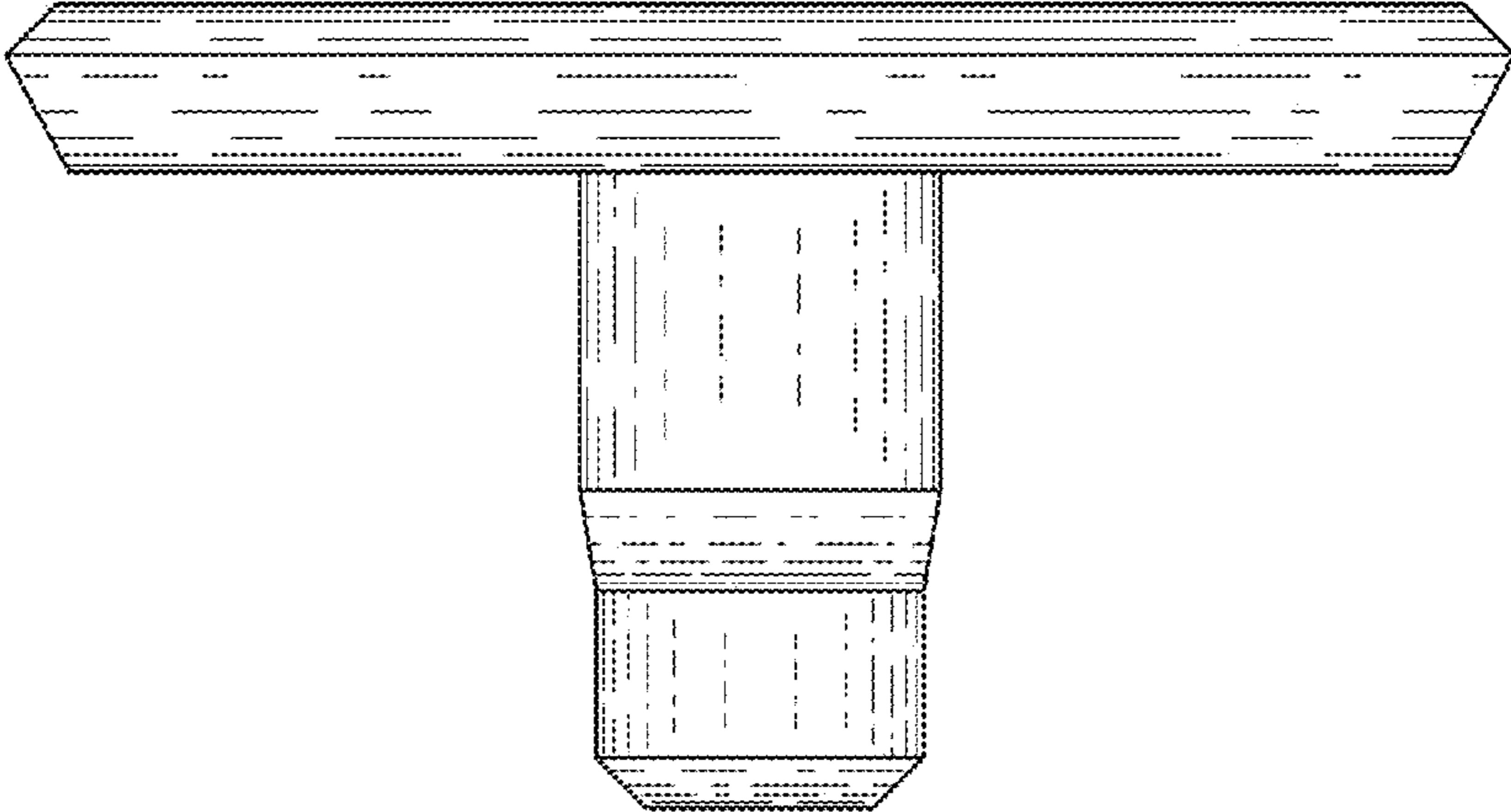

Fig. 1

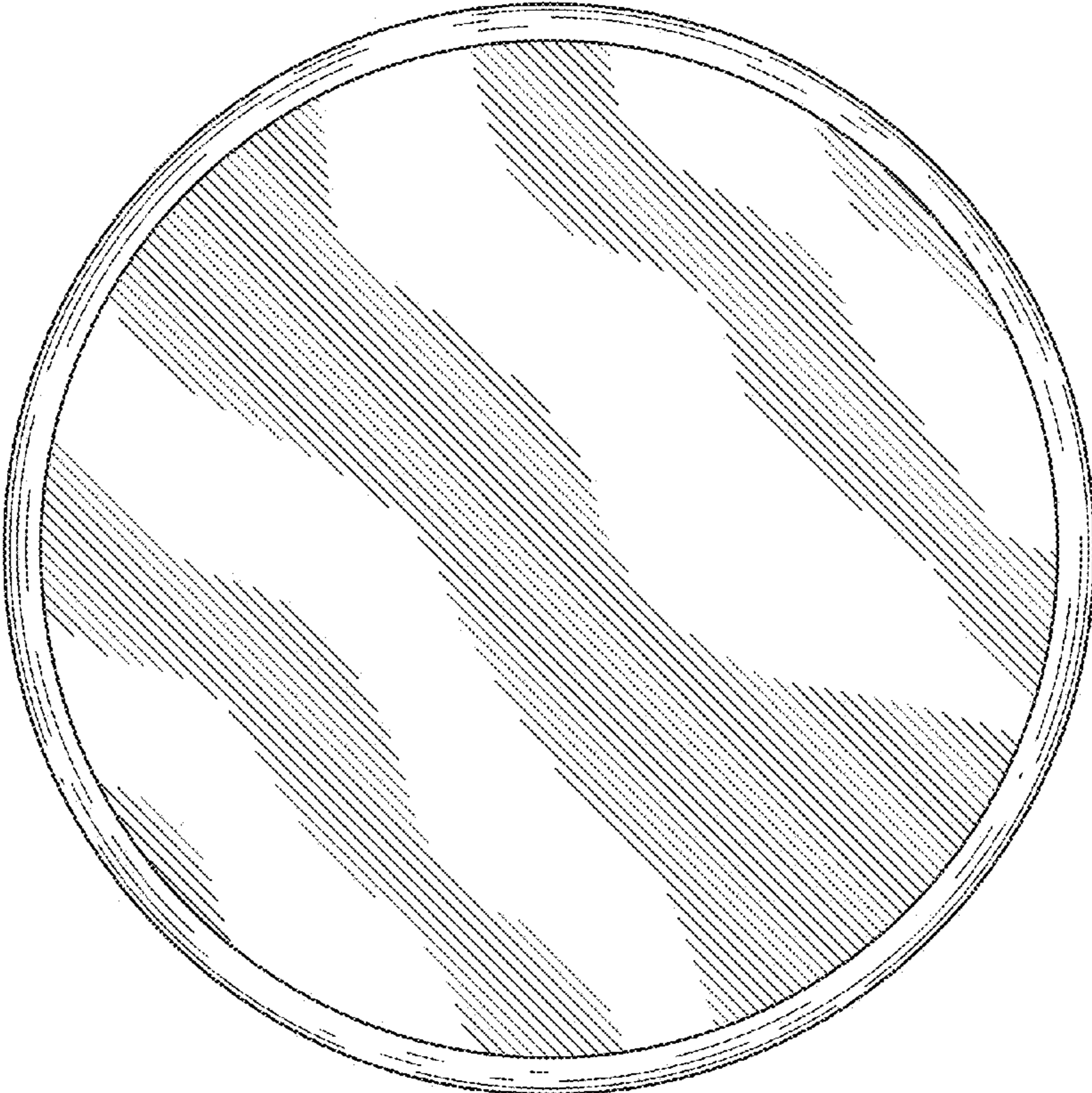

Fig. 2

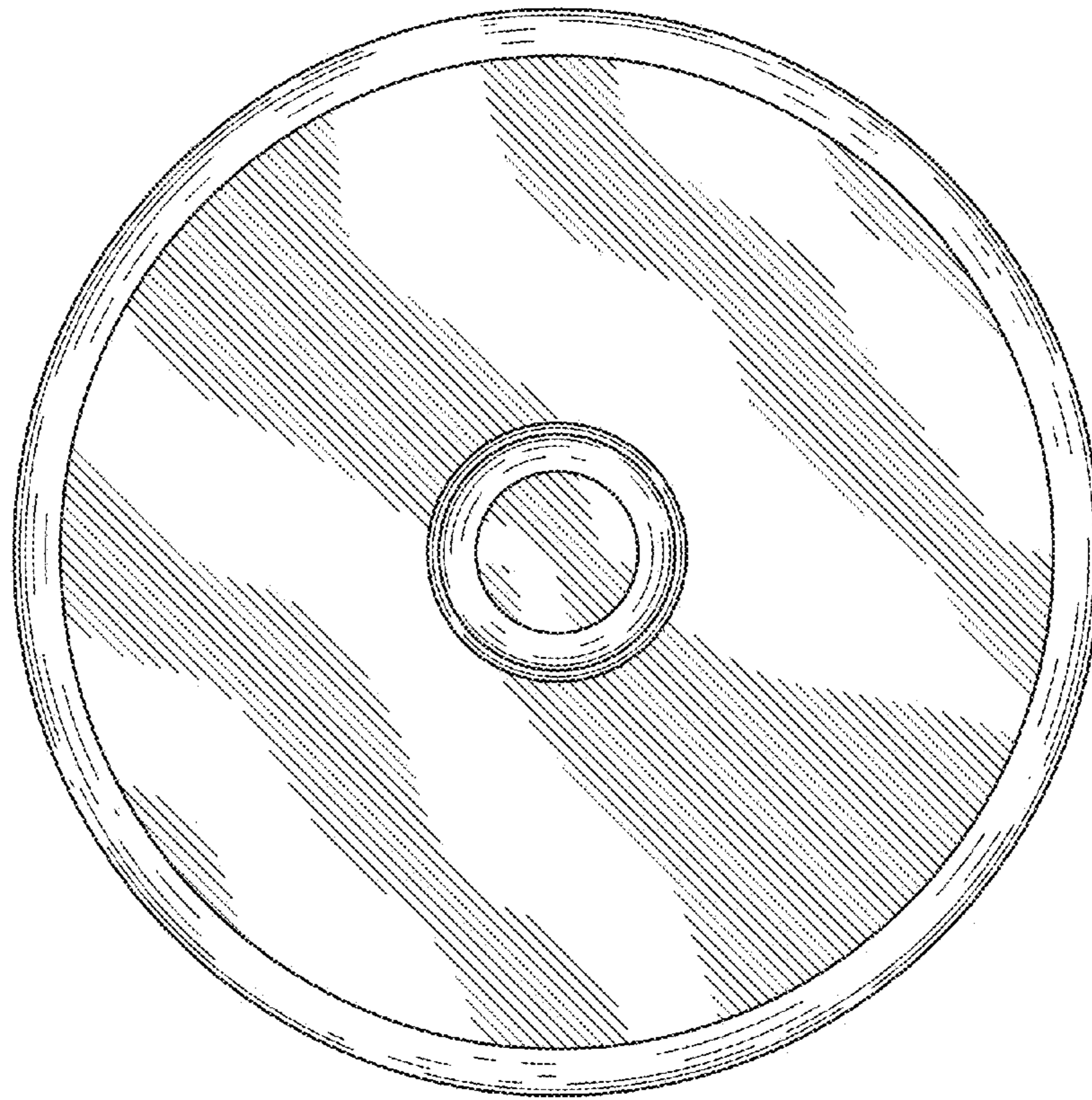

Fig. 3

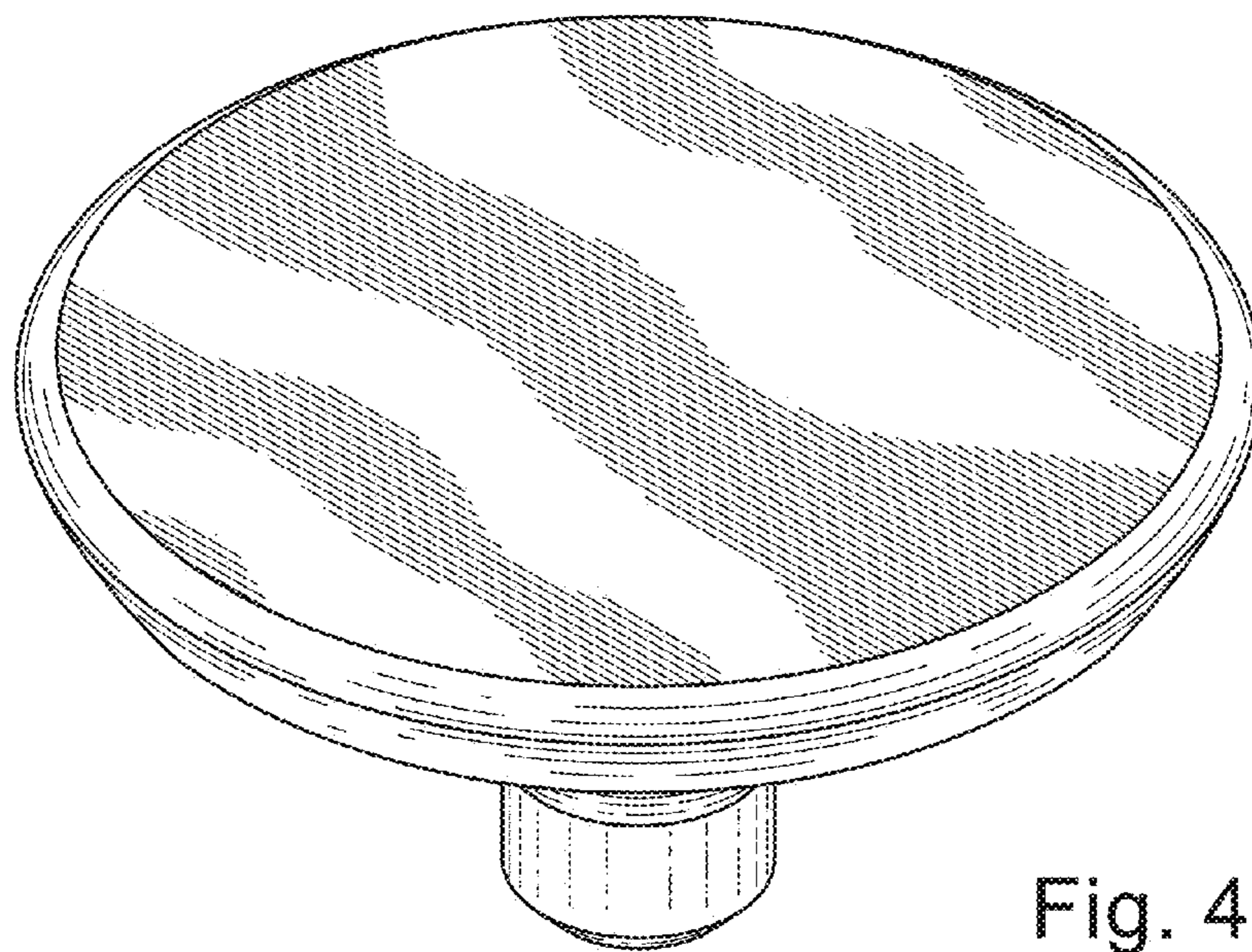

Fig. 4

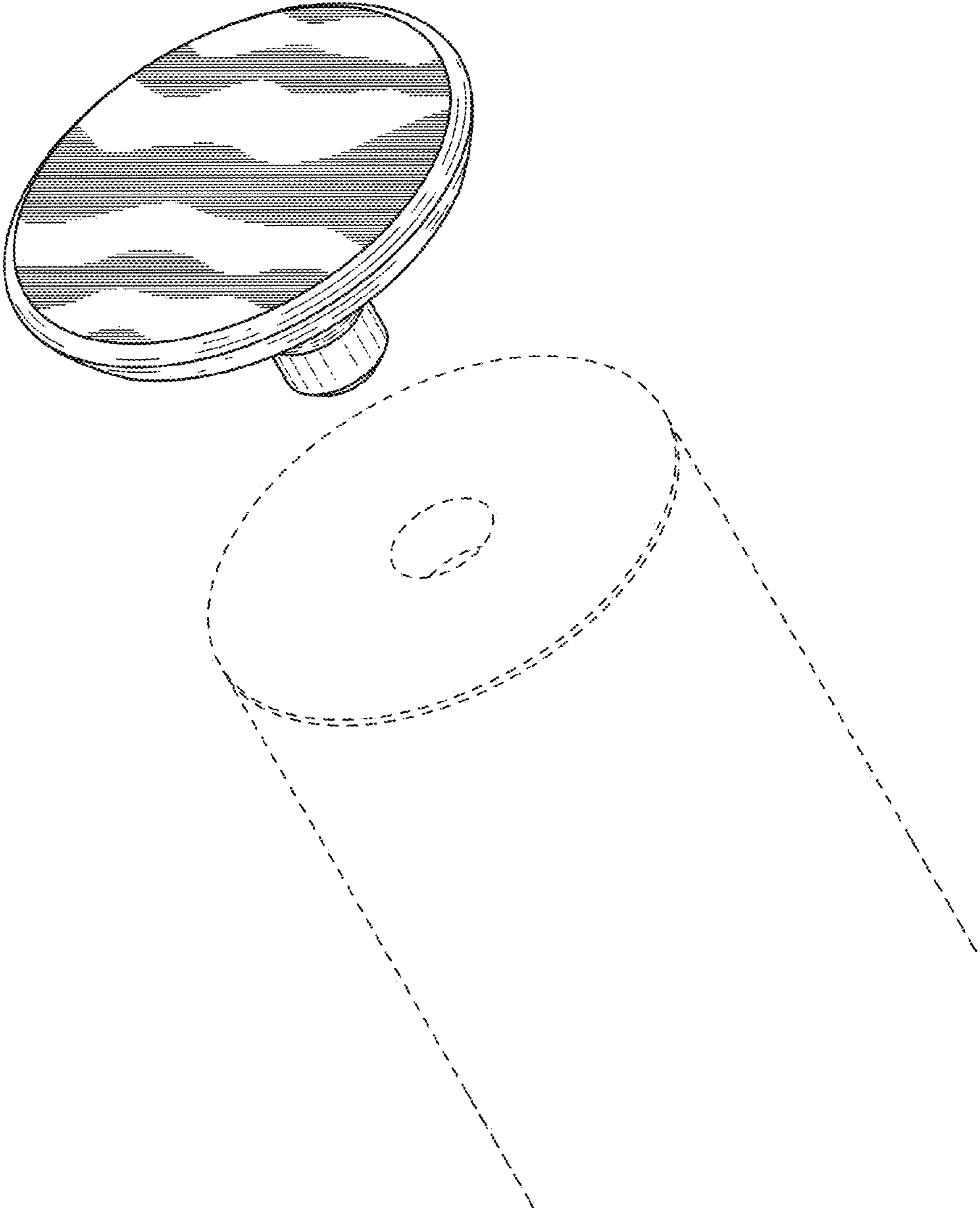

Fig. 5