



US00D726284S

(12) **United States Design Patent**
Huang

(10) **Patent No.:** **US D726,284 S**
(45) **Date of Patent:** **** Apr. 7, 2015**

(54) **FAUCET**

(71) Applicant: **Li-Chen Huang**, Changhua (TW)

(72) Inventor: **Li-Chen Huang**, Changhua (TW)

(73) Assignee: **Alexander Yeh Industry Co. Ltd.**,
Changhua (TW)

(**) Term: **14 Years**

(21) Appl. No.: **29/482,218**

(22) Filed: **Feb. 14, 2014**

(51) **LOC (10) Cl.** **23-01**

(52) **U.S. Cl.**
USPC **D23/257**

(58) **Field of Classification Search**
USPC D23/238, 241–243, 249, 255, 257;
4/675–678; 137/801

See application file for complete search history.

(56) **References Cited**

U.S. PATENT DOCUMENTS

D411,874 S * 7/1999 Ko D23/255
D428,971 S * 8/2000 Milrud et al. D23/255
D590,051 S * 4/2009 Huang D23/255

D710,975 S * 8/2014 Huang D23/255

* cited by examiner

Primary Examiner — Robert Delehanty

(74) *Attorney, Agent, or Firm* — Che-Yang Chen; Law
Office of Michael Chen

(57) **CLAIM**

The ornamental design for a faucet, as shown and described.

DESCRIPTION

FIG. 1 is a perspective view of a faucet showing my new
design;

FIG. 2 is a front elevational view thereof;

FIG. 3 is a rear elevational view thereof;

FIG. 4 is a left side elevational view thereof;

FIG. 5 is a right side elevational view thereof;

FIG. 6 is a top plan view thereof;

FIG. 7 is a bottom plan view thereof; and,

FIG. 8 is a perspective schematic view illustrating an appli-
cation of a faucet showing my design.

The broken lines in the drawings are for showing the center
portions of the underside of the spout and the interior of the
back side, which form no part of the claimed design.

The broken lines in FIG. 8 are for illustrative purposes only
and form no part of the claimed design.

1 Claim, 5 Drawing Sheets

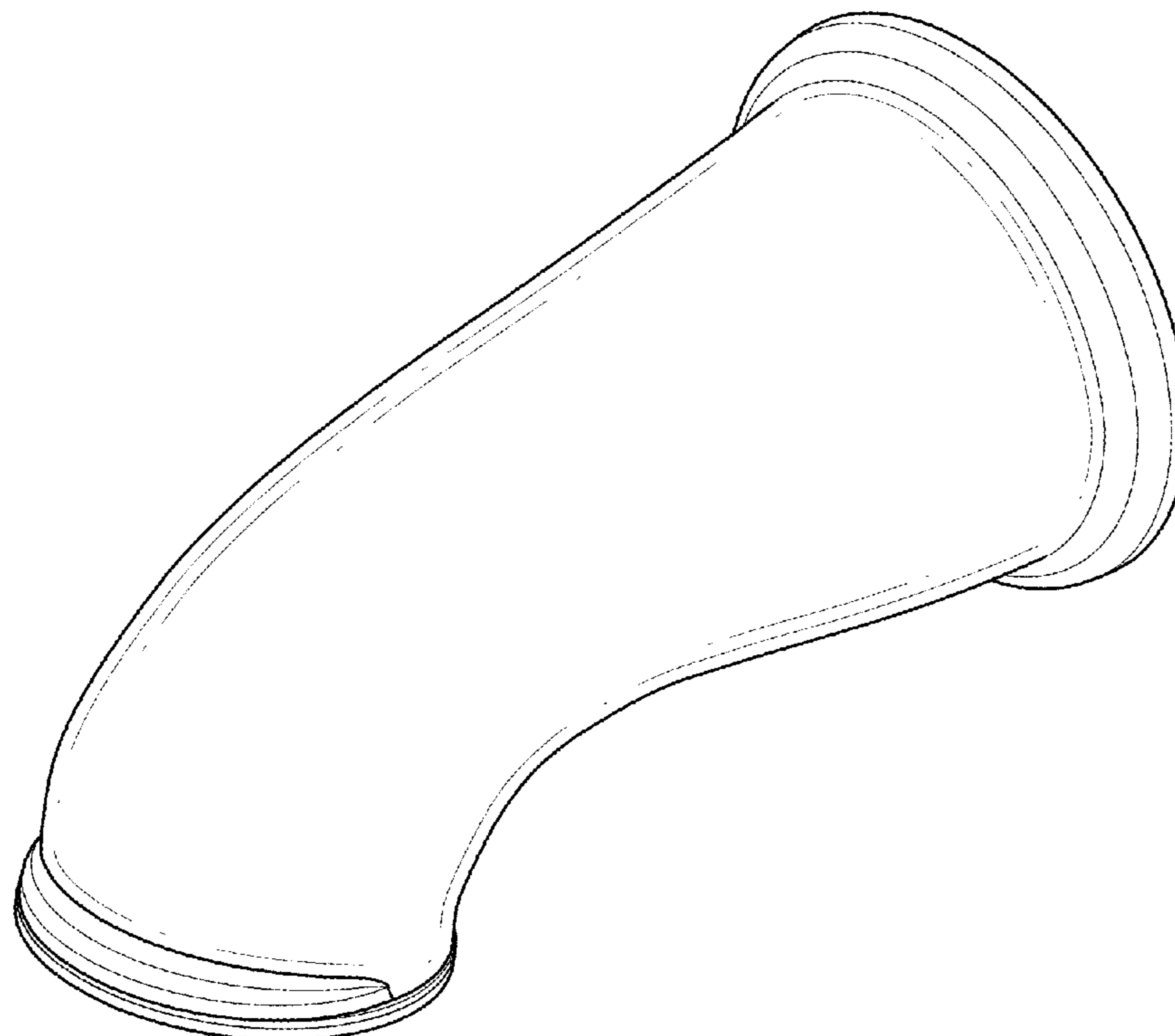

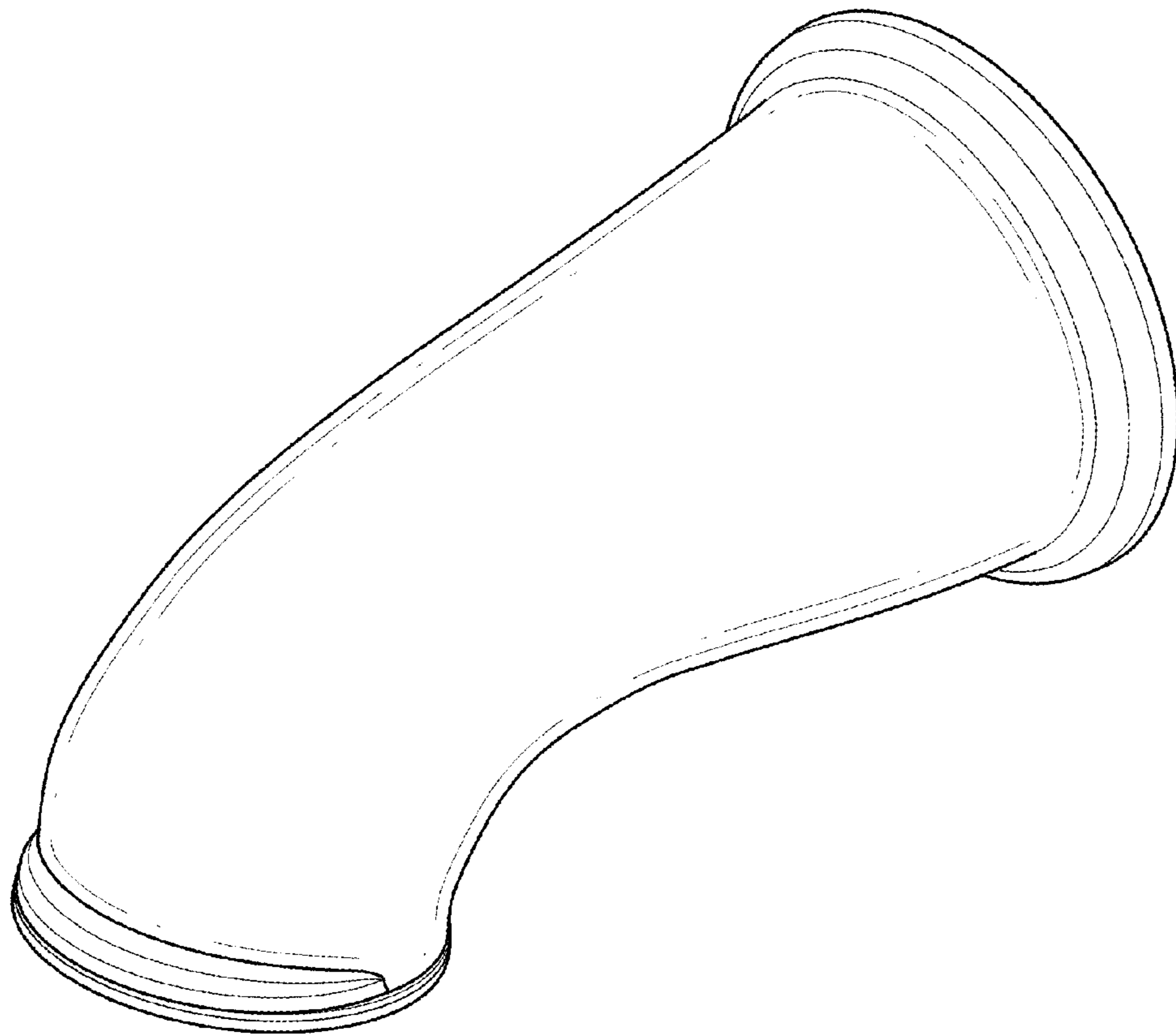

FIG. 1

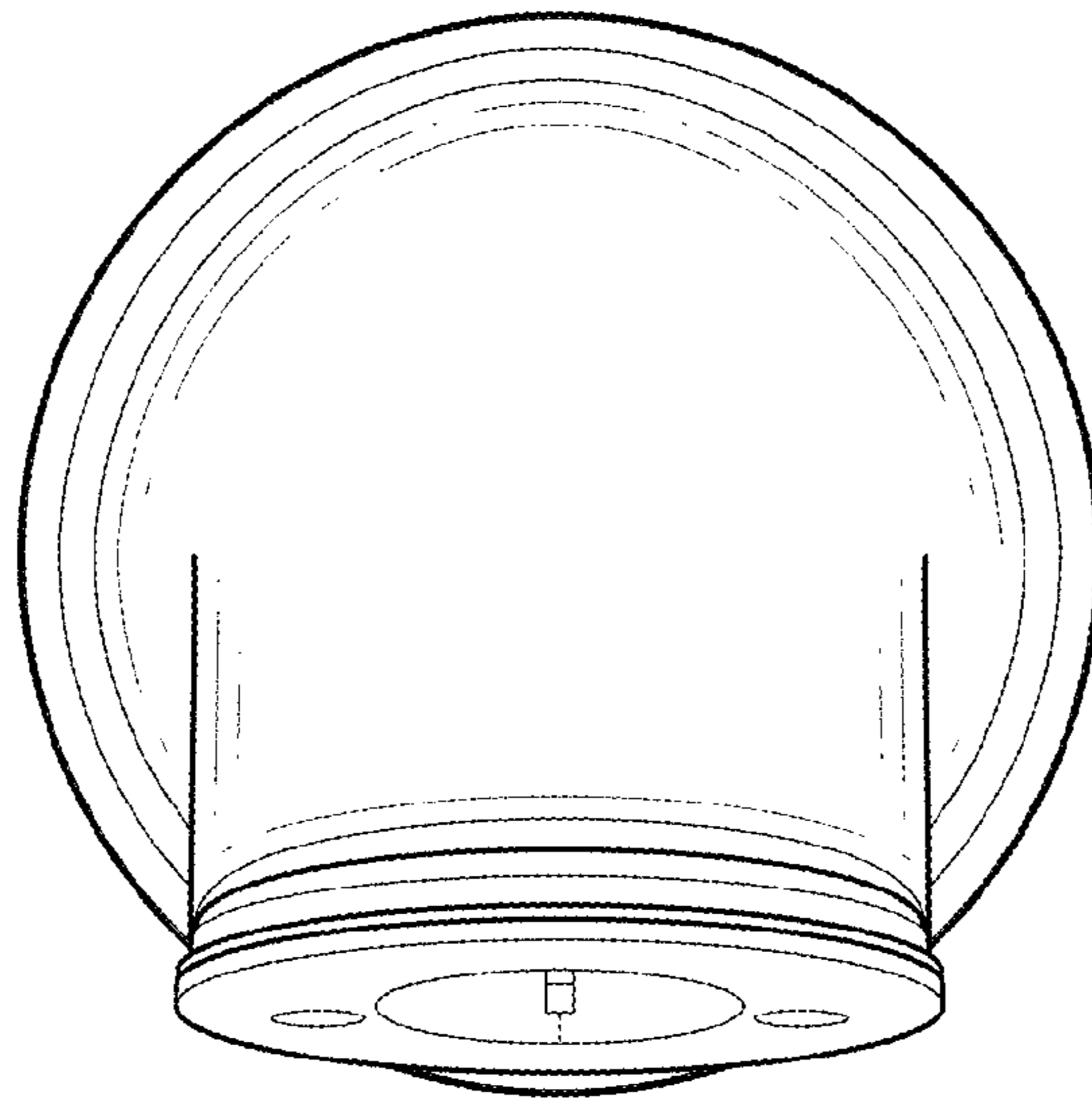

FIG. 2

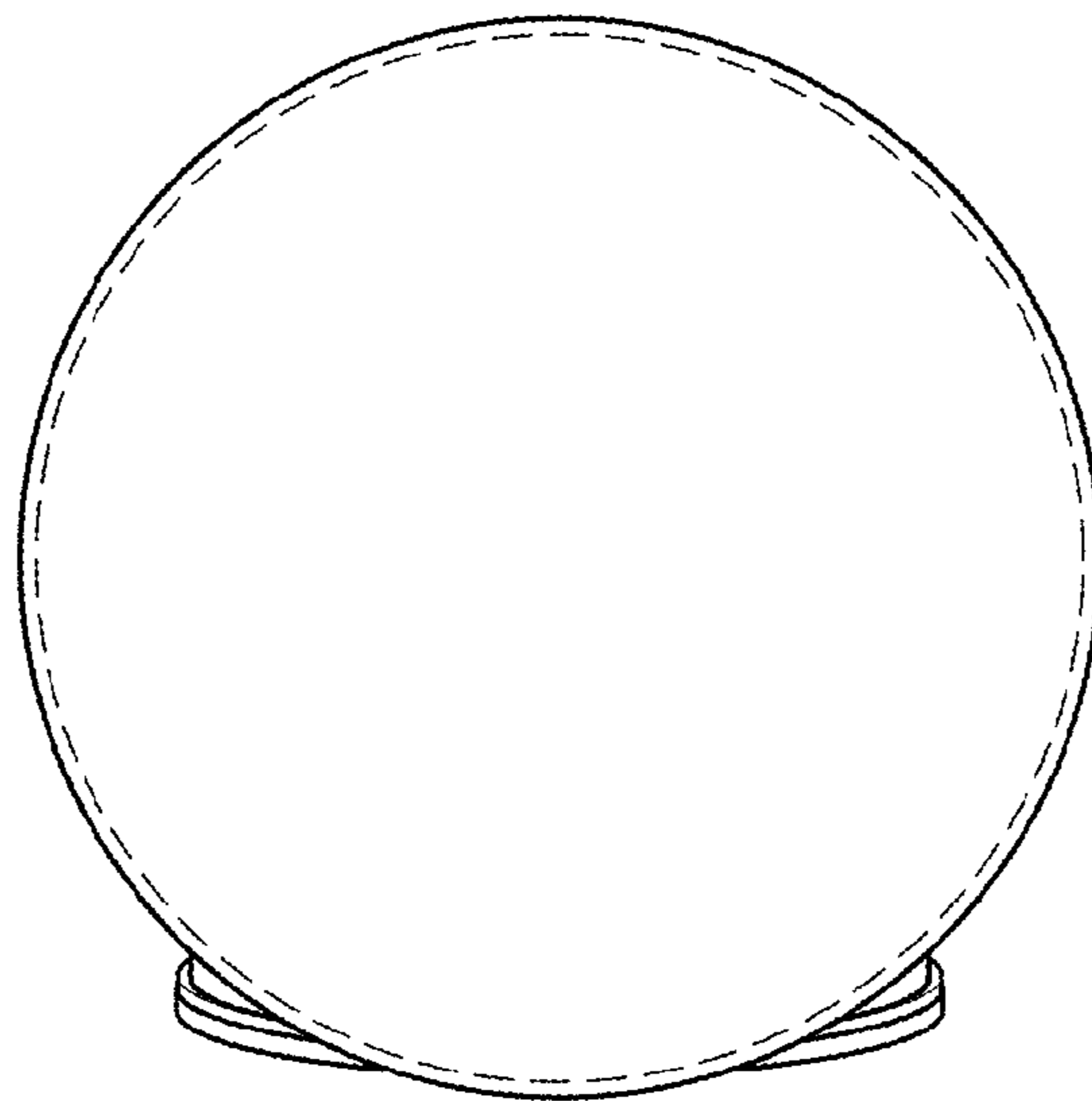

FIG. 3

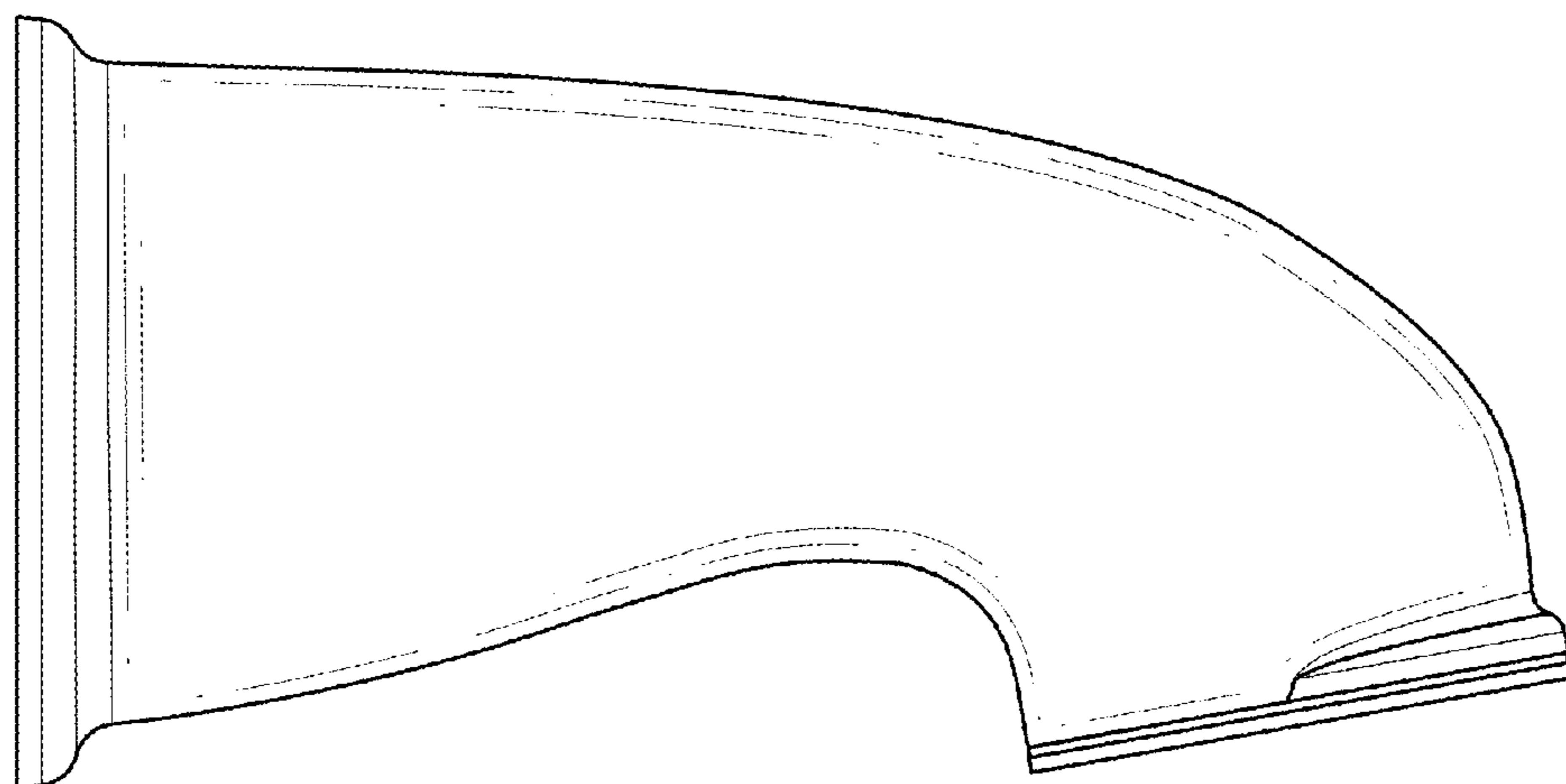

FIG.4

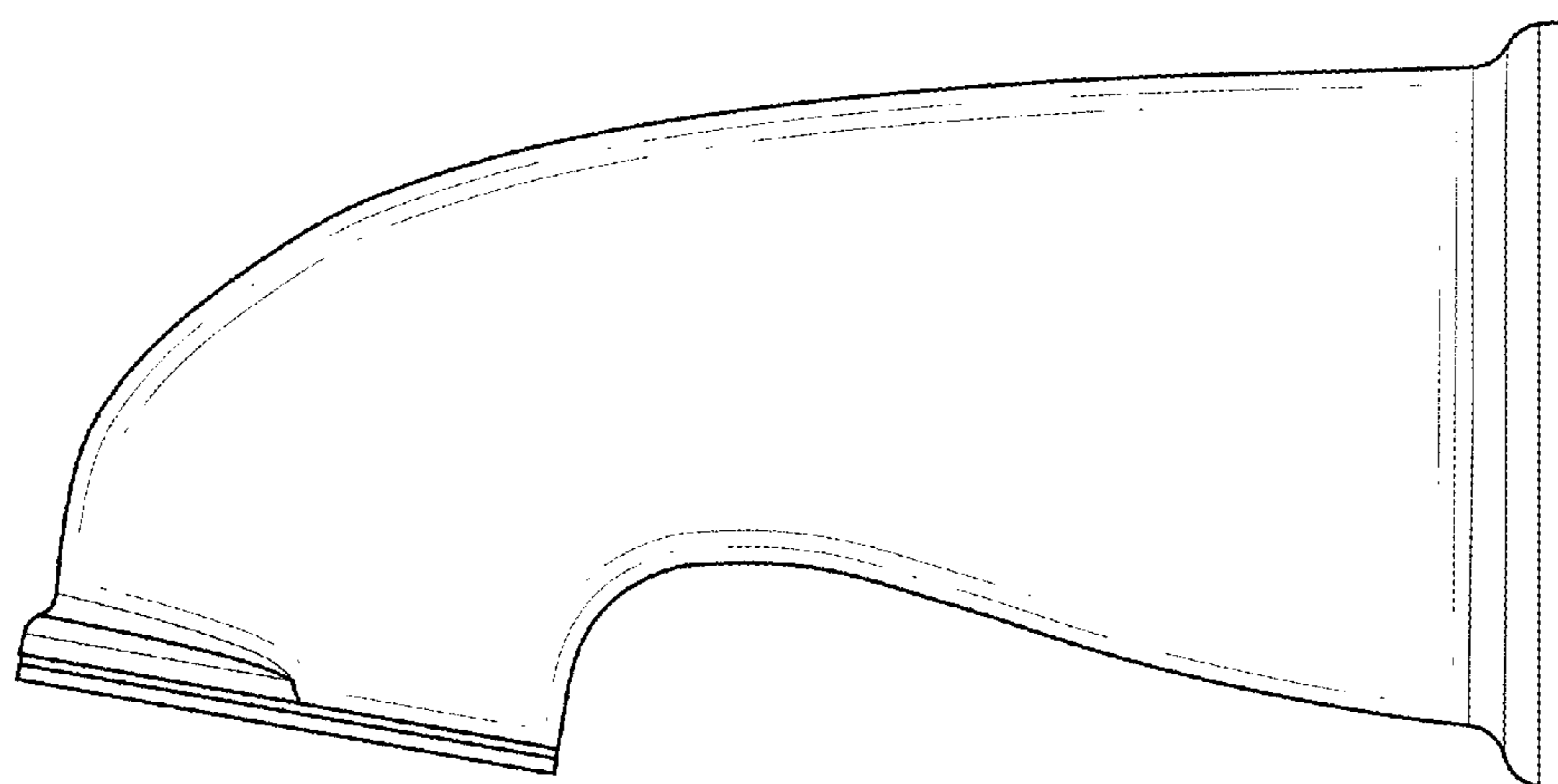

FIG.5

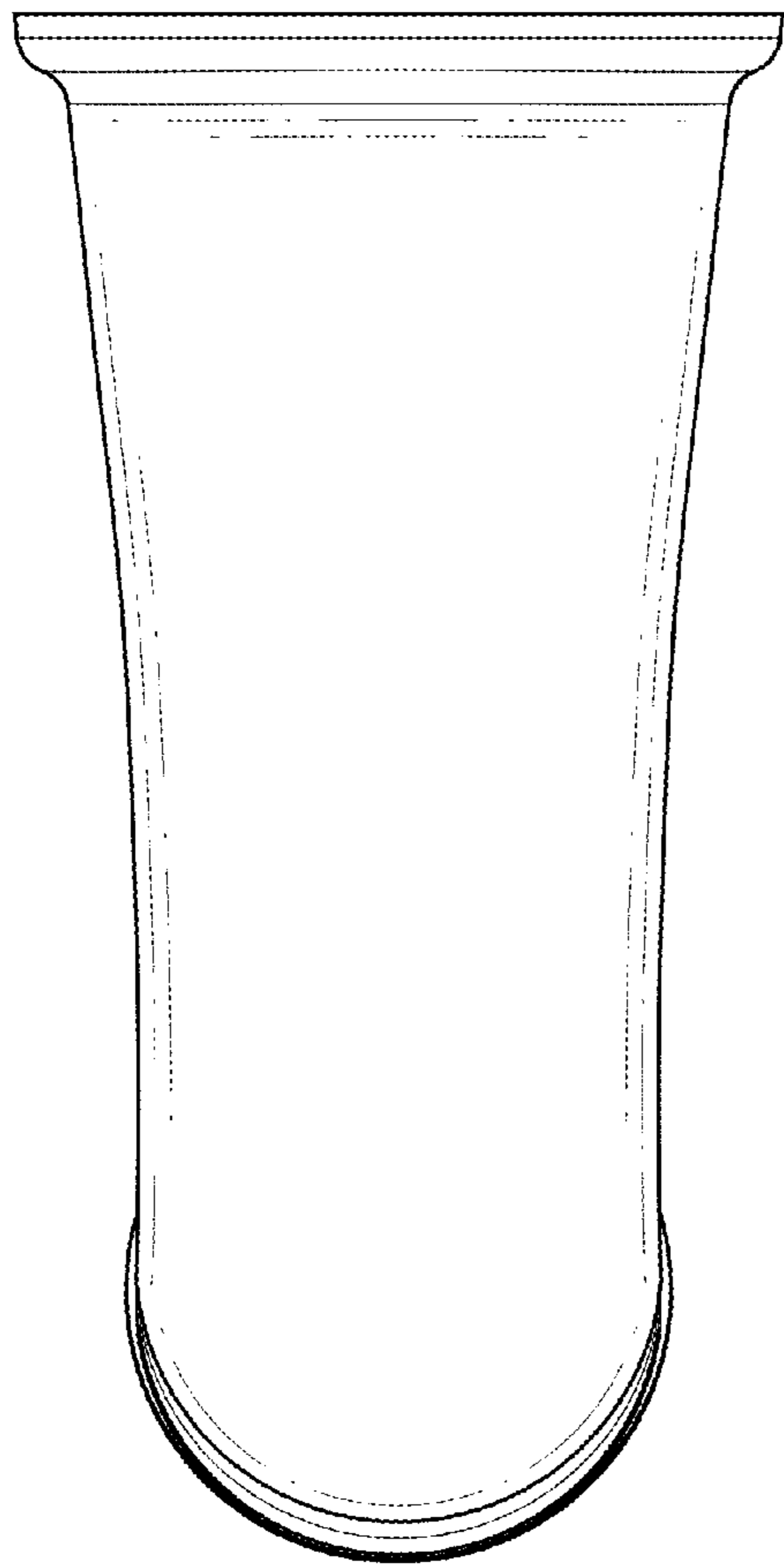

FIG. 6

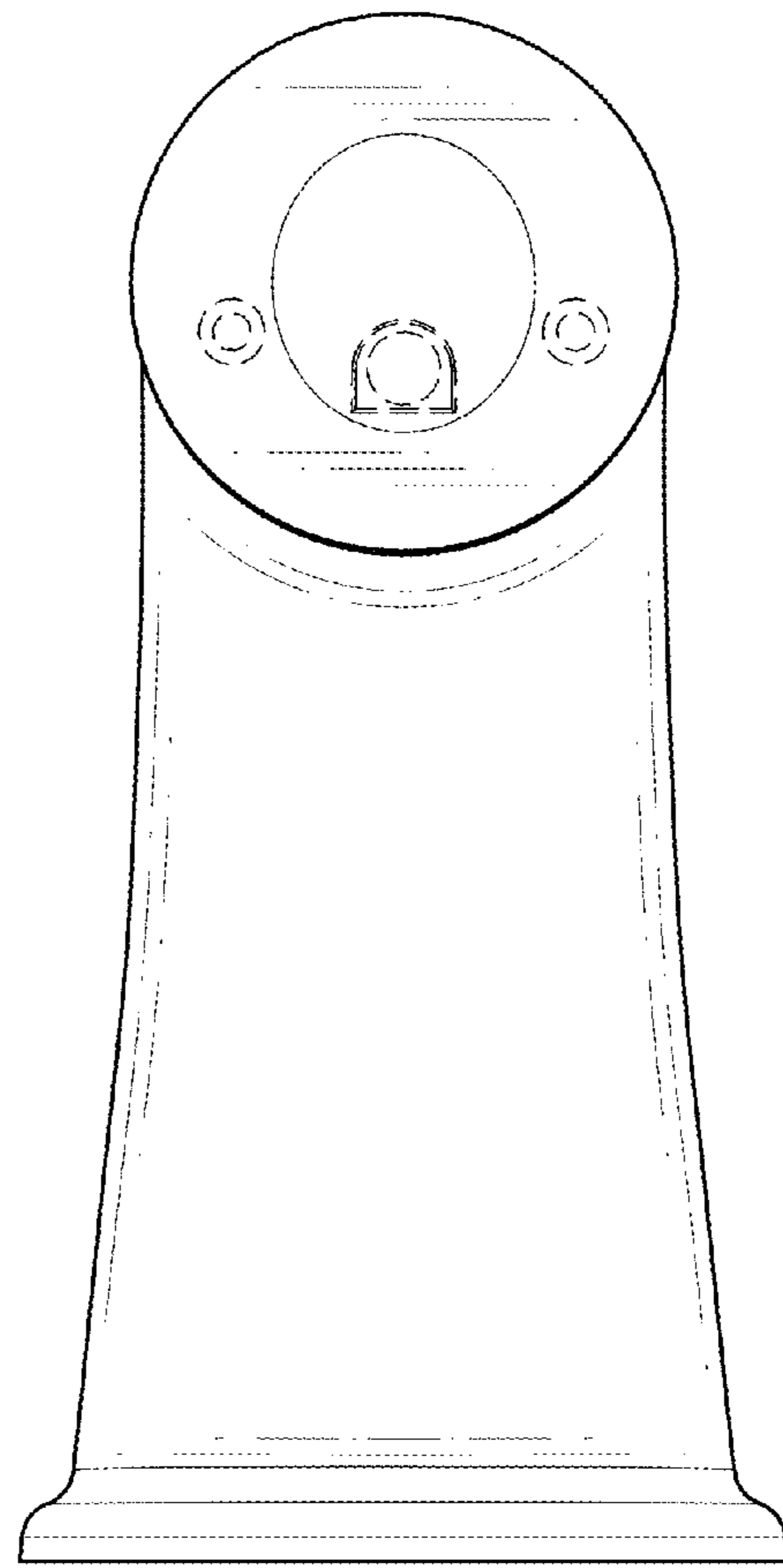

FIG. 7

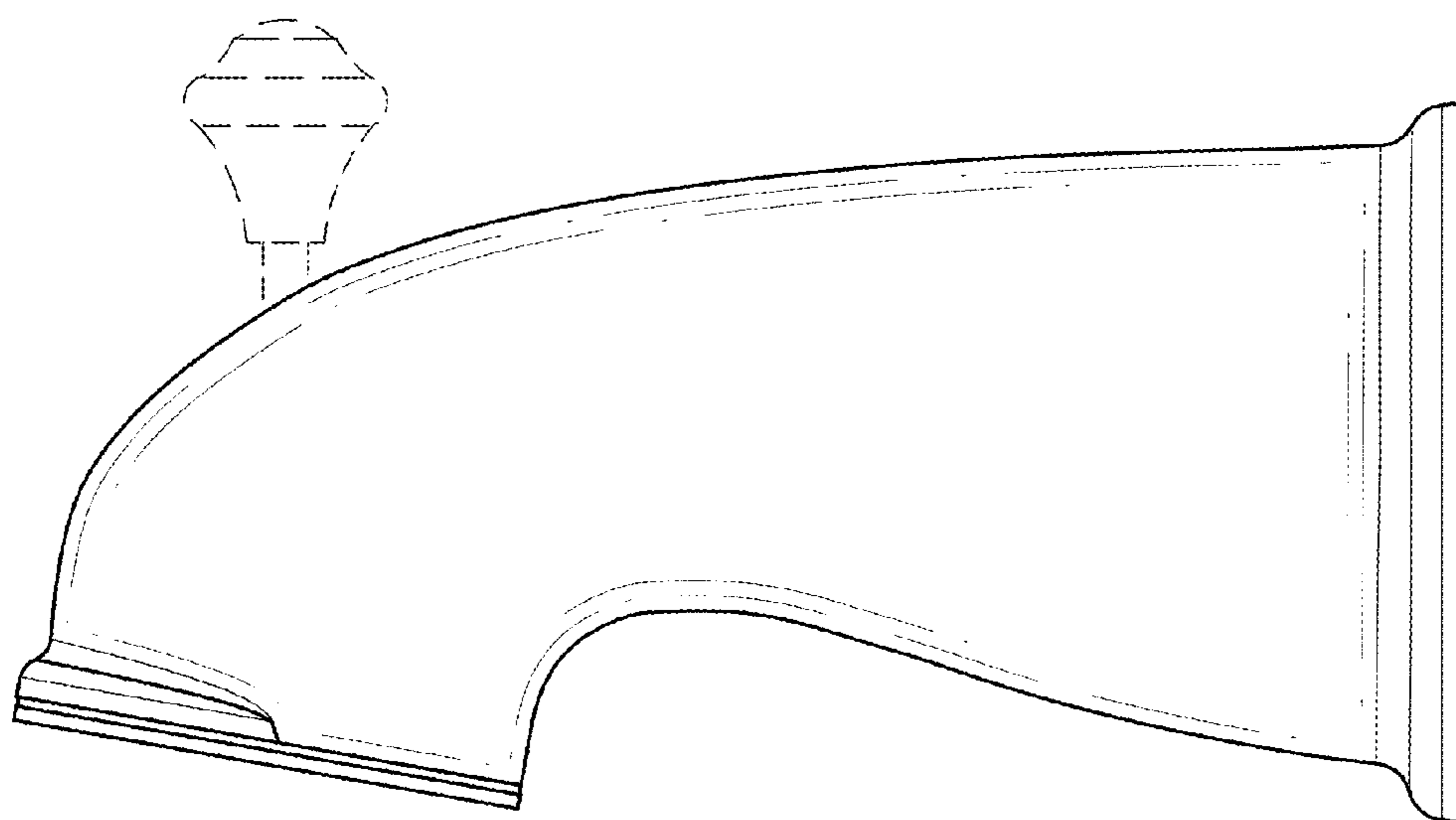

FIG.8