



US00D726269S

(12) **United States Design Patent**
Murphy, Jr.

(10) **Patent No.:** **US D726,269 S**
(45) **Date of Patent:** **** Apr. 7, 2015**

(54) **RACKET HANDLE**

(71) Applicant: **H. Stetser Murphy, Jr.**, Marietta, GA
(US)

(72) Inventor: **H. Stetser Murphy, Jr.**, Marietta, GA
(US)

(**) Term: **14 Years**

(21) Appl. No.: **29/482,719**

(22) Filed: **Feb. 21, 2014**

(51) **LOC (10) Cl.** **21-02**

(52) **U.S. Cl.**
USPC **D21/756**

(58) **Field of Classification Search**
USPC D21/729-732, 756; 473/524-557
See application file for complete search history.

(56) **References Cited**

U.S. PATENT DOCUMENTS

1,638,454 A	8/1927	Papin	
2,166,044 A	7/1939	Lewthwaite	
D247,189 S	2/1978	Charpentier	
D250,905 S *	1/1979	Sawyer	D21/729
4,174,109 A	11/1979	Gaiser	
D258,072 S *	1/1981	Yoneyama	D21/730
D273,507 S *	4/1984	Yoneyama	D21/730
4,478,416 A *	10/1984	Gibello	473/526
4,717,152 A *	1/1988	Kessler	473/551
D305,922 S *	2/1990	Mercado	D21/730
D306,054 S *	2/1990	Chen	D21/730
D307,930 S	5/1990	Sokol et al.	
D315,585 S *	3/1991	Kuebler	D21/730
5,294,117 A	3/1994	Huang	
5,324,030 A *	6/1994	Tsou	473/521
D370,042 S *	5/1996	Blonski	D21/756
D370,043 S *	5/1996	Blonski	D21/756
D370,244 S *	5/1996	Blonski	D21/756
D370,954 S *	6/1996	Blonski	D21/756
D378,389 S	3/1997	Manu	
D380,244 S *	6/1997	Naumoff	D21/756
D394,094 S *	5/1998	Davis et al.	D21/729

(Continued)

Primary Examiner — Mitchell Siegel

(74) *Attorney, Agent, or Firm* — McGurk Intellectual Property Advisors

(57) **CLAIM**

I claim the ornamental design for a racket handle, as shown and described.

DESCRIPTION

FIG. 1 is a perspective view of a design of a racket handle illustrating the claimed design, wherein the racket handle is attached to a tennis racket;

FIG. 2 is a front view of the design of the racket handle shown in FIG. 1;

FIG. 3 is a back view of the design of the racket handle shown in FIG. 1;

FIG. 4 is a left side view of the design of the racket handle shown in FIG. 1;

FIG. 5 is a right side view of the design of the racket handle shown in FIG. 1;

FIG. 6 is a top view of the design of the racket handle shown in FIG. 1;

FIG. 7 is a bottom view of the design of the racket handle shown in FIG. 1.

FIG. 8 is an enlarged perspective view of the design of the racket handle of FIG. 1 excluding the head and neck portions of the tennis racket shown in FIG. 1.

FIG. 9 is an enlarged front view of the design of the racket handle shown in FIG. 8.

FIG. 10 is an enlarged back view of the design of the racket handle shown in FIG. 8.

FIG. 11 is an enlarged left side view of the design of the racket handle shown in FIG. 8.

FIG. 12 is an enlarged right side view of the design of the racket handle shown in FIG. 8.

FIG. 13 is a cross-sectional view taken along line A-A of FIG. 9 of the design of the racket handle shown in FIG. 8; and,

FIG. 14 is a bottom view of the design of the racket handle shown in FIG. 8.

The broken lines in the drawings are for illustrative purposes only and form no part of the claimed design.

1 Claim, 9 Drawing Sheets

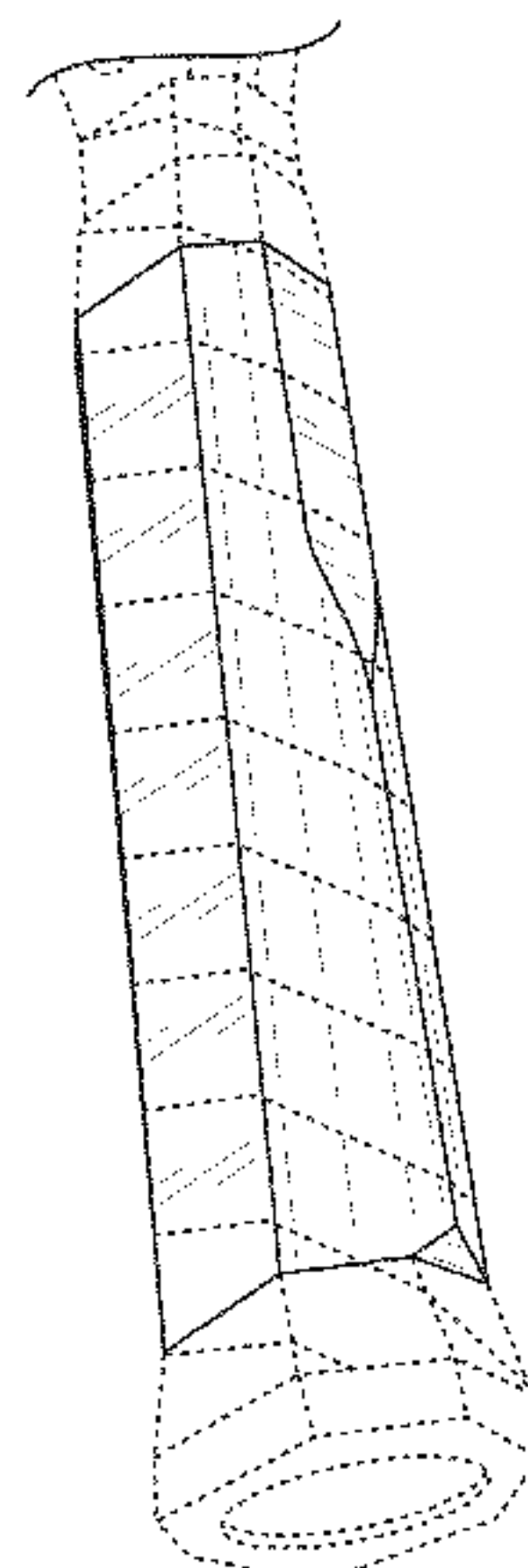

(56)

References Cited

U.S. PATENT DOCUMENTS

D477,645 S * 7/2003 Vito D21/756
D484,206 S 12/2003 Udwin et al.

D484,556 S 12/2003 Udwin et al.
D488,844 S 4/2004 Szelenyi
8,298,101 B2 10/2012 Babolat
D703,779 S * 4/2014 Budacsek D21/756

* cited by examiner

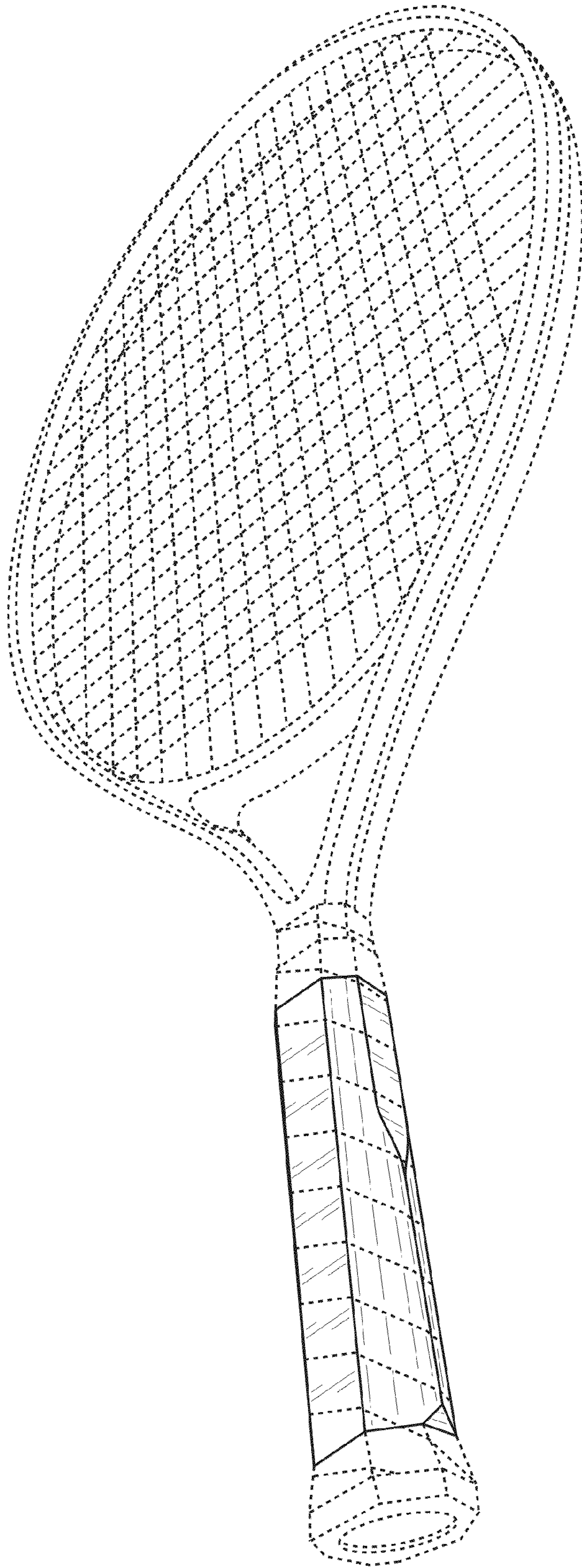

FIG. 1

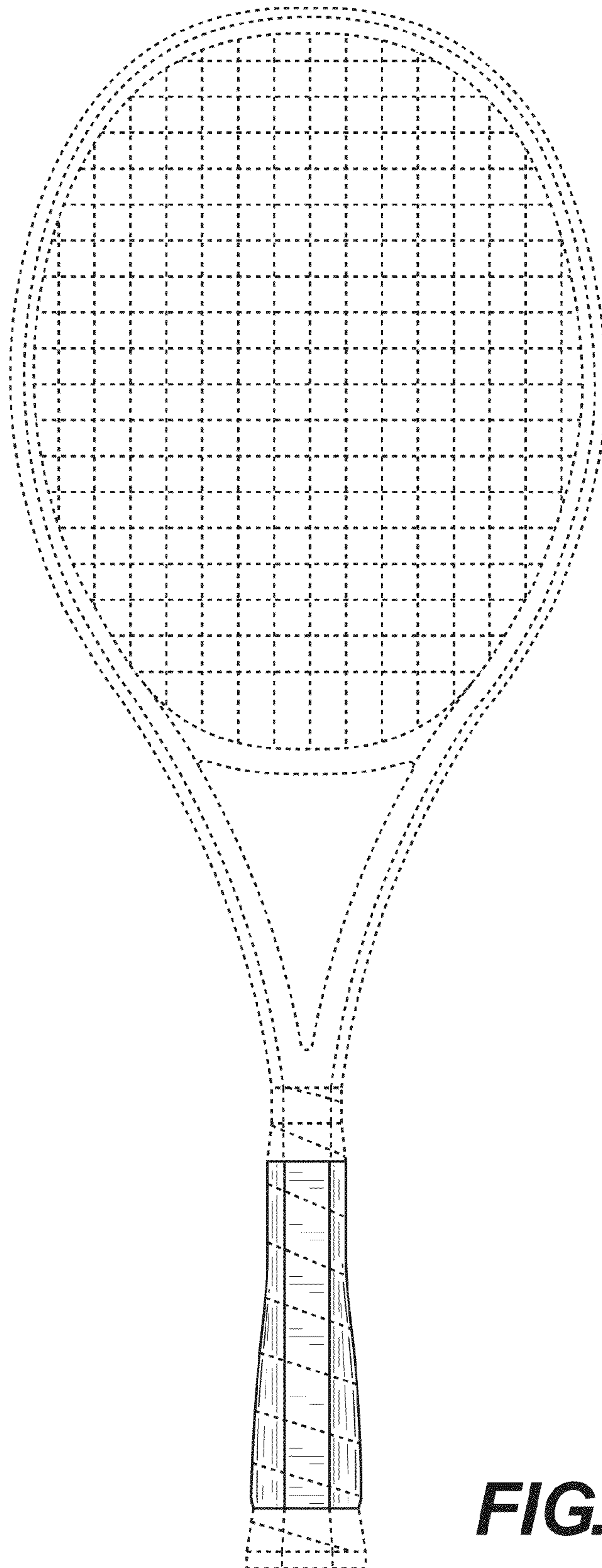

FIG. 2

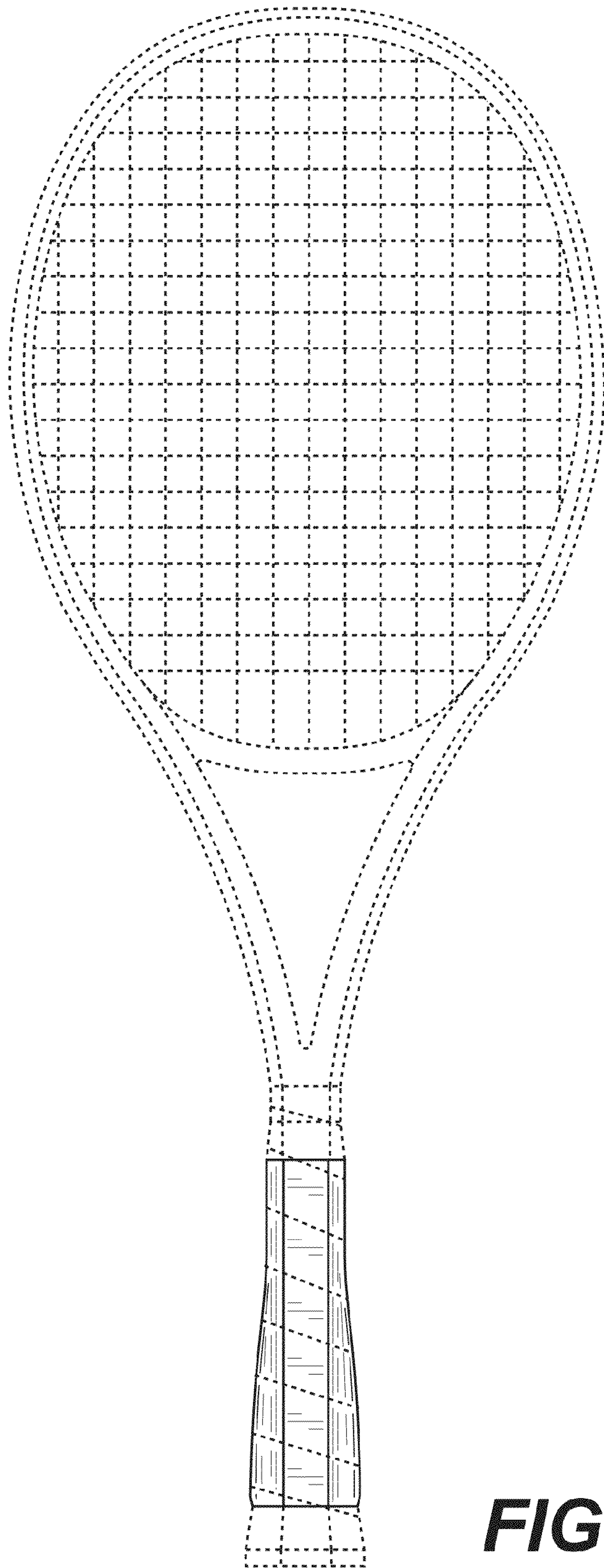

FIG. 3

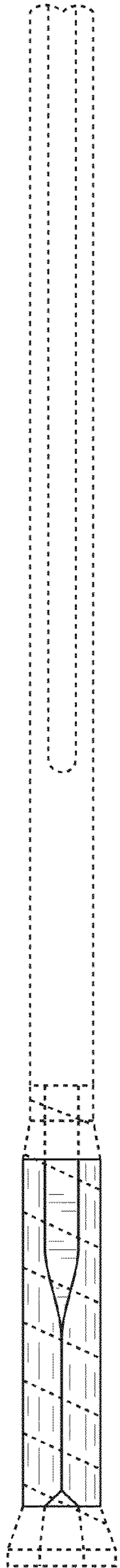

FIG. 4

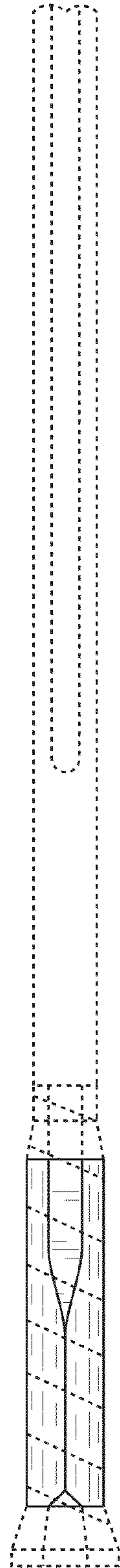

FIG. 5

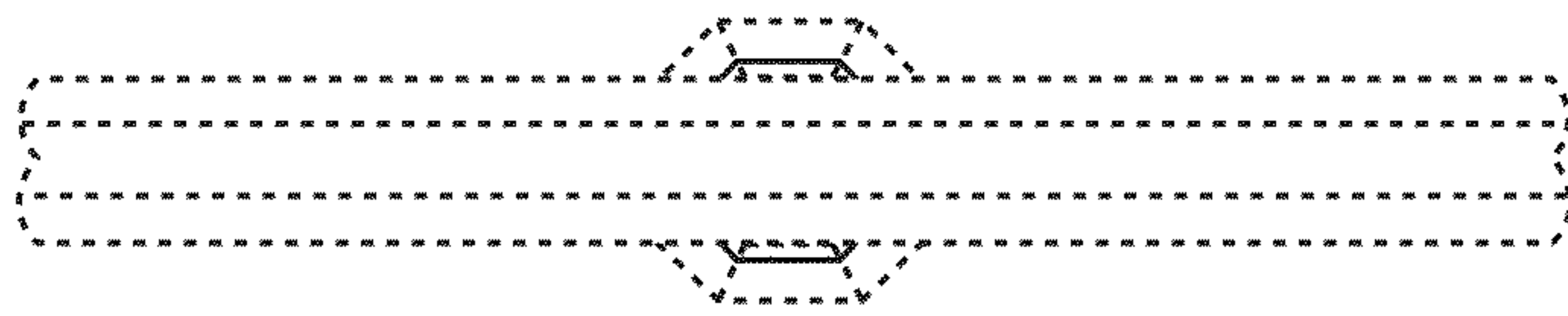

FIG. 6

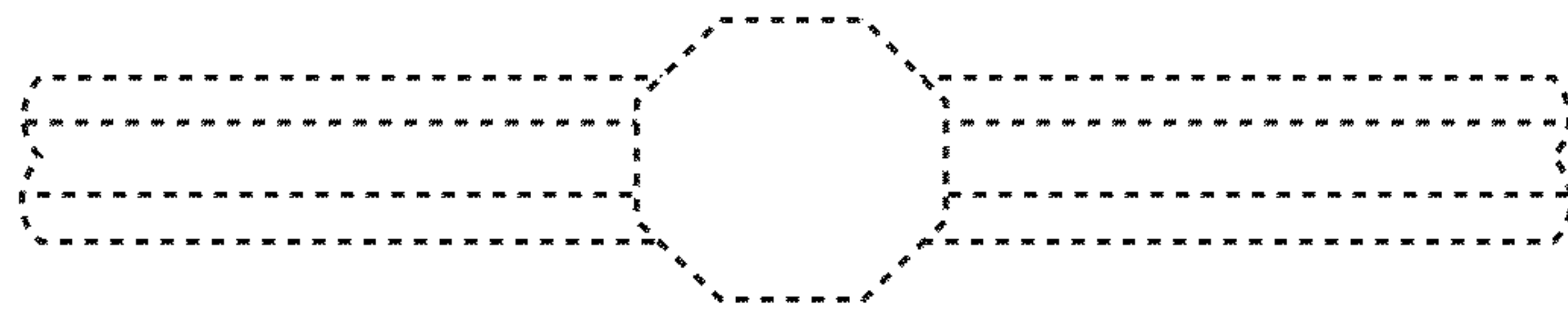

FIG. 7

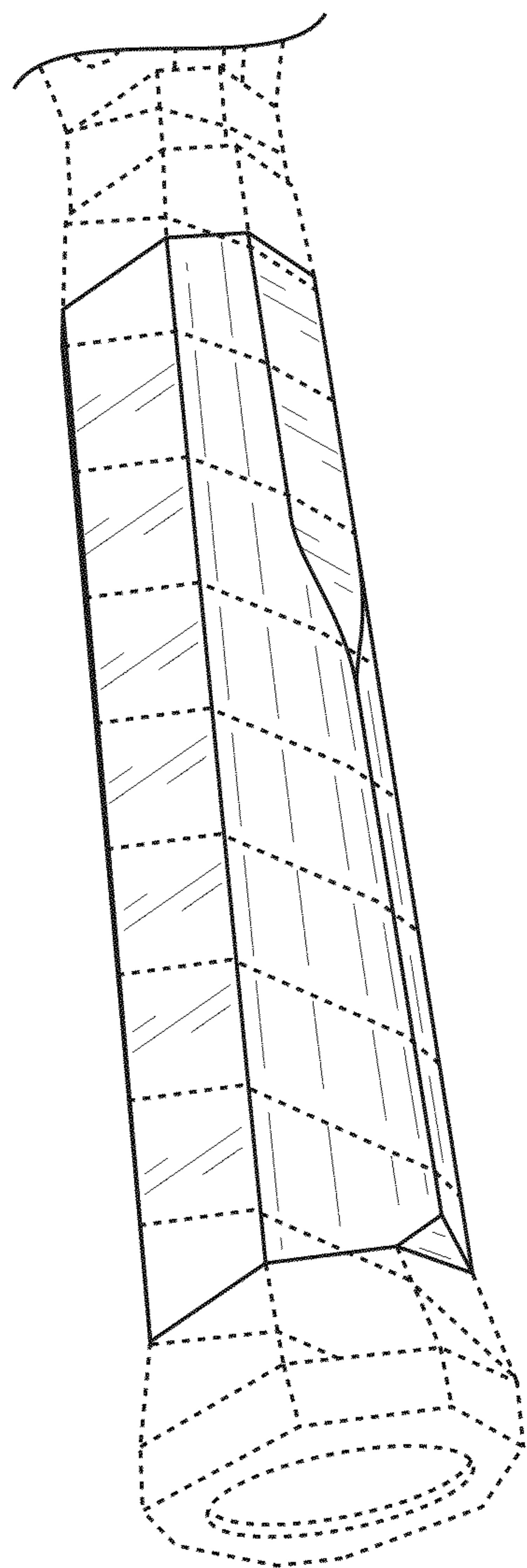

FIG. 8

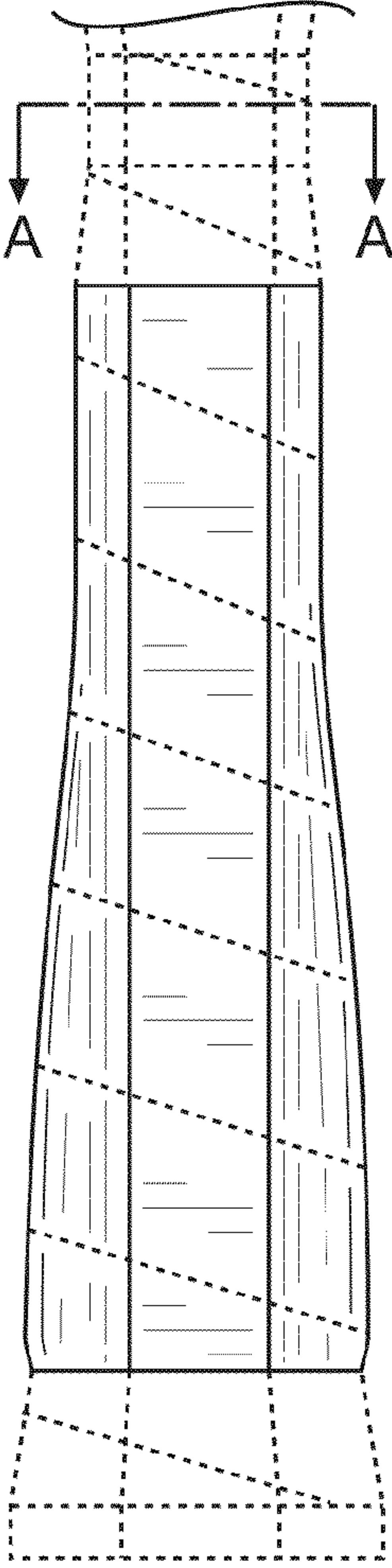

FIG. 9

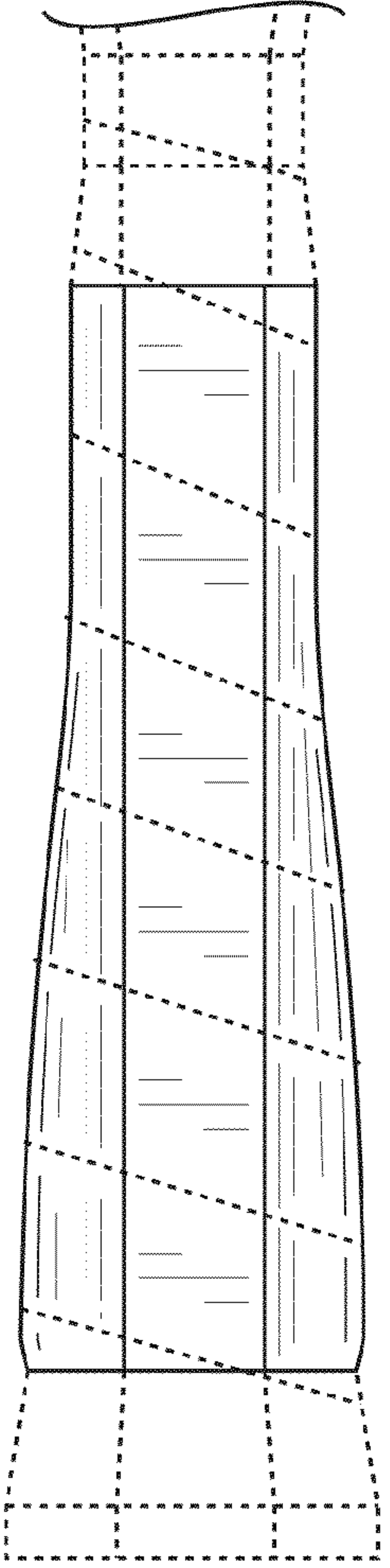

FIG. 10

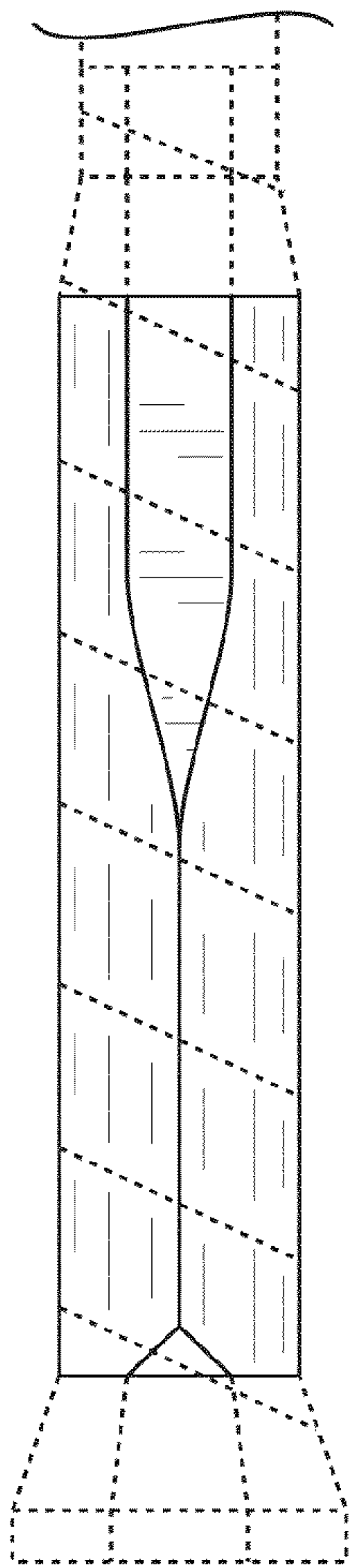

FIG. 11

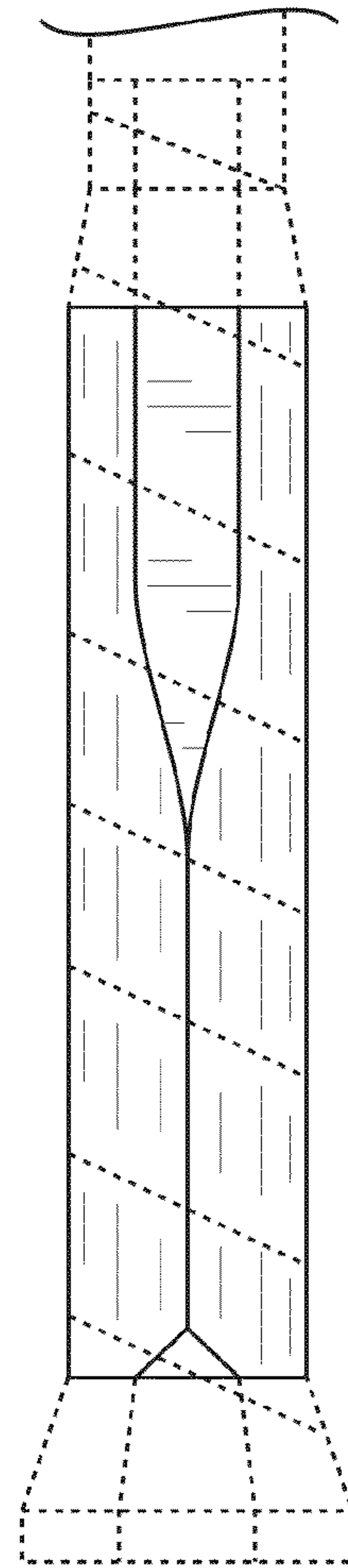

FIG. 12

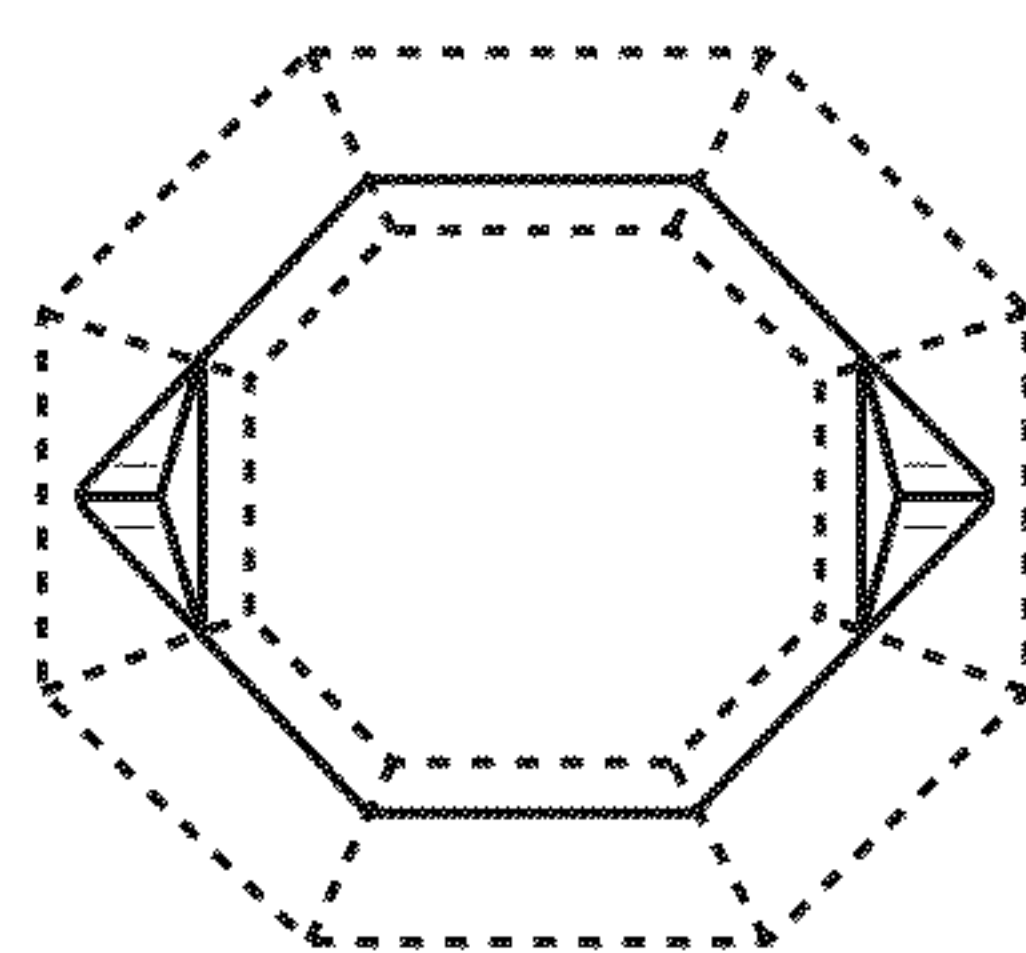

FIG. 13

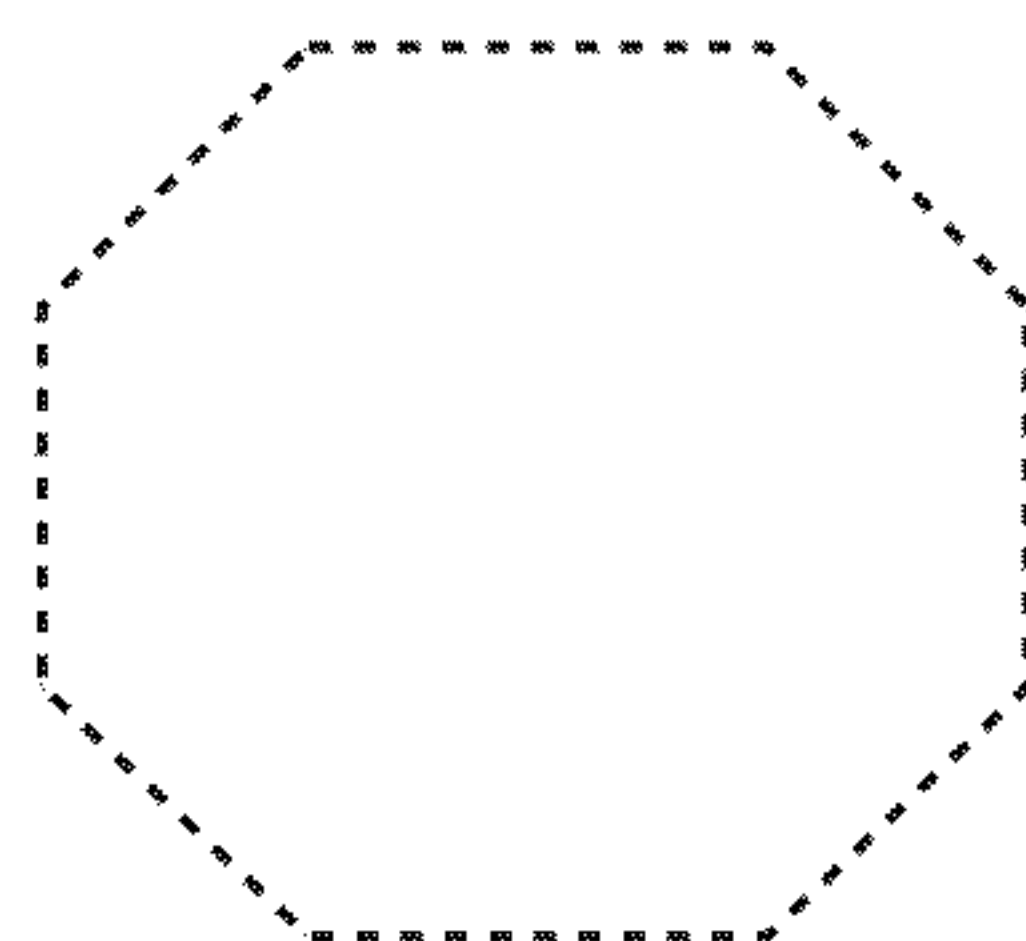

FIG. 14