

US00D725968S

(12) **United States Design Patent**  
**George**

(10) **Patent No.:** **US D725,968 S**  
(45) **Date of Patent:** **\*\* Apr. 7, 2015**

- (54) **BEVERAGE CONTAINER**
- (71) Applicant: **Pacific Market International, LLC**,  
Seattle, WA (US)
- (72) Inventor: **Sarah Danger George**, Vashon, WA  
(US)
- (73) Assignee: **Pacific Market International, LLC**,  
Seattle, WA (US)
- (\*\*) Term: **14 Years**
- (21) Appl. No.: **29/464,954**
- (22) Filed: **Aug. 22, 2013**
- (51) **LOC (10) Cl.** ..... **07-01**
- (52) **U.S. Cl.**  
USPC ..... **D7/511**
- (58) **Field of Classification Search**  
USPC ..... D3/264; D7/300, 302, 305, 317, 319,  
D7/321, 322, 500, 507, 509, 510, 511, 543,  
D7/549, 560, 588, 601, 602, 605, 619.1,  
D7/622, 705; D9/434, 435, 436, 440, 443,  
D9/445, 500, 503, 504, 519, 530, 533, 689,  
D9/737, 738; 206/5, 5.1  
See application file for complete search history.

- D652,682 S \* 1/2012 Eyal ..... D7/510
- D655,134 S \* 3/2012 Gilbert ..... D7/510
- D695,069 S \* 12/2013 Lane ..... D7/510
- D695,138 S \* 12/2013 Ball ..... D9/772
- D701,428 S \* 3/2014 Lapsker ..... D7/532
- D703,052 S \* 4/2014 Park ..... D9/503
- D709,734 S \* 7/2014 Kotani ..... D7/608

**FOREIGN PATENT DOCUMENTS**

CN 300780684 \* 5/2008

\* cited by examiner

*Primary Examiner* — Susan Bennett Hattan

*Assistant Examiner* — Leanne Was

(74) *Attorney, Agent, or Firm* — Davis Wright Tremaine  
LLP; George C. Rondeau, Jr.

(57) **CLAIM**

The ornamental design for a beverage container, as shown and described.

**DESCRIPTION**

FIG. 1 is a top left side perspective view of a beverage container showing my new design.  
 FIG. 2 is a front elevational view thereof.  
 FIG. 3 is a left side elevational view thereof.  
 FIG. 4 is a right side elevational view thereof.  
 FIG. 5 is a rear elevational view thereof.  
 FIG. 6 is a top plan view thereof.  
 FIG. 7 is a bottom plan view thereof.  
 FIG. 8 is a top left side perspective view of a second embodiment thereof.  
 FIG. 9 is a front elevational view thereof.  
 FIG. 10 is a left side elevational view thereof.  
 FIG. 11 is a right side elevational view thereof.  
 FIG. 12 is a rear elevational view thereof.  
 FIG. 13 is a top plan view thereof; and,  
 FIG. 14 is a bottom plan view thereof.  
 The broken lines represent portions of the beverage container that form no part of the claim.

**1 Claim, 12 Drawing Sheets**

(56) **References Cited**

**U.S. PATENT DOCUMENTS**

- D347,359 S 5/1994 Robbins
- D379,714 S \* 6/1997 Cerny et al. .... D3/264
- D384,281 S 9/1997 Wong
- D474,651 S \* 5/2003 Ward ..... D7/615
- D547,652 S 7/2007 Kerman et al.
- D554,503 S 11/2007 Kerman et al.
- D554,993 S 11/2007 Kerman et al.
- D599,168 S \* 9/2009 Alviar et al. .... D7/510
- D623,906 S 9/2010 George
- D627,604 S \* 11/2010 Eyal ..... D7/510
- D639,166 S \* 6/2011 Carreno ..... D9/504
- D639,660 S \* 6/2011 Carreno ..... D9/504
- D649,055 S \* 11/2011 Fracasso ..... D9/503

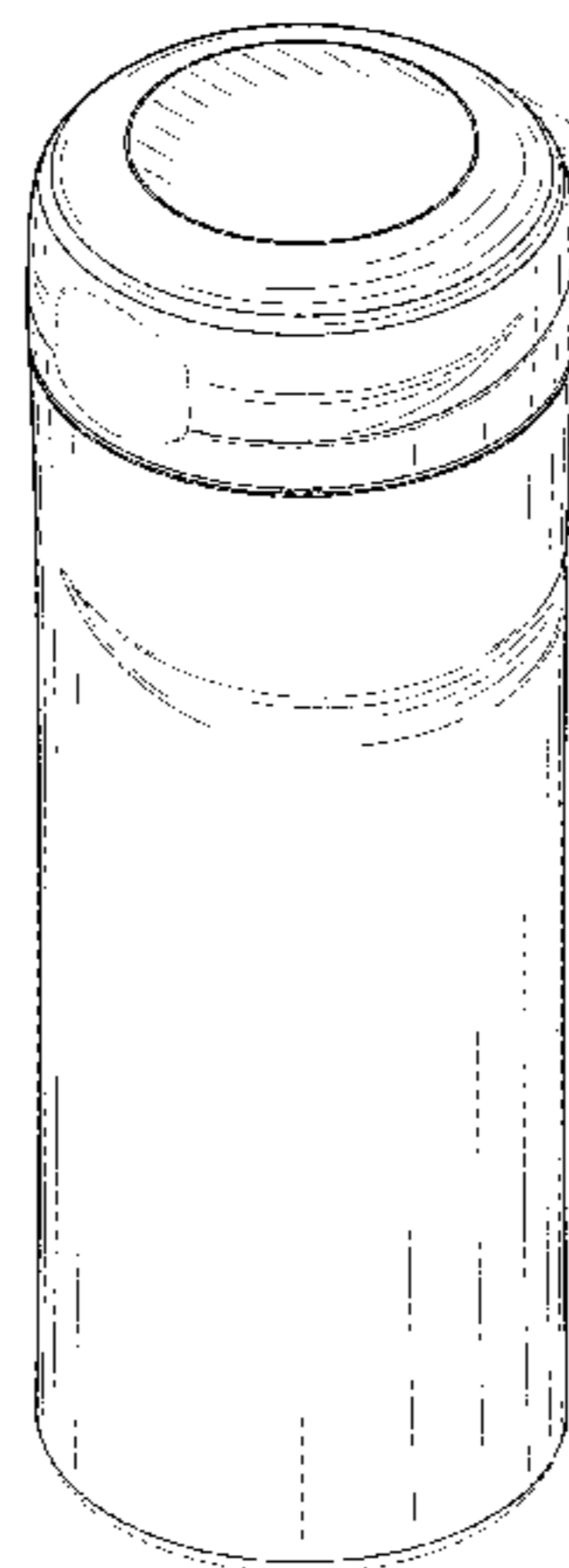
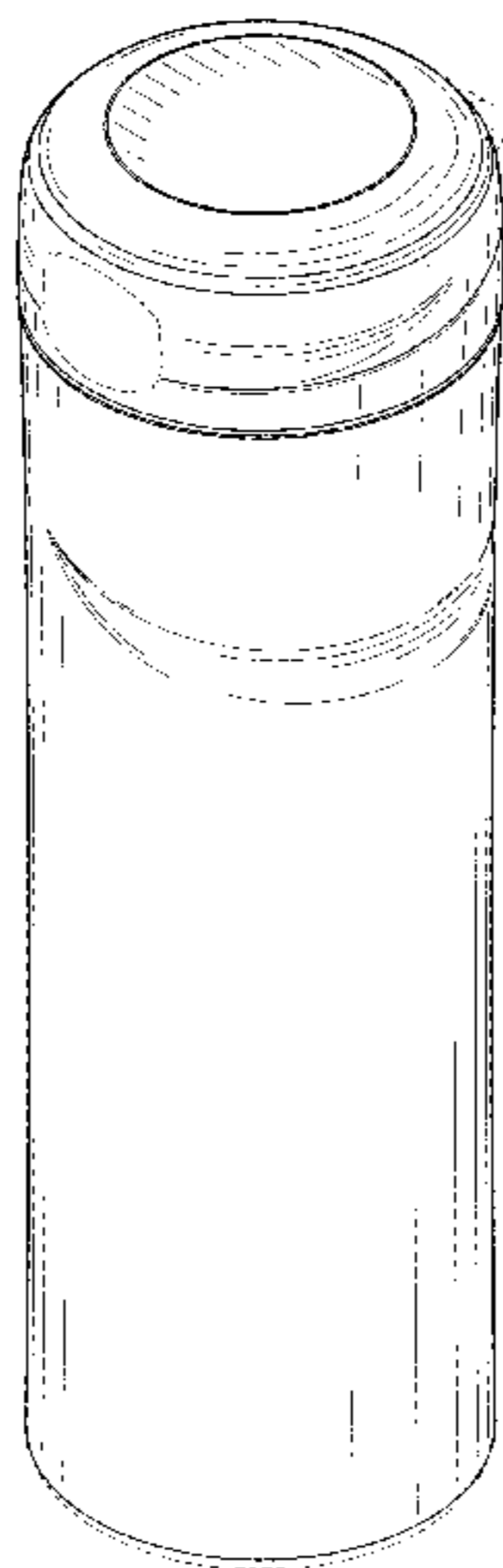

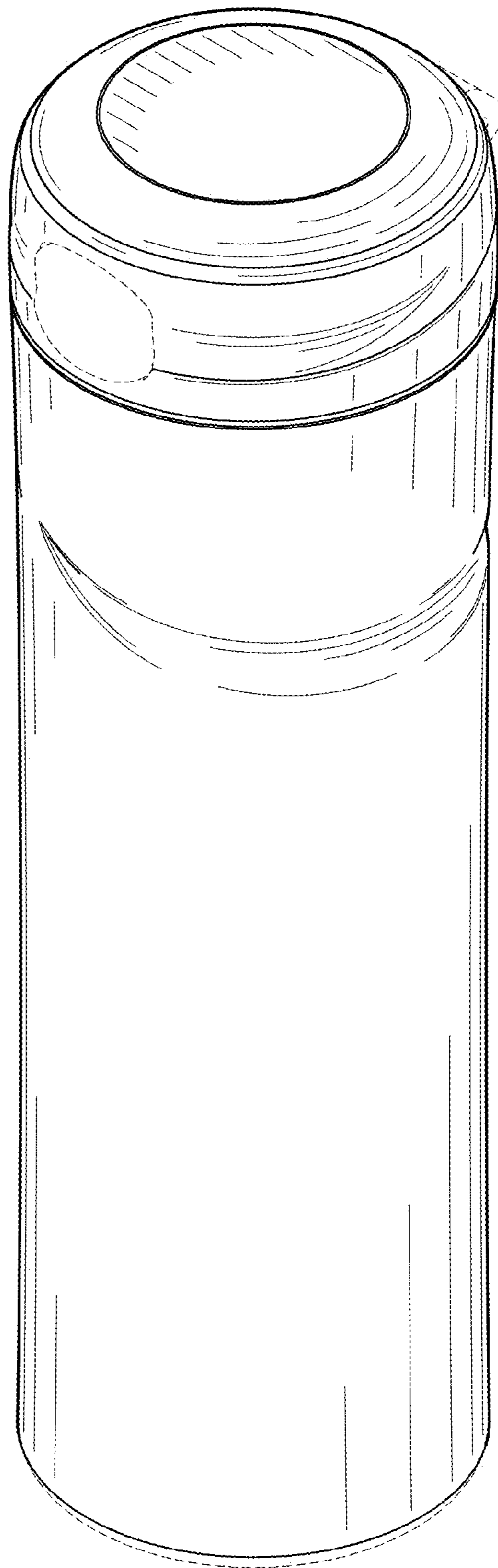

FIG. 1

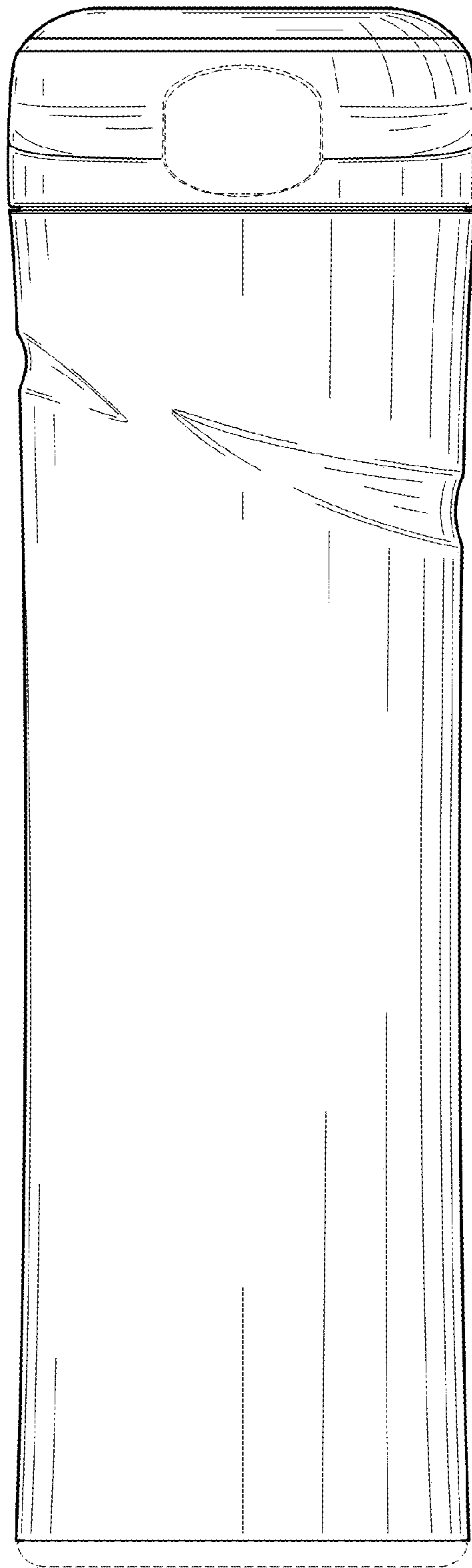

FIG. 2

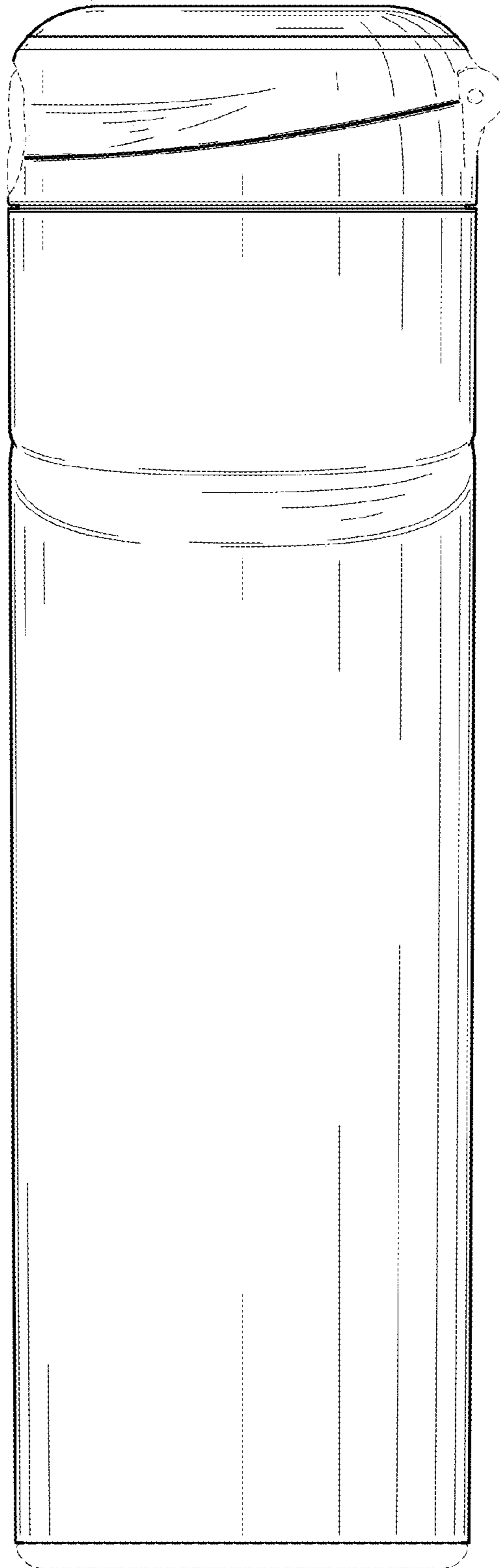

FIG. 3

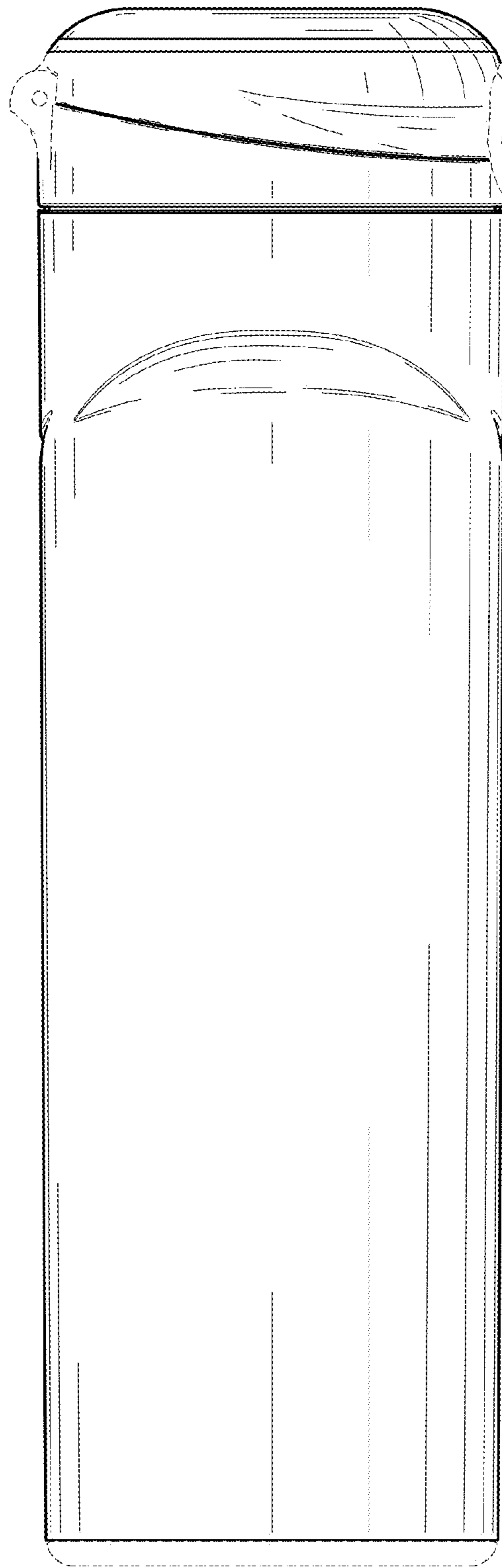

FIG.4

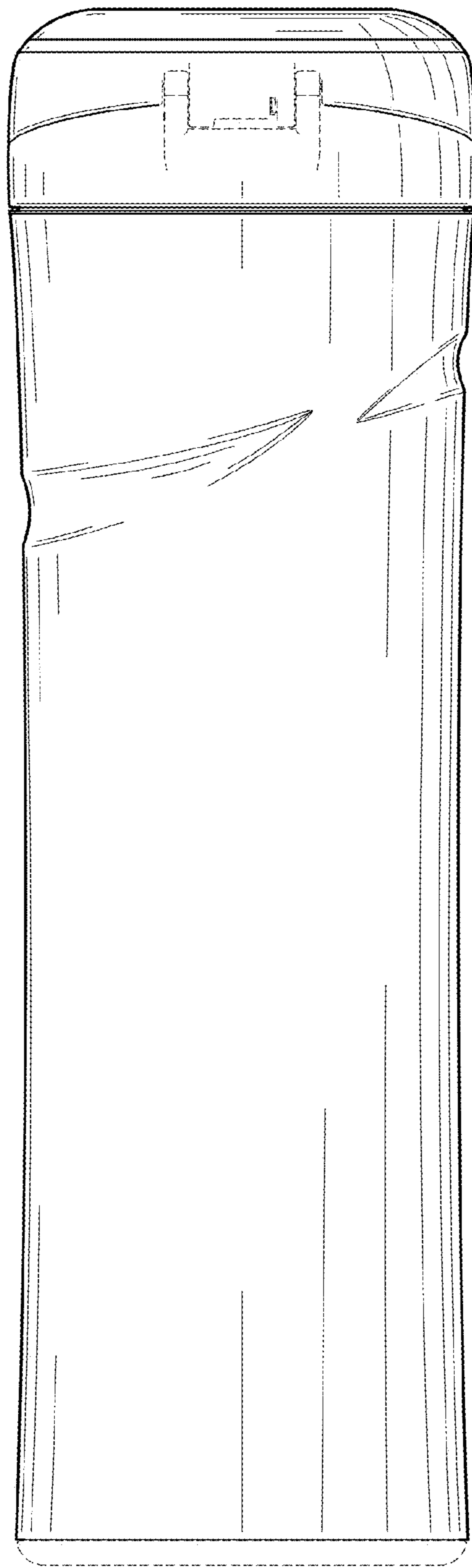

FIG.5

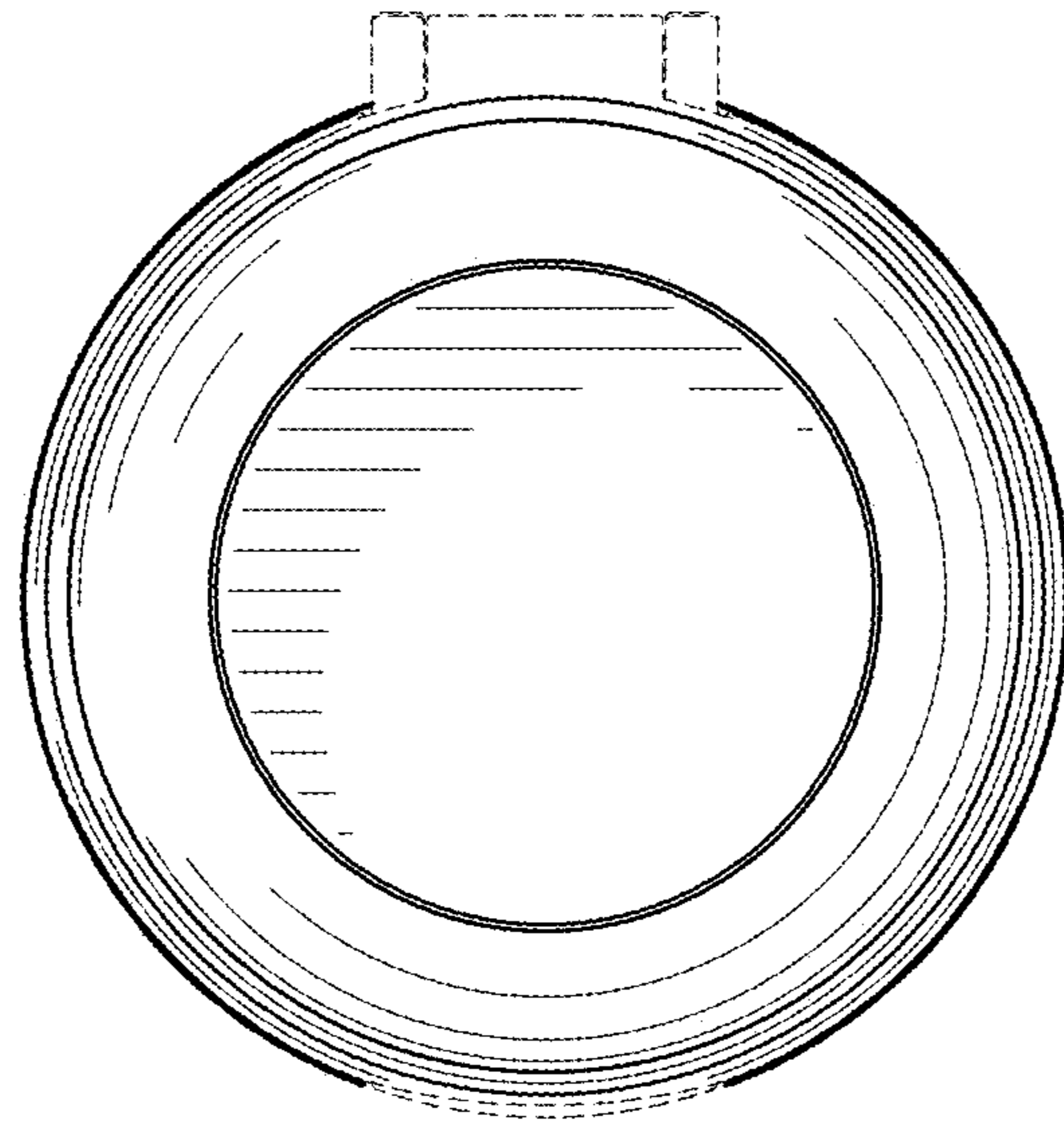

FIG. 6

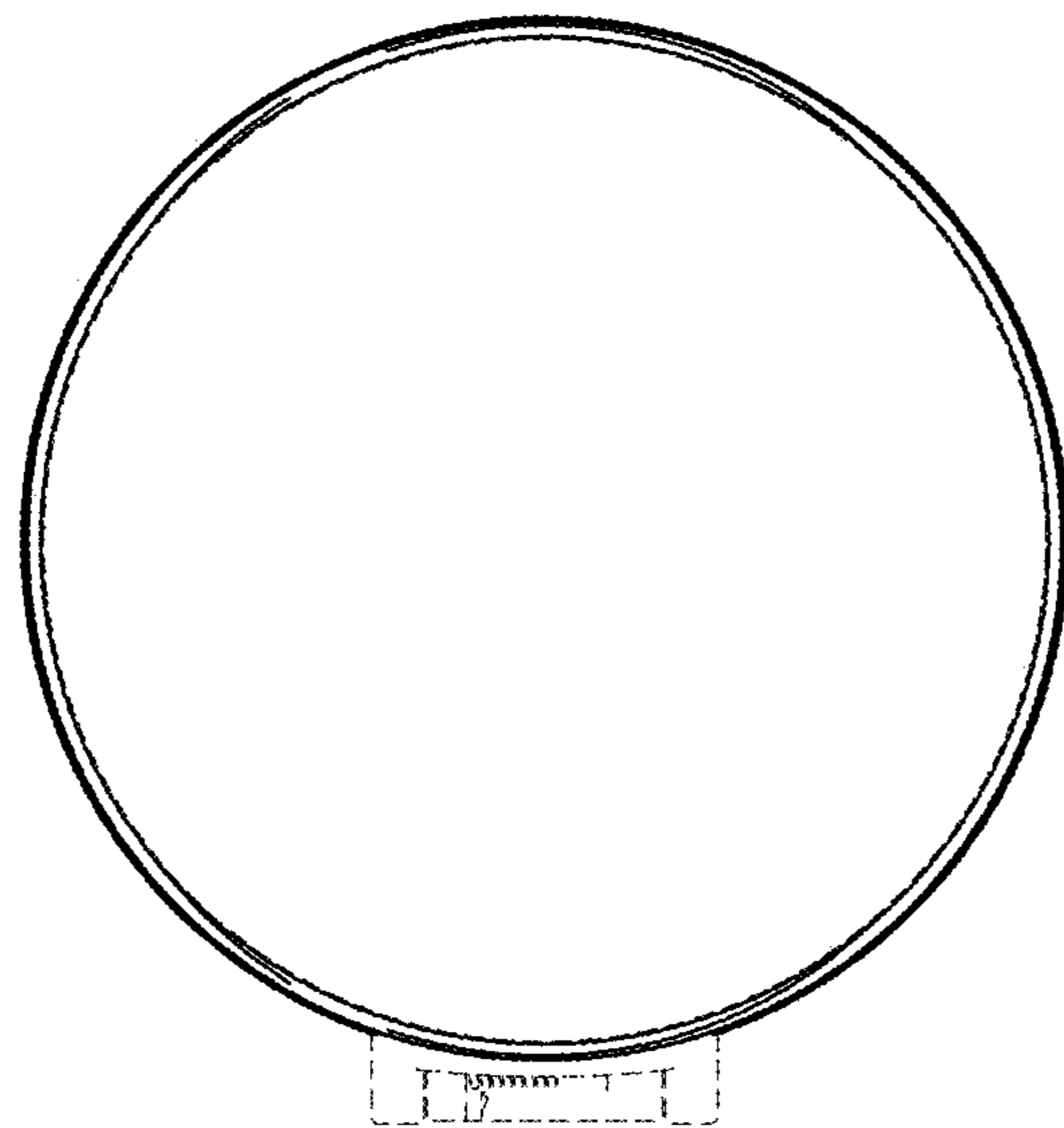

FIG. 7

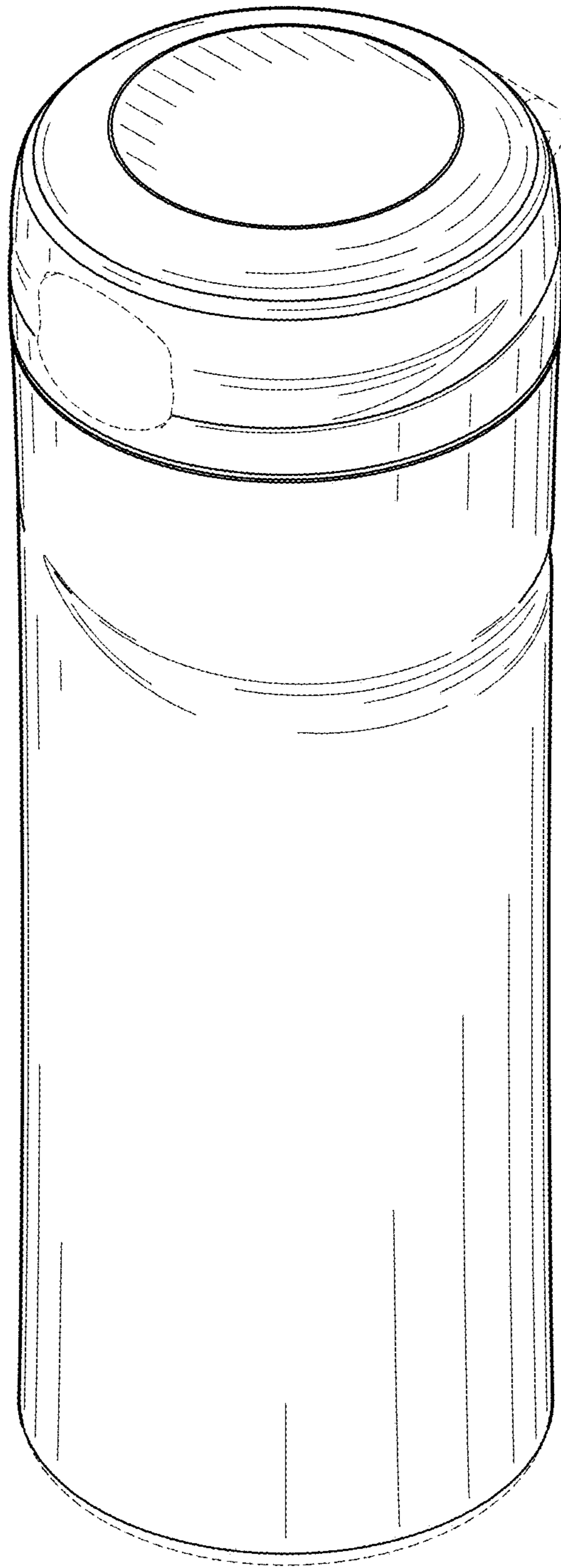

FIG. 8



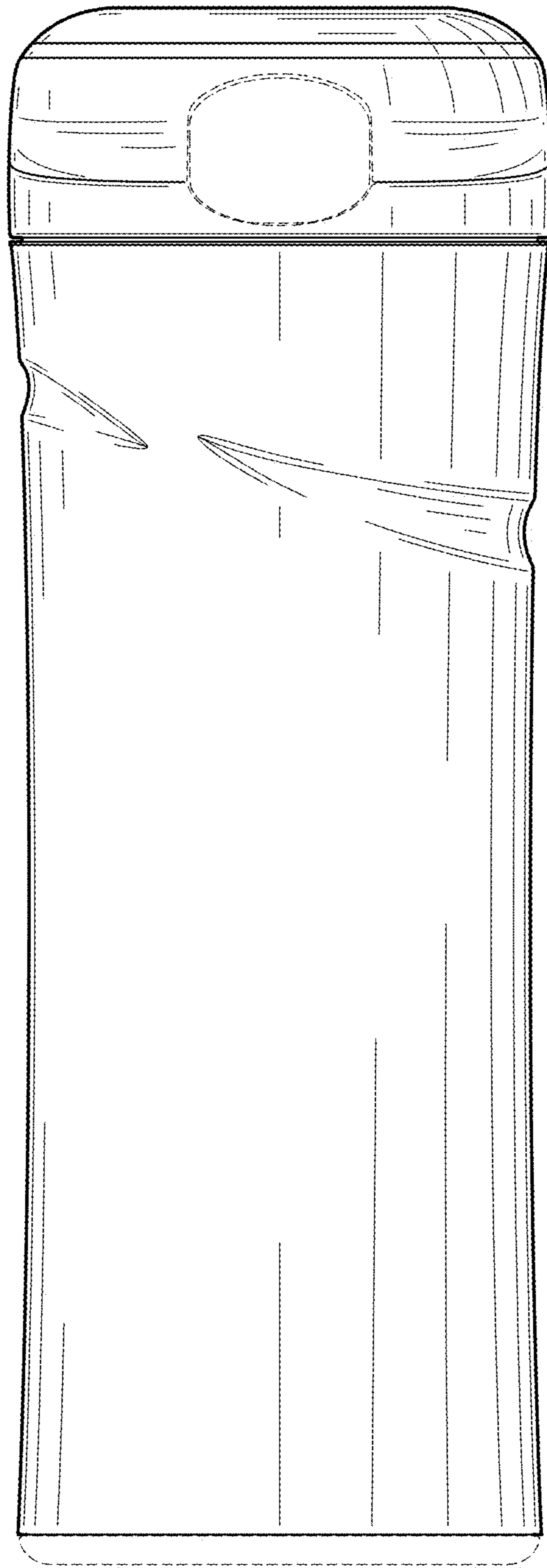

FIG. 9

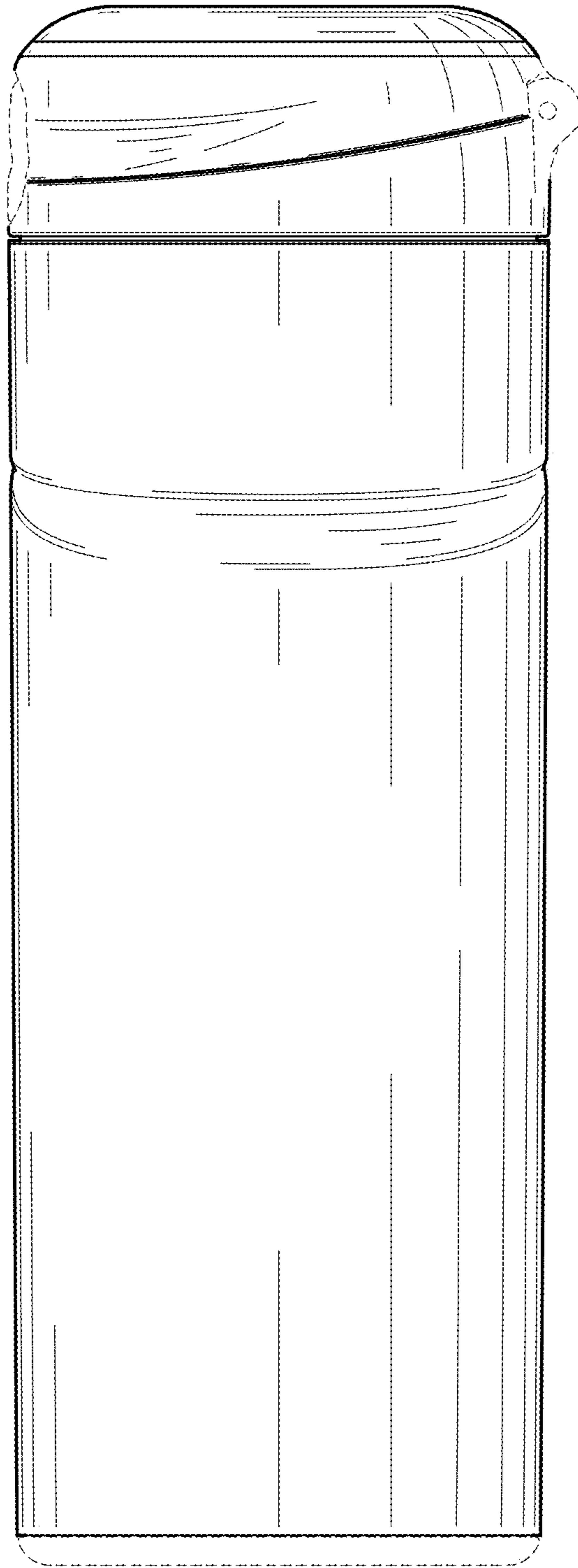

FIG.10

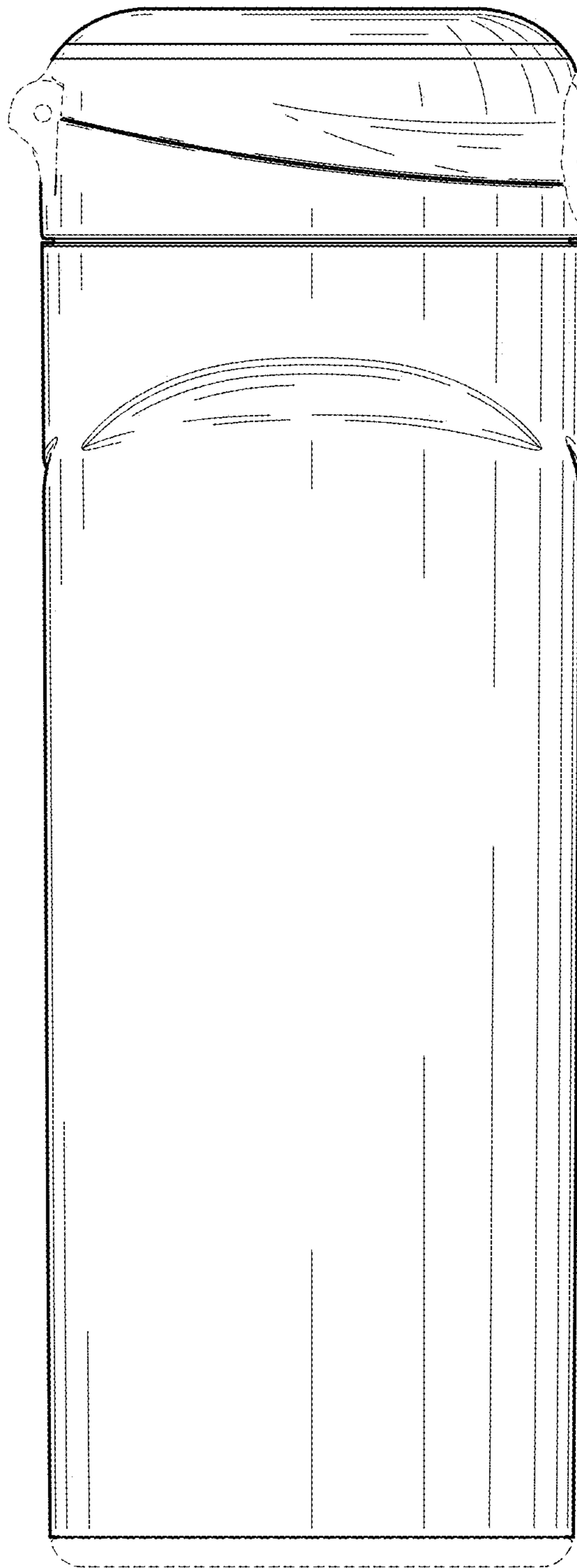

FIG. 11

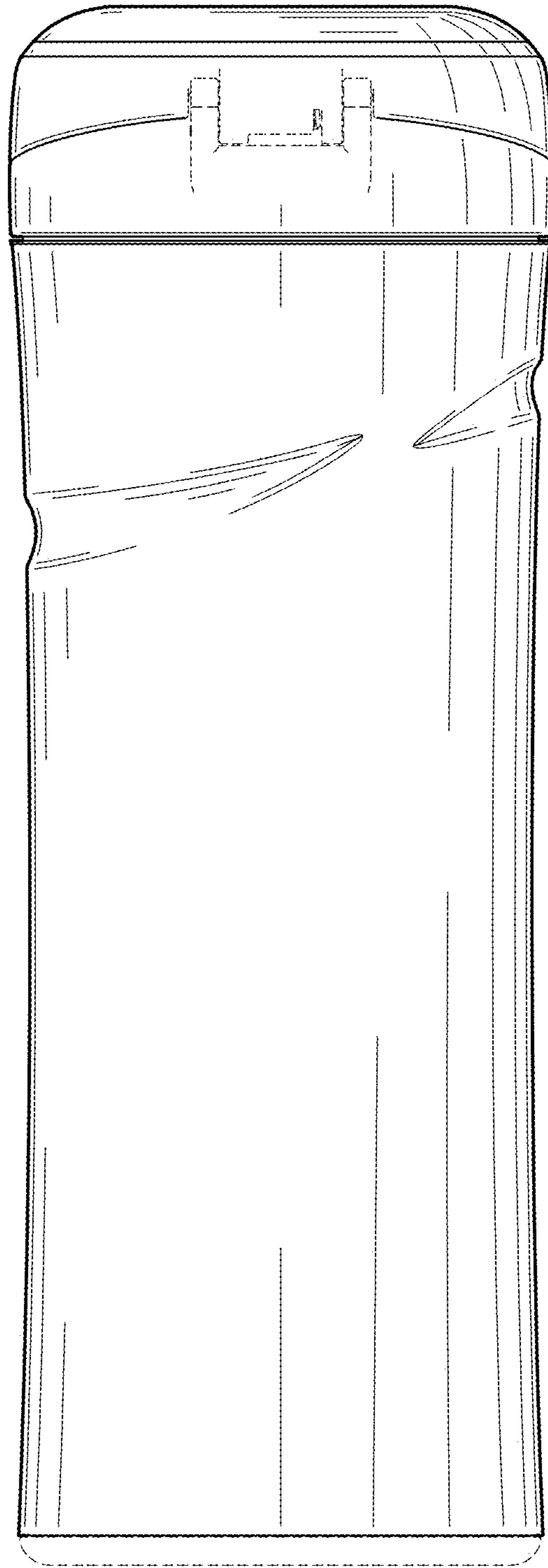

FIG.12

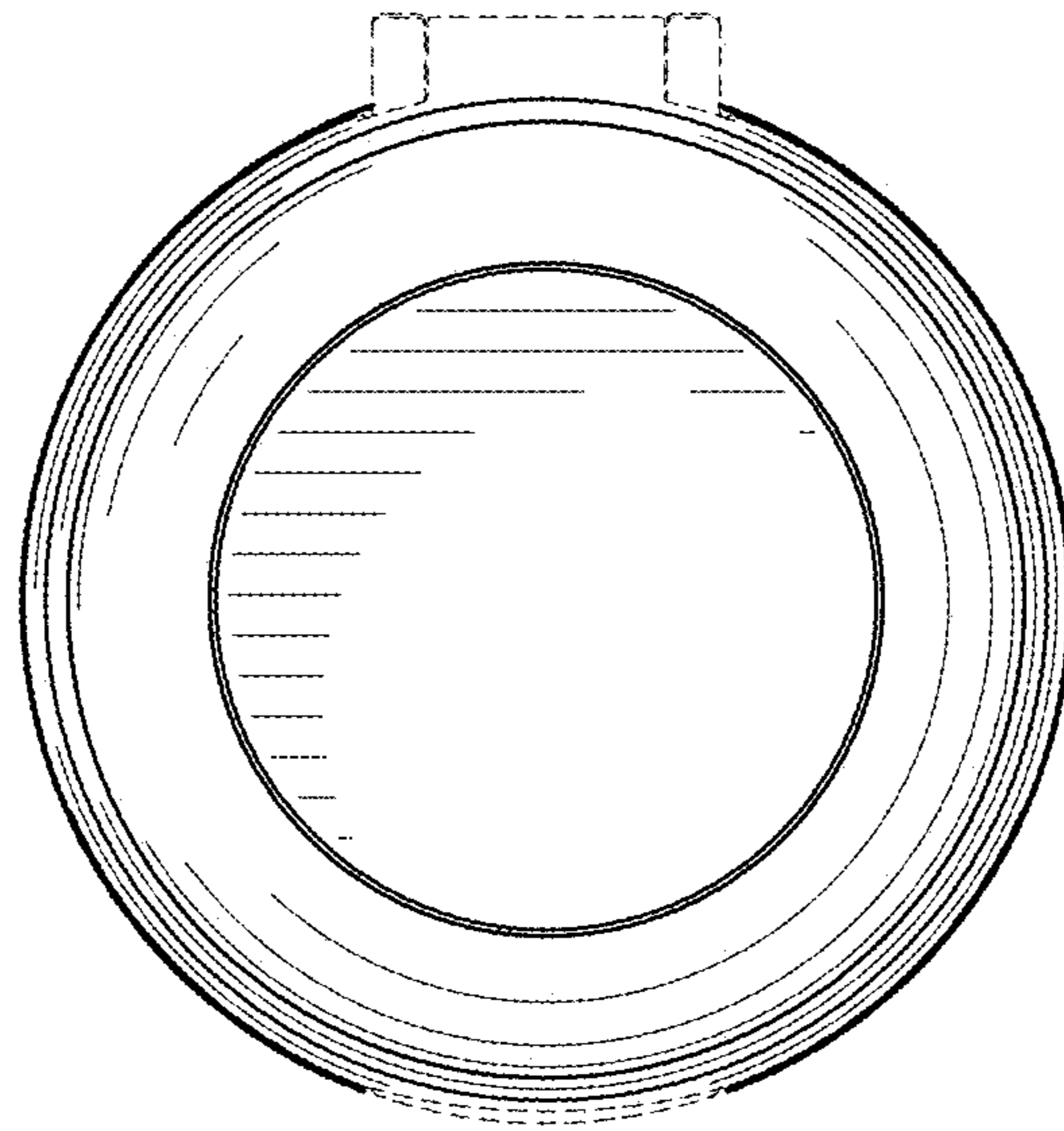

FIG.13

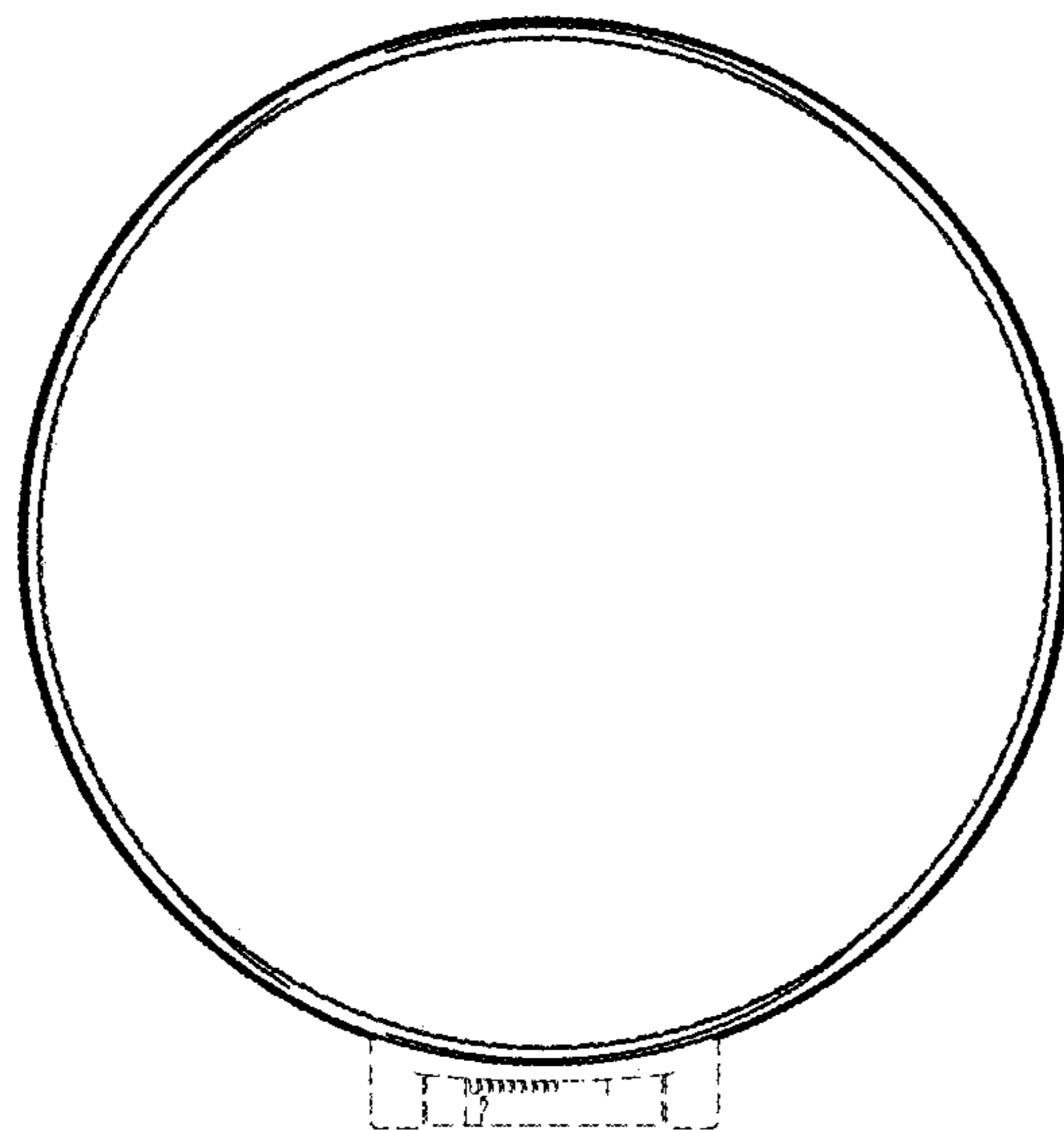

FIG.14