



US00D725965S

(12) **United States Design Patent**  
**Bo**

(10) **Patent No.:** **US D725,965 S**  
(45) **Date of Patent:** **\*\* Apr. 7, 2015**

(54) **CUP WITH HANDLE AND LID**

(56) **References Cited**

(71) Applicant: **Anhui Inno-Sign International Co., Ltd.**, Hefei (CN)

U.S. PATENT DOCUMENTS

(72) Inventor: **Jin Bo**, Hefei (CN)

D604,103 S \* 11/2009 Alviar et al. .... D7/533  
D609,970 S \* 2/2010 Richau et al. .... D7/510  
D632,132 S \* 2/2011 George ..... D7/510

(73) Assignee: **Anhui Inno-Sign International, Co., Ltd** (CN)

FOREIGN PATENT DOCUMENTS

(\*\*) Term: **14 Years**

CN 300857661 \* 12/2008

(21) Appl. No.: **29/476,891**

\* cited by examiner

(22) Filed: **Dec. 18, 2013**

*Primary Examiner* — Susan Bennett Hattan

(51) **LOC (10) Cl.** ..... **07-01**

*Assistant Examiner* — Leanne Was

(52) **U.S. Cl.**

(74) *Attorney, Agent, or Firm* — Richards Patent Law P.C.

USPC ..... **D7/510**

(57) **CLAIM**

(58) **Field of Classification Search**

The ornamental design for a cup with handle and lid, as shown and described.

USPC ..... D7/300, 302, 303, 304, 316, 317, 318,  
D7/321, 322, 396.1, 396.2, 500, 507, 509,  
D7/510, 511, 523, 533, 535, 543, 601, 602,  
D7/605, 608, 619.1, 622, 624.3, 629;  
D9/434, 435, 440, 443, 447, 449, 500,  
D9/503, 504, 527, 528, 529, 530, 531, 534,  
D9/715, 716, 742; 215/200, 303, 305, 306,  
215/344, 386, 387, 396, 398; 220/288,  
220/592.16, 592.17, 592.2, 703, 705, 713,  
220/715

**DESCRIPTION**

FIG. 1 is a perspective view of the cup with handle and lid.  
FIG. 2 is a front side view of the cup with handle and lid;  
FIG. 3 is a back side view thereof;  
FIG. 4 is a left side view thereof;  
FIG. 5 is a right side view thereof  
FIG. 6 is a top view thereof; and,  
FIG. 7 is a bottom view thereof.

See application file for complete search history.

**1 Claim, 6 Drawing Sheets**

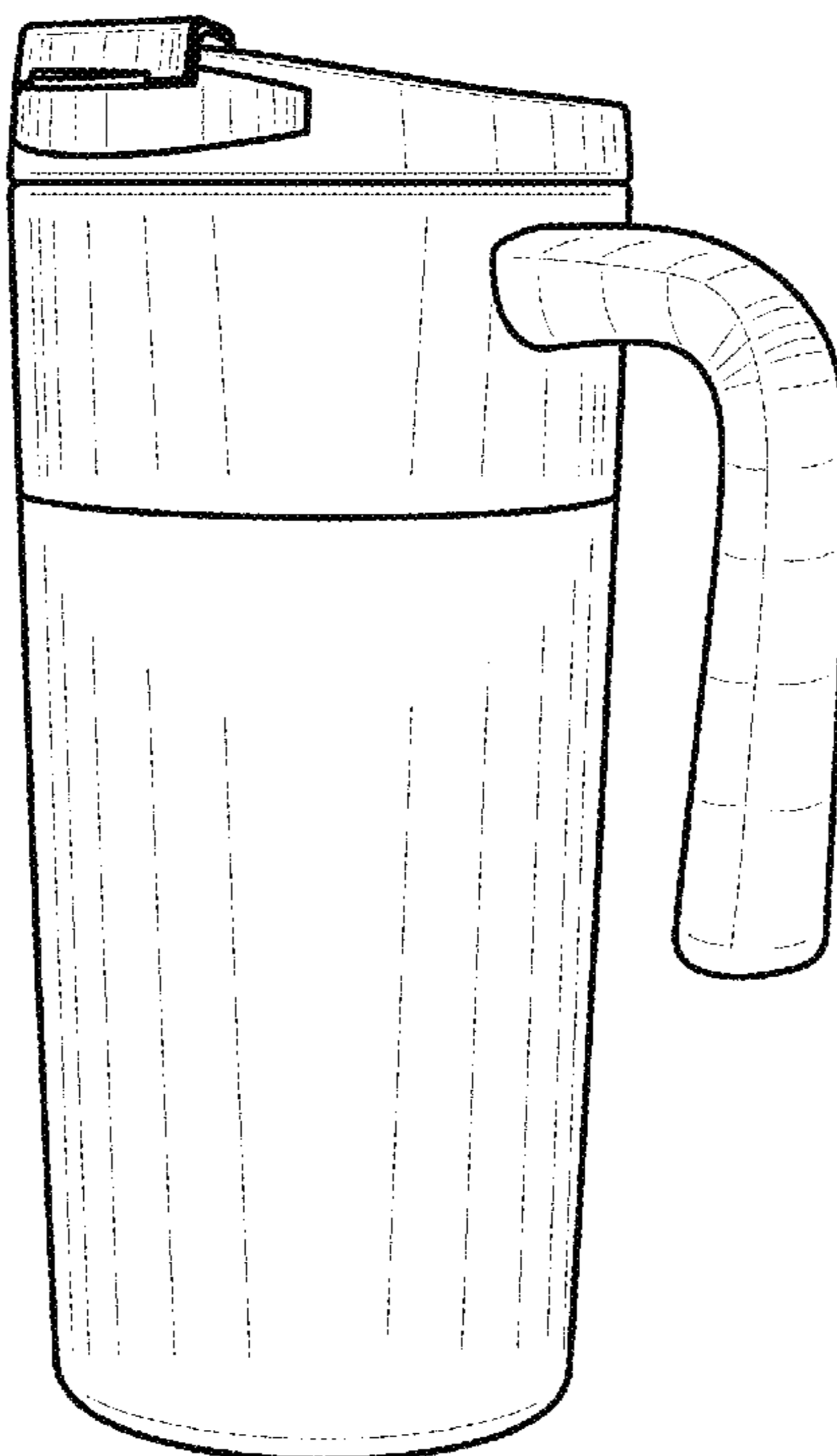

FIG. 1

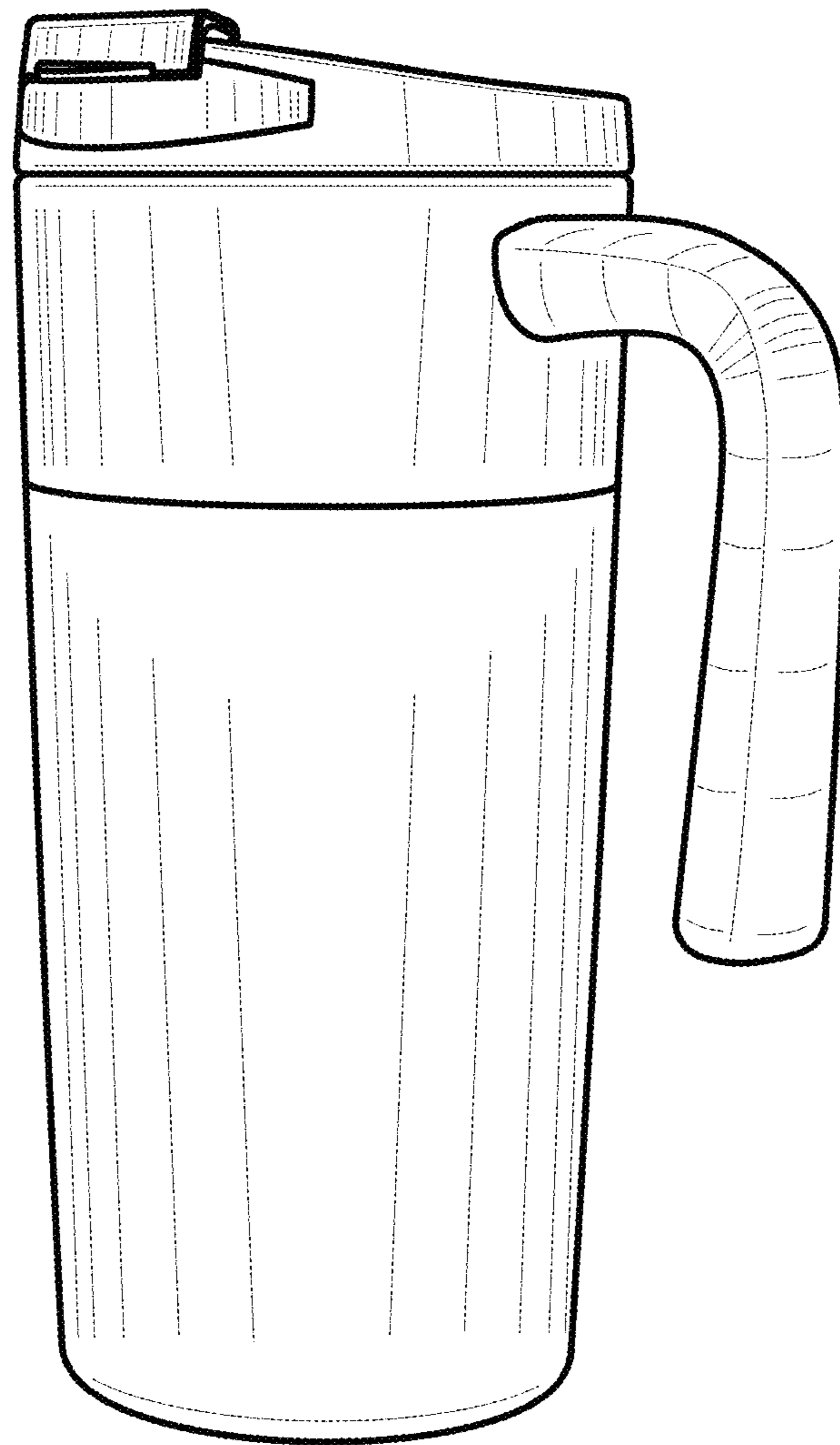

FIG.2

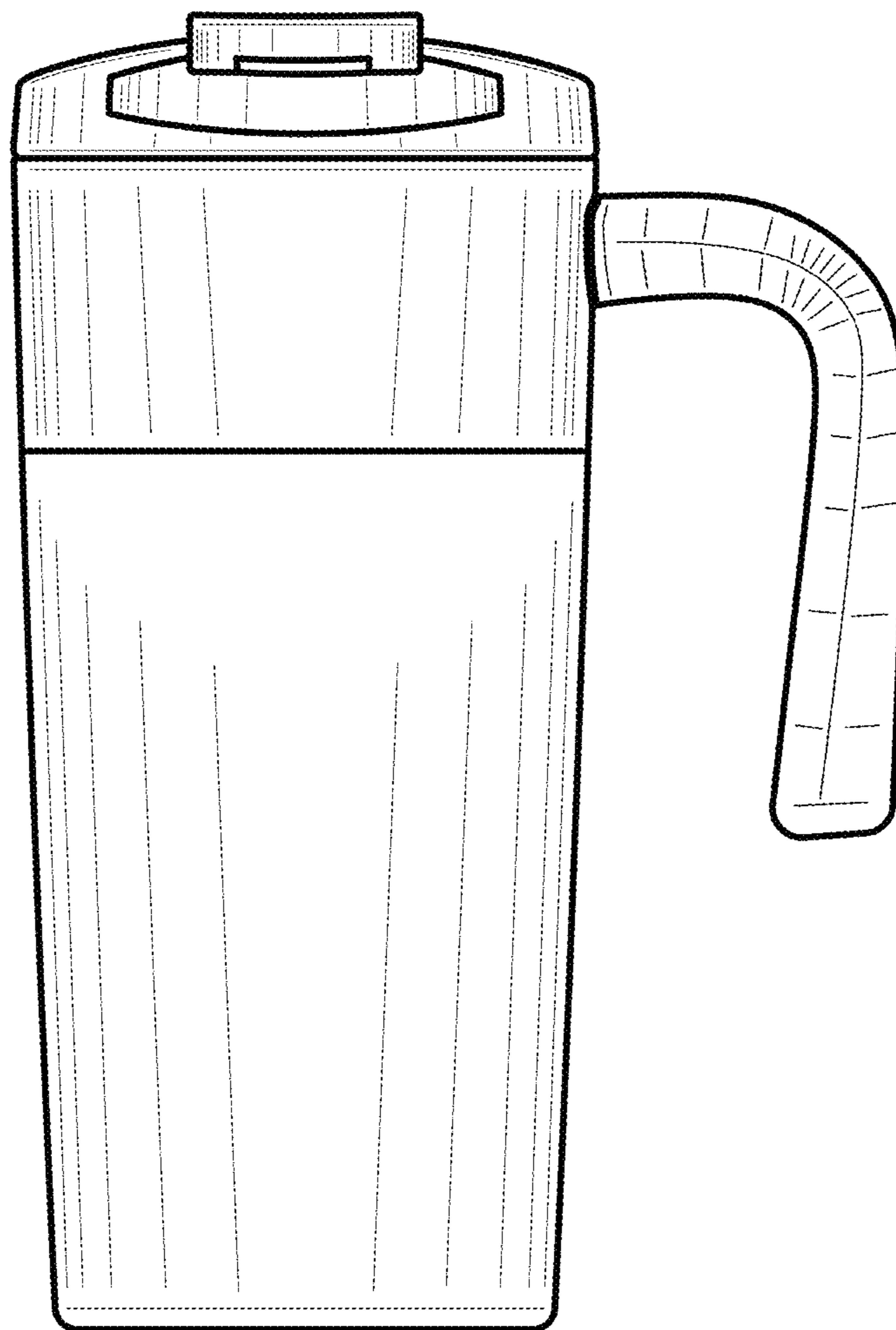

FIG.3

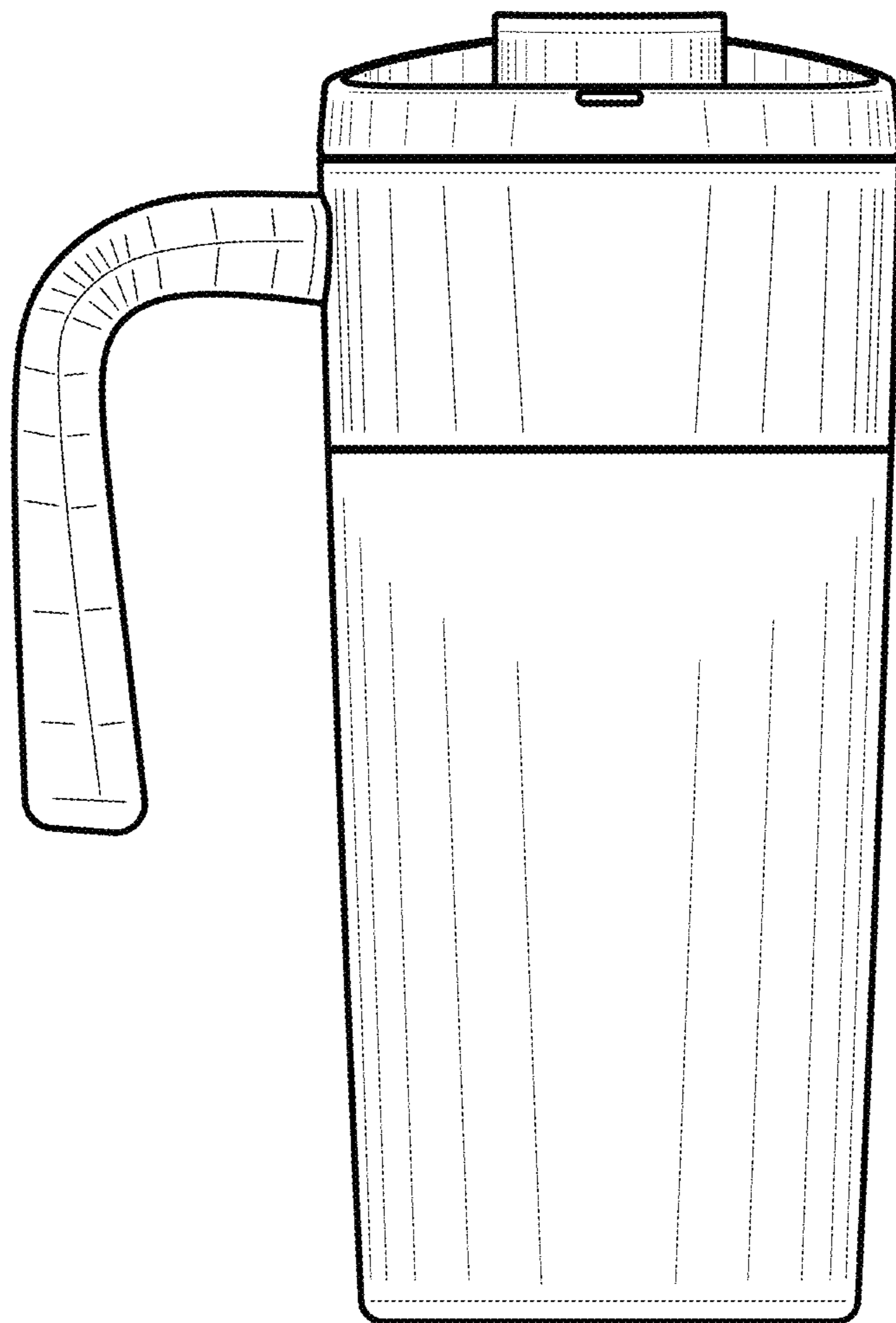

FIG.4

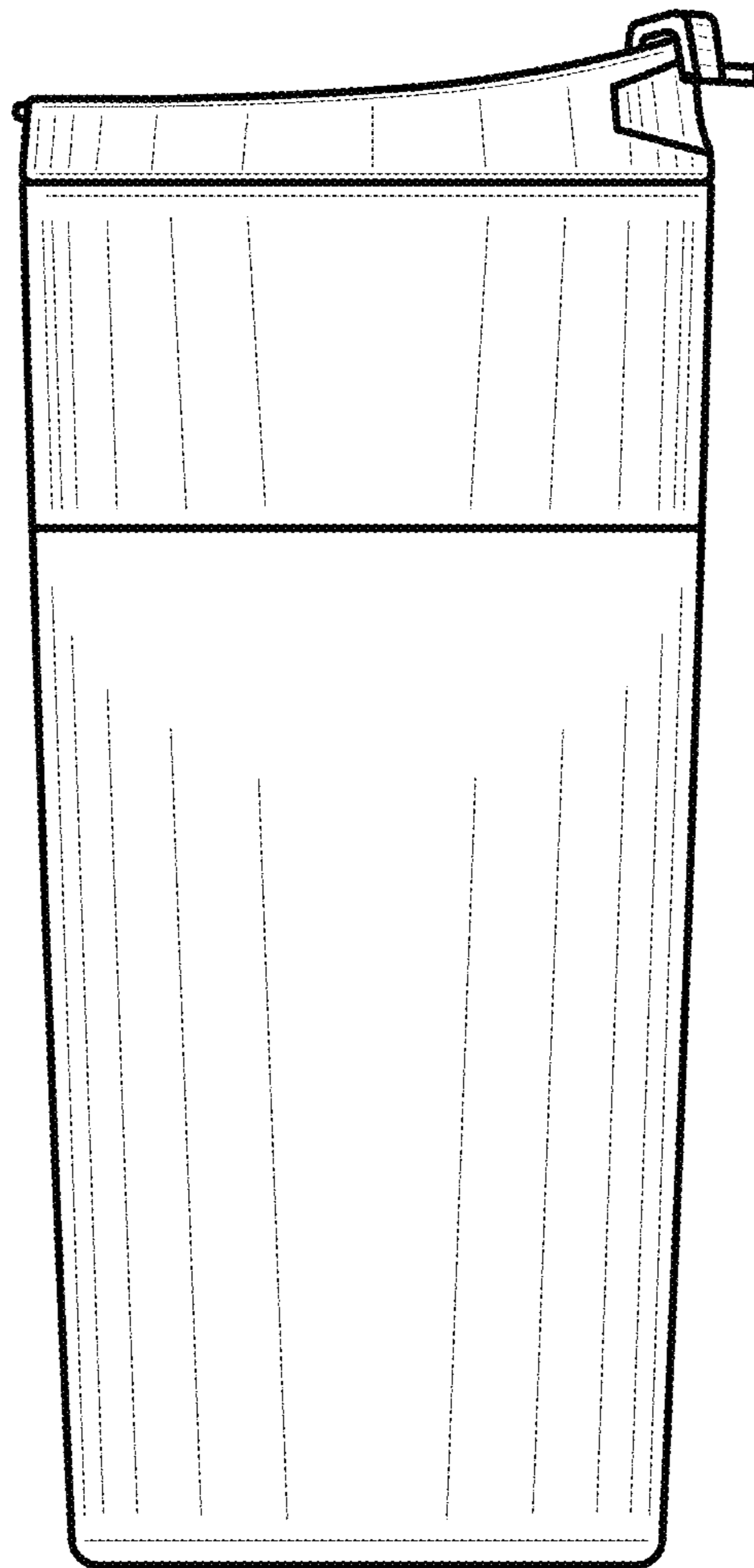

FIG. 5

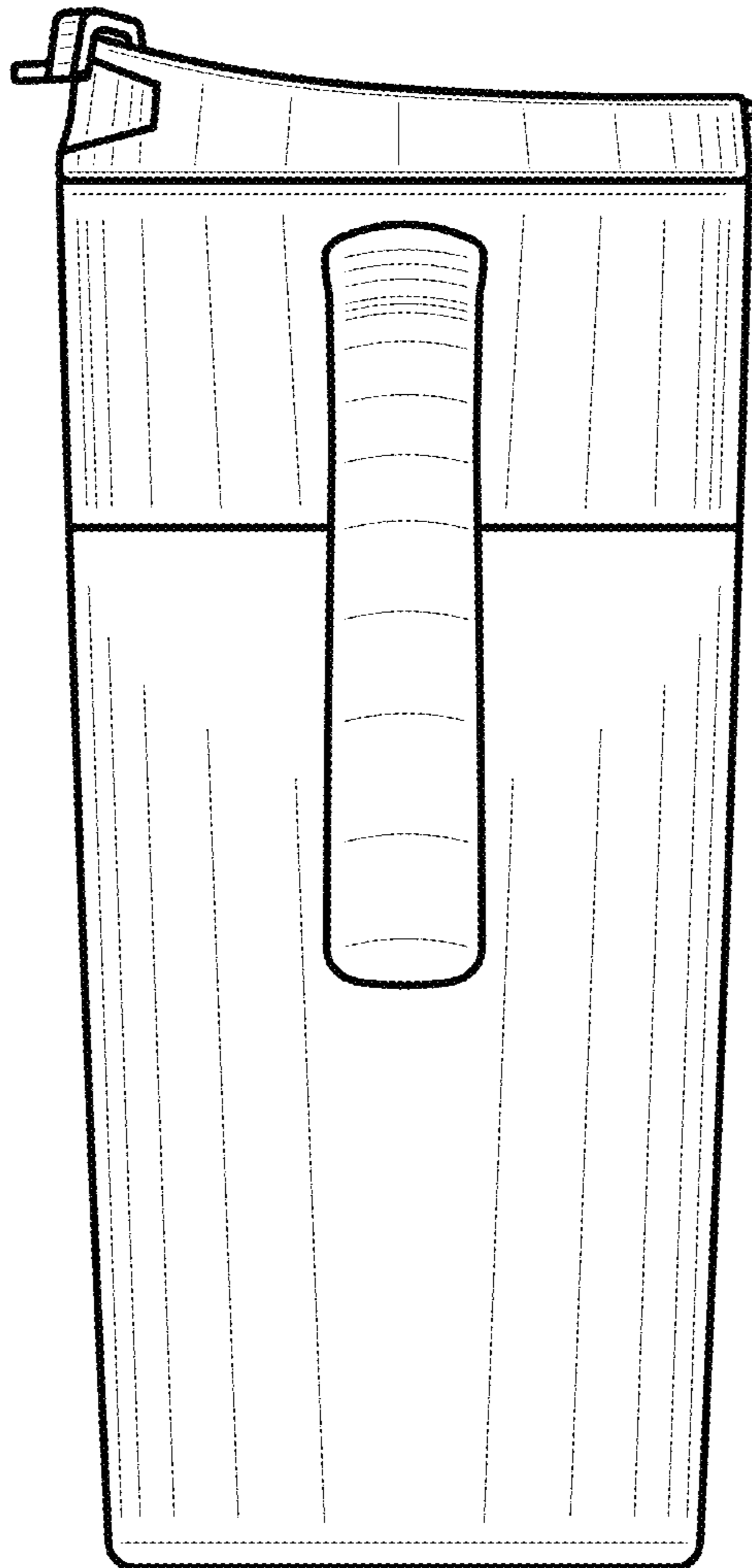

FIG.6

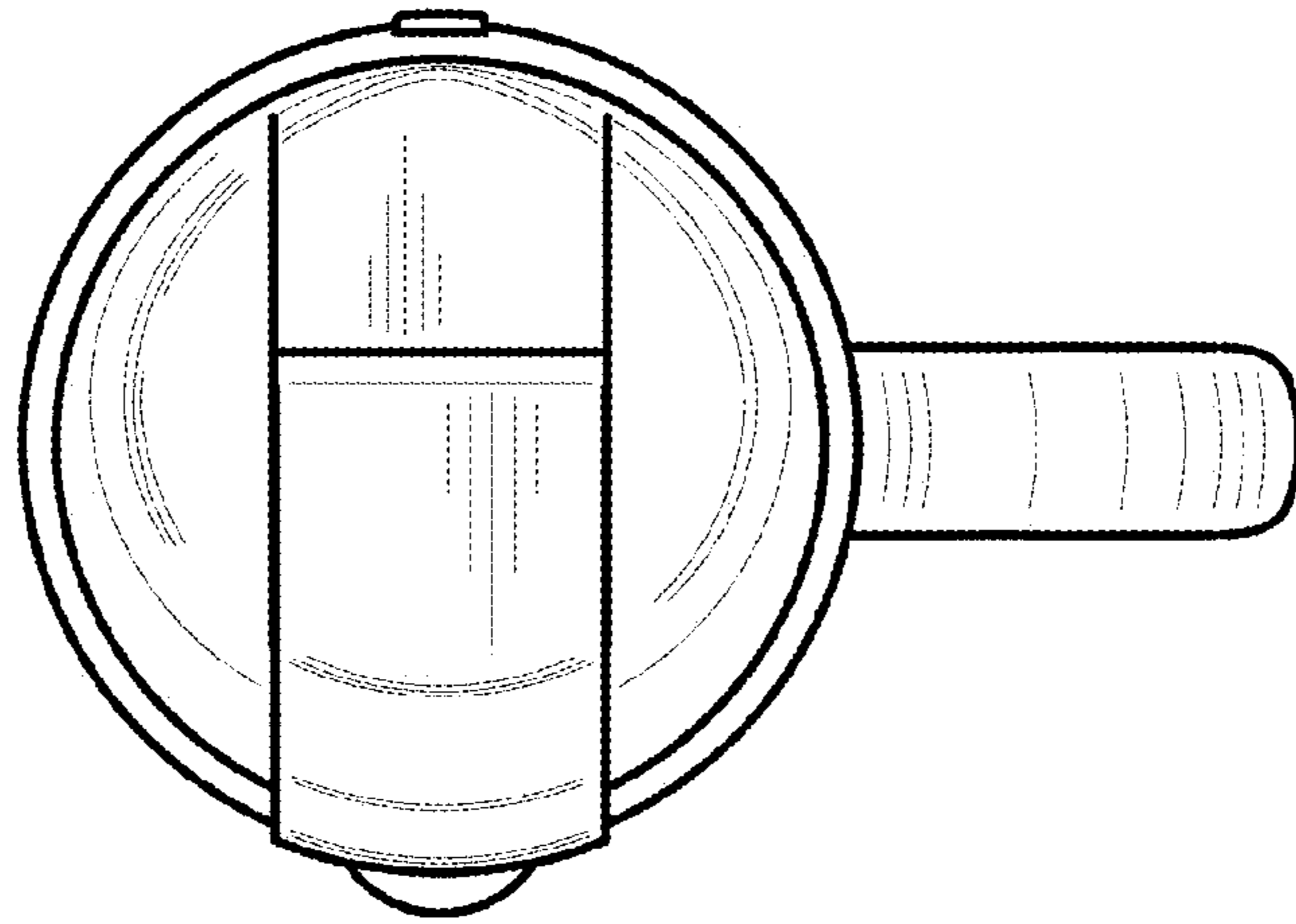

FIG.7

