



US00D725809S

(12) **United States Design Patent**
Ford

(10) **Patent No.:** **US D725,809 S**
(45) **Date of Patent:** **** Mar. 31, 2015**

- (54) **ILLUMINATING DEVICE**
- (75) Inventor: **Timothy D. F. Ford**, Beaconsfield (CA)
- (73) Assignee: **The Flewelling Ford Family Trust**,
Beaconsfield (CA)
- (**) Term: **14 Years**
- (21) Appl. No.: **29/431,226**
- (22) Filed: **Sep. 5, 2012**
- (51) **LOC (10) Cl.** **26-02**
- (52) **U.S. Cl.**
USPC **D26/37**
- (58) **Field of Classification Search**
USPC D26/37, 38, 39, 46, 50, 51, 40-42;
362/157, 158, 183, 184, 194-196, 202,
362/201, 207, 208, 253; D8/356
See application file for complete search history.

- D498,553 S * 11/2004 Lee D26/37
- D498,864 S 11/2004 Lee
- D521,587 S * 5/2006 Smith D21/789
- 7,048,407 B2 5/2006 Kumthampinij et al.
- D542,453 S 5/2007 Osiecki et al.
- D551,788 S * 9/2007 Bao D26/38
- D553,480 S * 10/2007 Kelleghan D8/356
- 7,438,431 B2 * 10/2008 Ford et al. 362/116
- D584,437 S * 1/2009 Barber et al. D26/37
- D614,017 S * 4/2010 Bender D8/356
- D620,164 S * 7/2010 Chen D26/60
- D652,971 S * 1/2012 Ormsbee et al. D26/38
- D673,316 S * 12/2012 Oshima et al. D26/50
- 2004/0201983 A1 10/2004 Yu

* cited by examiner

Primary Examiner — Ian Simmons

Assistant Examiner — Carissa C Fitts

(74) *Attorney, Agent, or Firm* — Goudreau Gage Dubuc;
Hugh Mansfield

(57) **CLAIM**

The ornamental design for an illuminating device, as shown and described.

(56) **References Cited**

U.S. PATENT DOCUMENTS

- 2,591,419 A 4/1952 Gheorhiu
- D289,931 S 5/1987 Grae
- 4,692,846 A 9/1987 Johnson
- D351,479 S 10/1994 Meyer
- 6,190,018 B1 2/2001 Parsons et al.
- D443,370 S * 6/2001 Yu D26/37
- 6,299,323 B1 10/2001 Yu et al.
- D469,023 S * 1/2003 Mah D10/2
- 6,550,930 B1 4/2003 Portouche
- 6,591,646 B1 7/2003 Huang
- 6,637,910 B1 10/2003 Mehler et al.
- 6,685,338 B1 2/2004 Lewis et al.
- D495,073 S * 8/2004 Kumthampinij et al. D26/37
- D495,075 S 8/2004 Oas

DESCRIPTION

FIG. 1 is a perspective view of the illuminating device;
FIG. 2 is a front view thereof;
FIG. 3 is a rear view thereof;
FIG. 4 is a top plan view thereof;
FIG. 5 is a bottom view thereof;
FIG. 6 is a left side view thereof; and,
FIG. 7 is a right side view thereof.
The broken line showing is for environmental purposes only and forms no part of the claimed design.

1 Claim, 6 Drawing Sheets

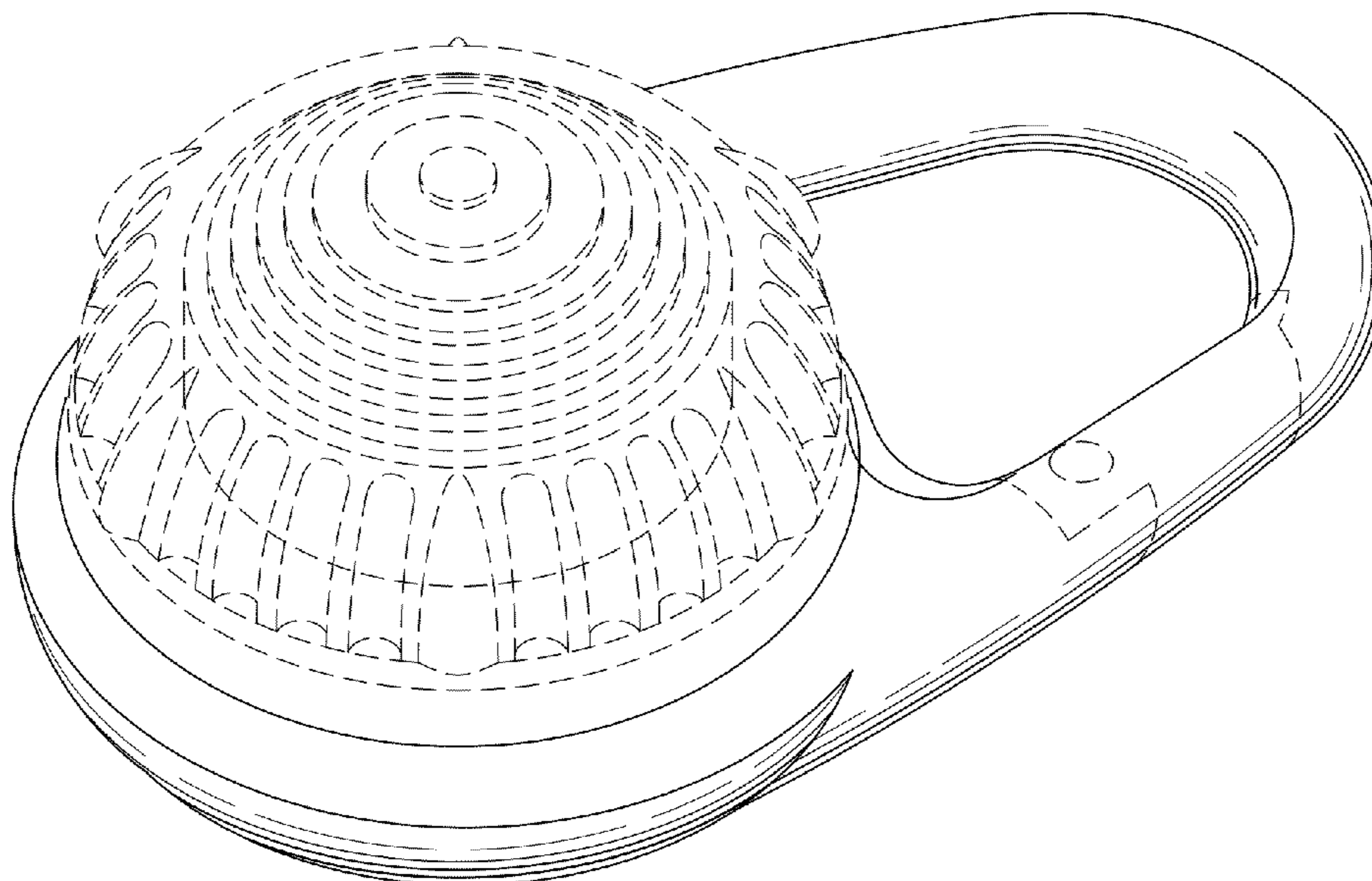

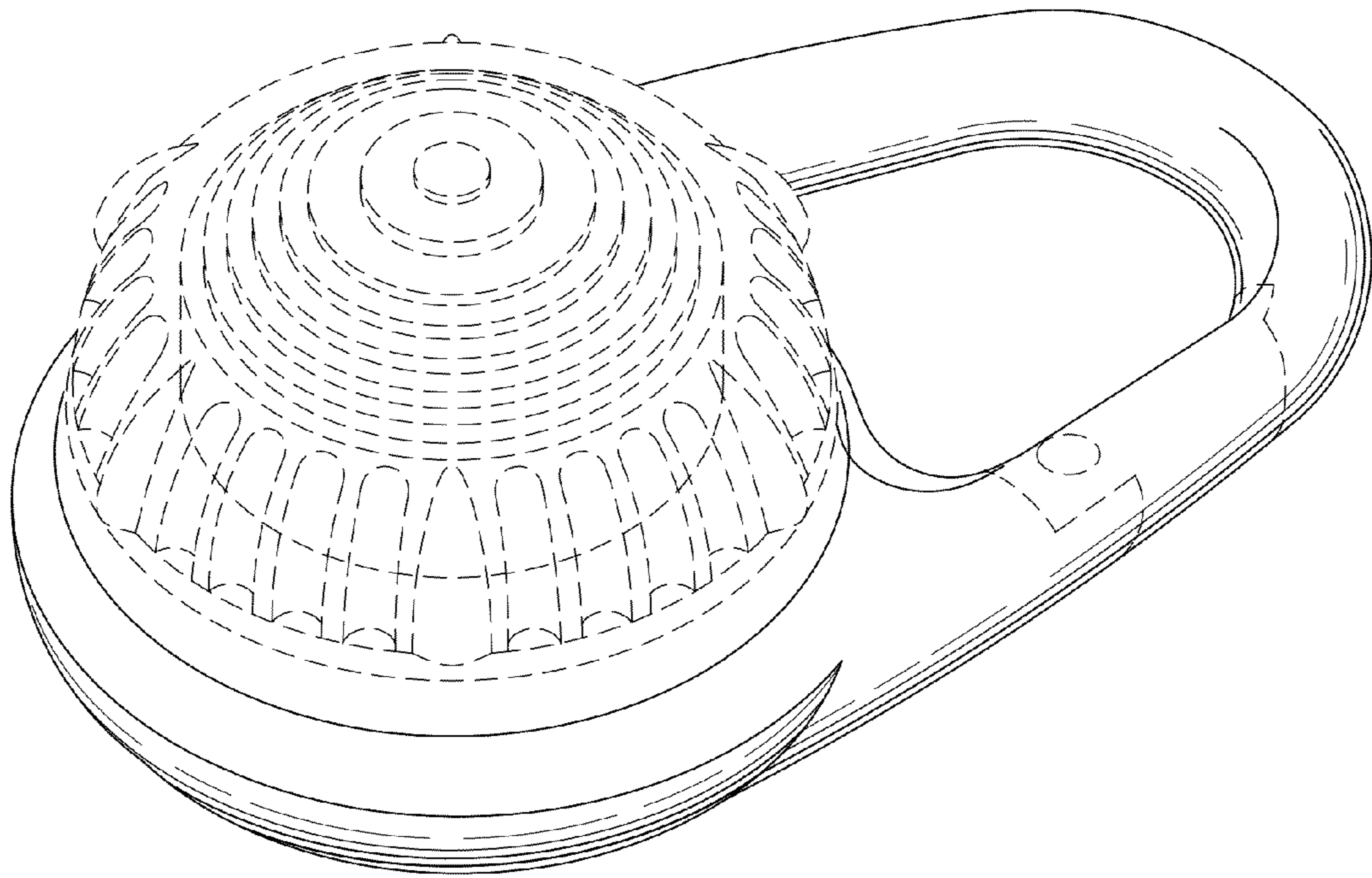

Fig-1

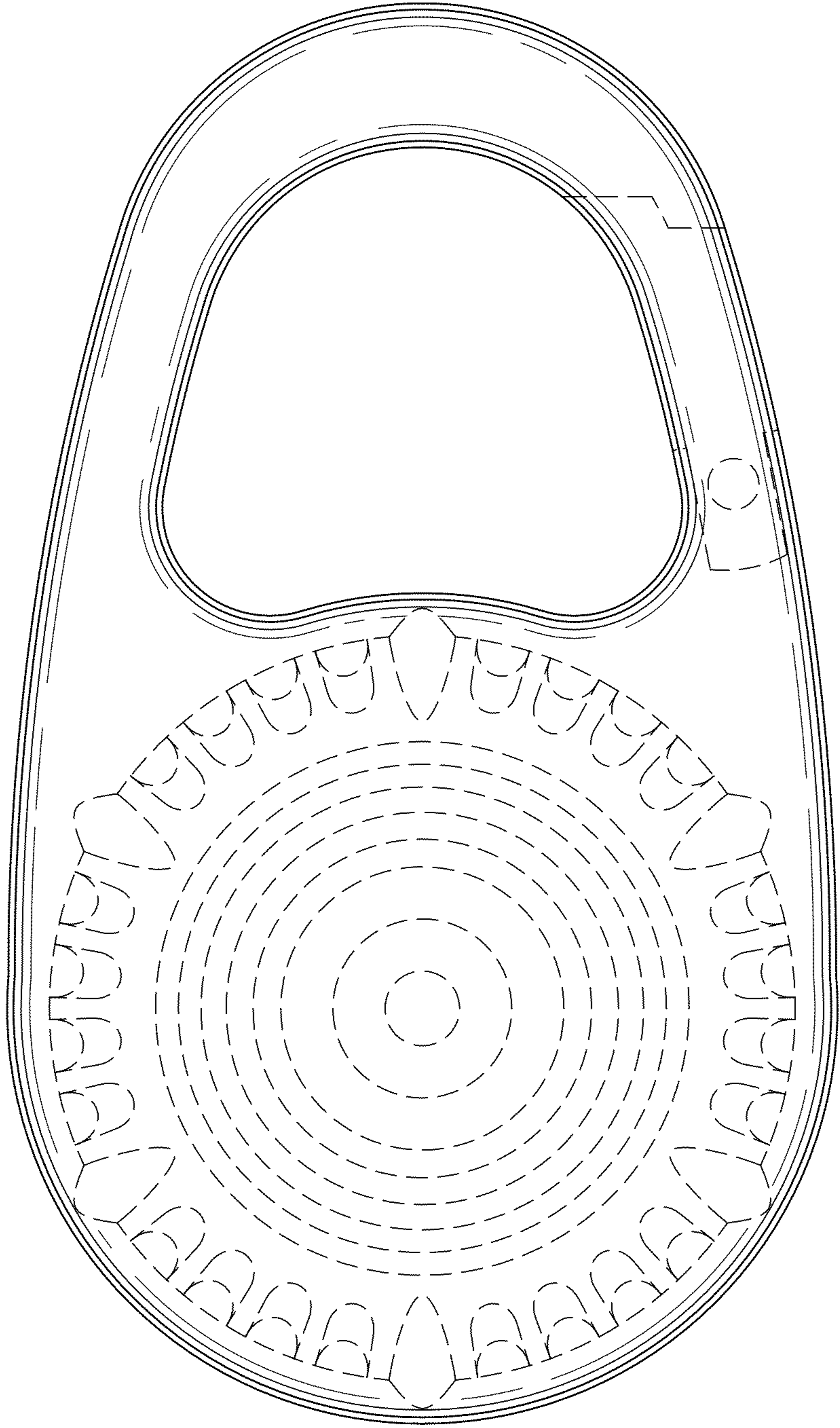

Fig-2

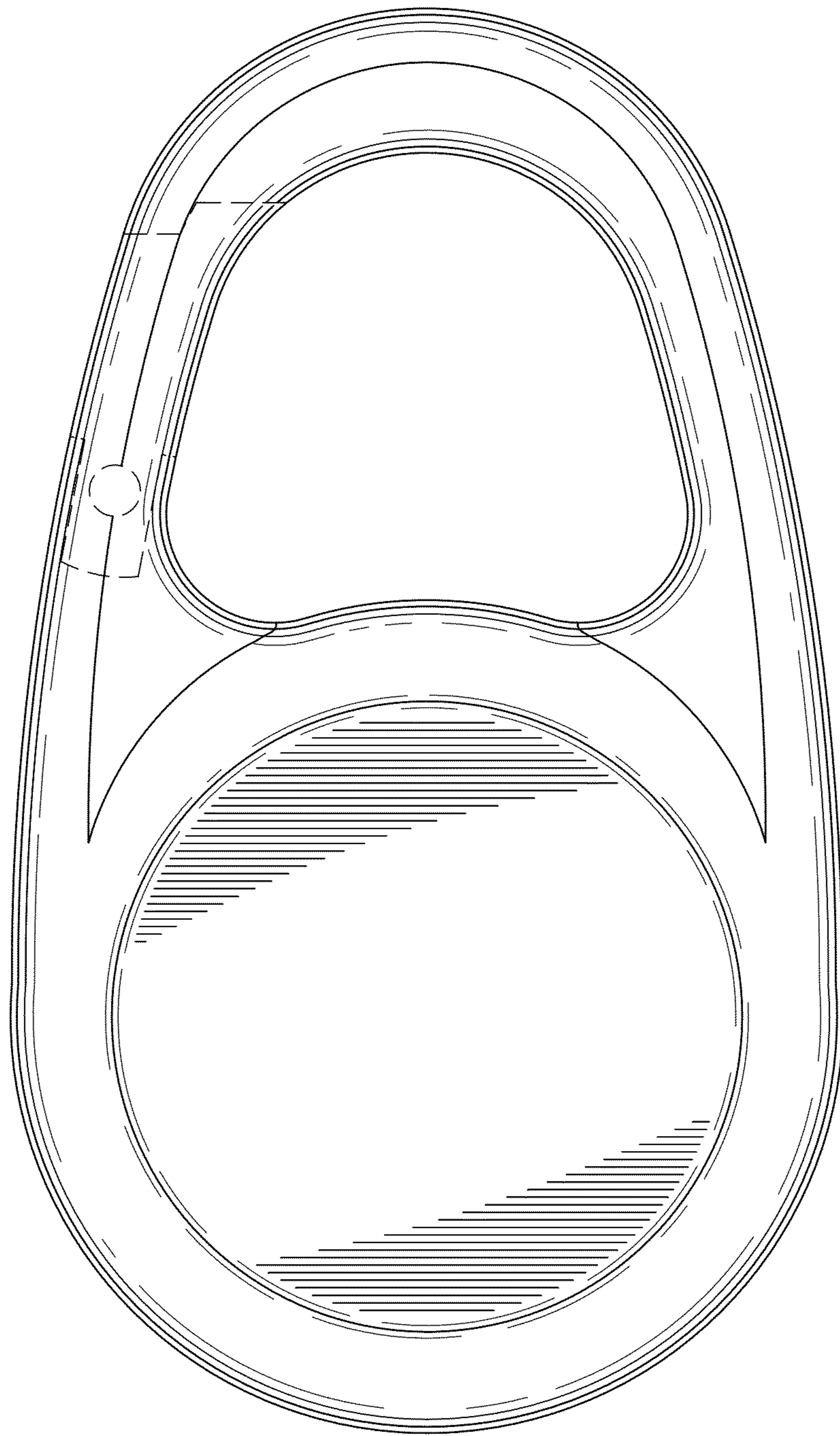

Fig. 3

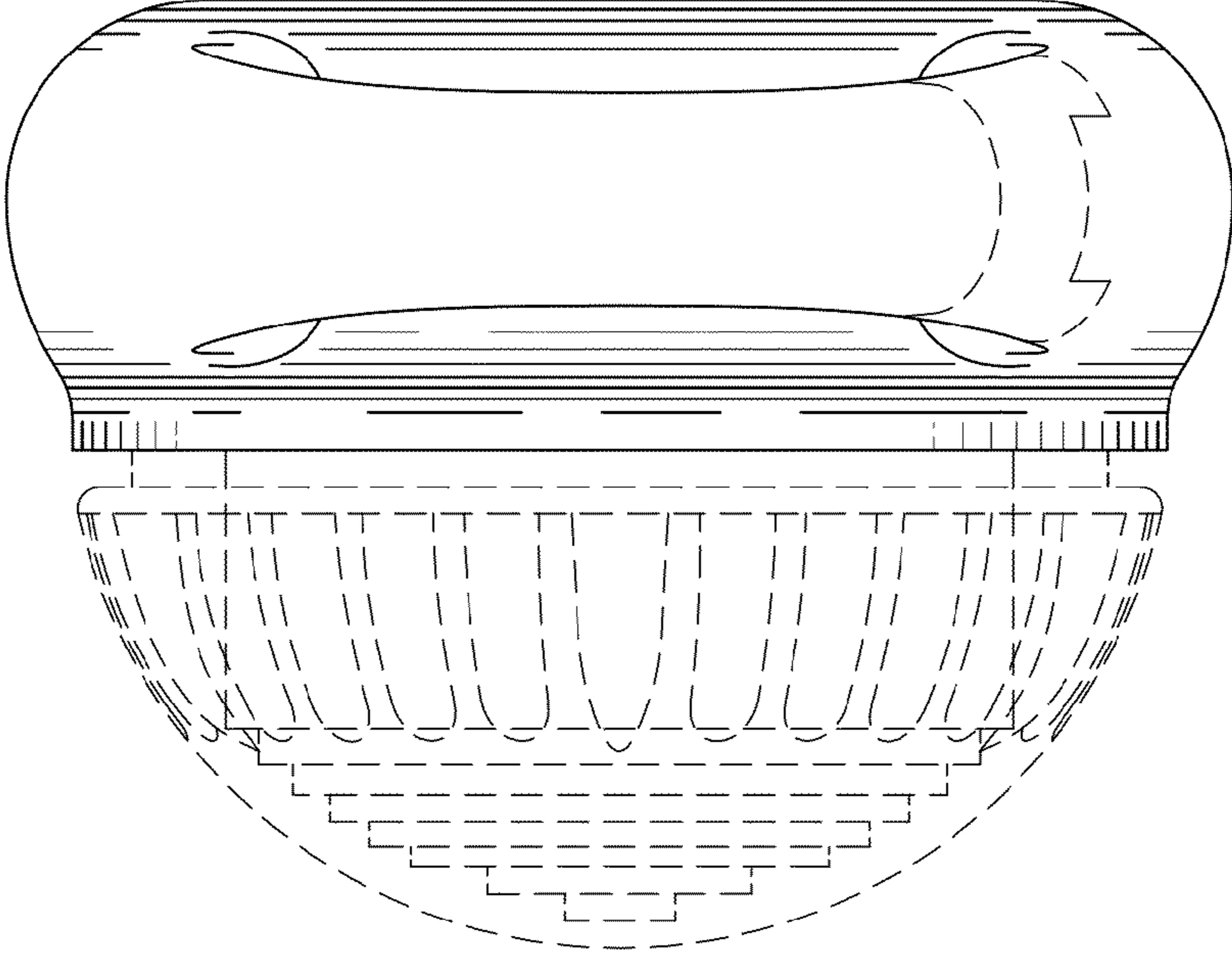

Fig-4

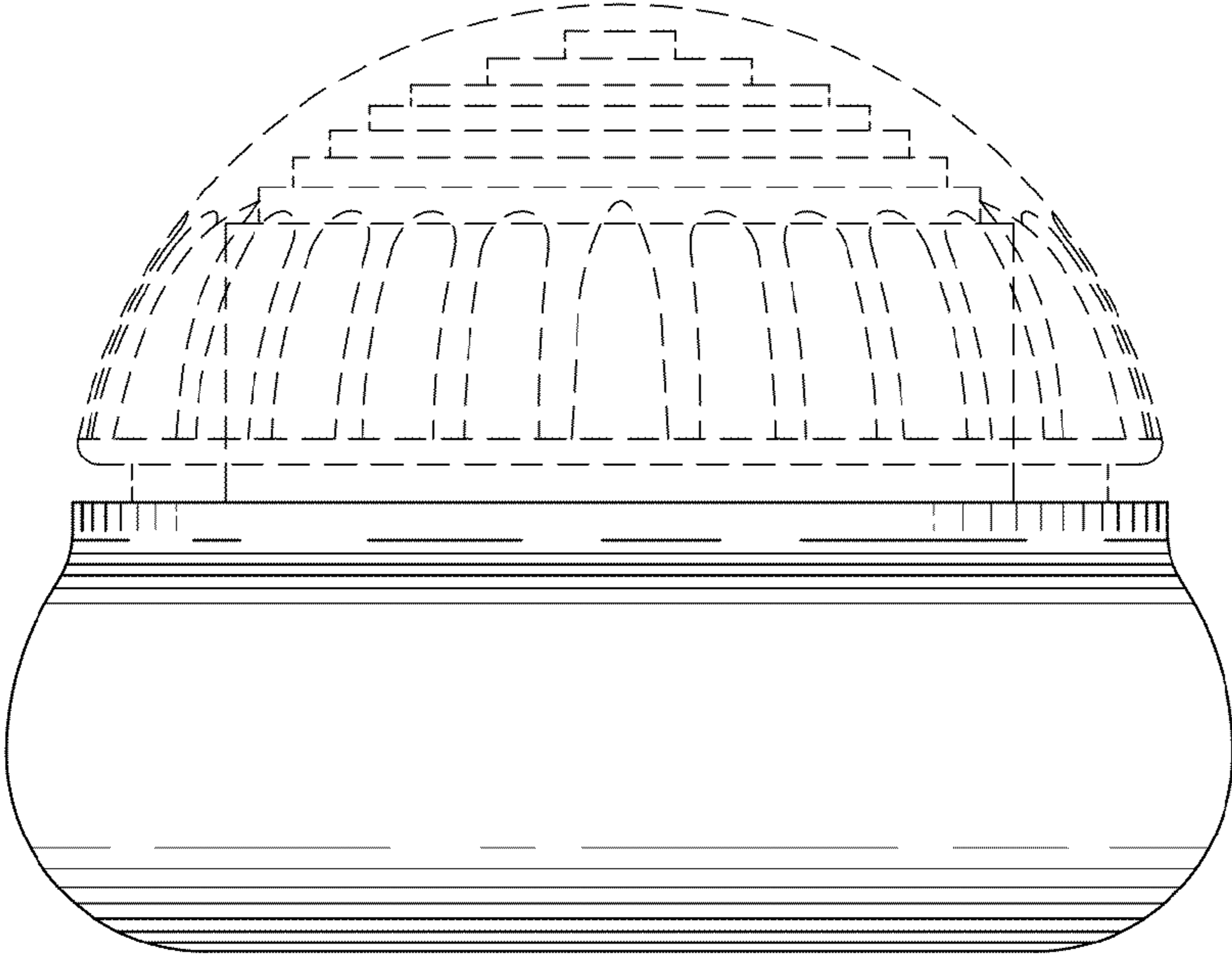

Fig-5

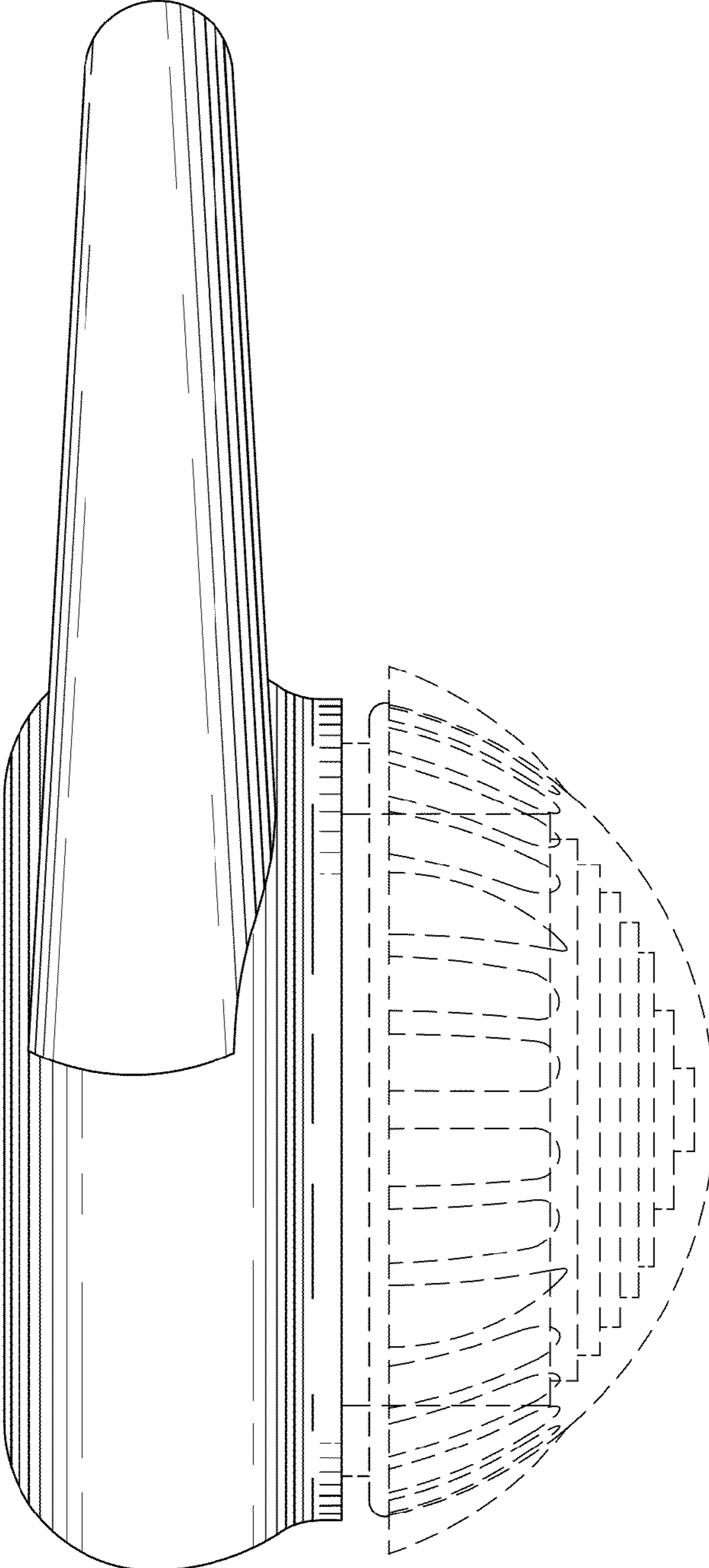

Fig. 6

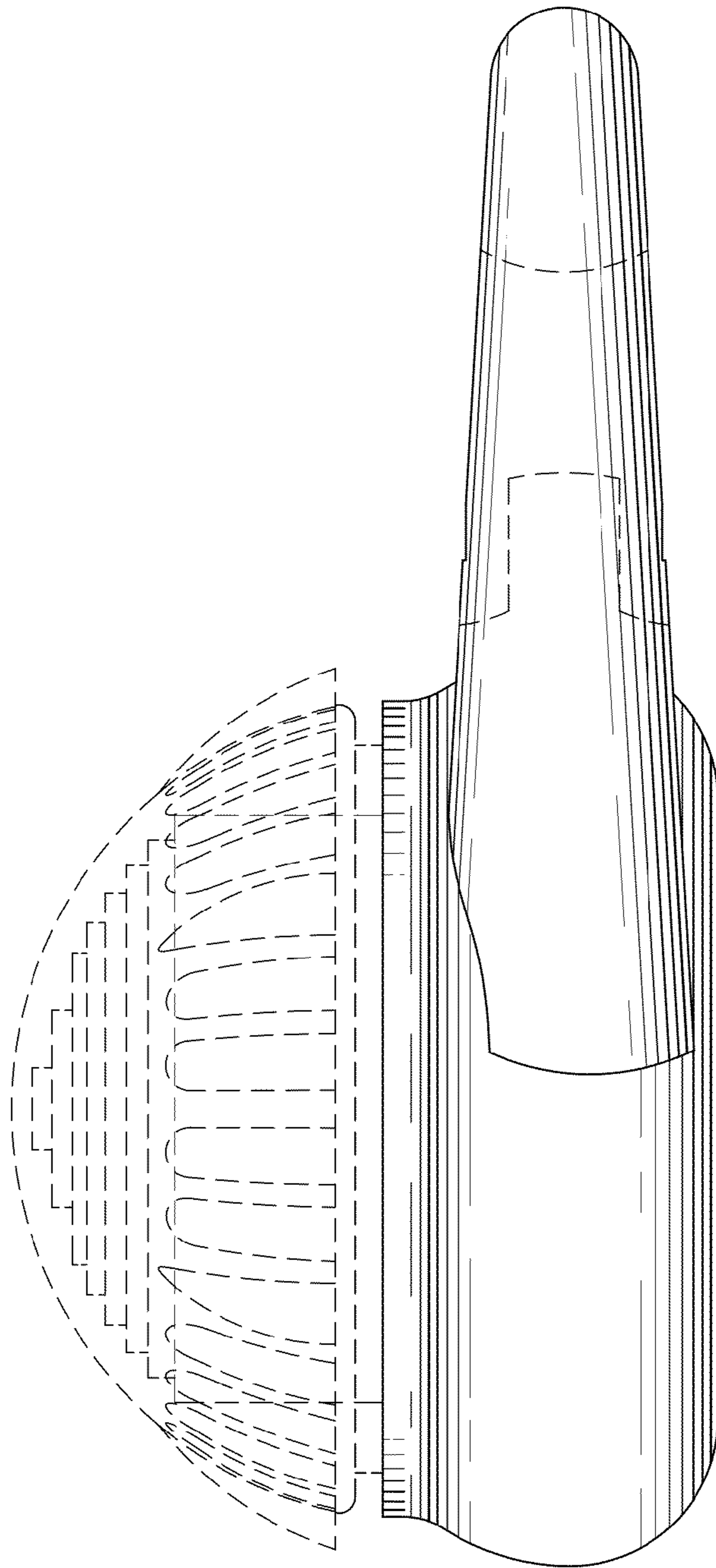

Fig-7