



US00D725743S

(12) **United States Design Patent**
Richter et al.

(10) **Patent No.:** **US D725,743 S**

(45) **Date of Patent:** **** *Mar. 31, 2015**

(54) **ELECTROSTATIC SPRAY GUN**

(56) **References Cited**

(71) Applicant: **Graco Minnesota Inc.**, Minneapolis, MN (US)

U.S. PATENT DOCUMENTS

(72) Inventors: **Mark C. Richter**, River Falls, WI (US);
Elisa J. McCline, Elk River, MN (US);
Tamara M. Bentley, Minneapolis, MN (US)

D313,064	S	*	12/1990	Lind et al.	D23/226
D350,387	S	*	9/1994	Feitel et al.	D23/226
5,857,625	A	*	1/1999	Klein et al.	239/289
D441,833	S	*	5/2001	Haas	D23/226
D457,599	S	*	5/2002	Karwoski et al.	D23/226
6,758,424	B2		7/2004	Lind et al.		
D604,394	S	*	11/2009	Wang	D23/226
D608,858	S	*	1/2010	Baltz et al.	D23/226
D641,067	S	*	7/2011	Wang	D23/226
D649,221	S	*	11/2011	Sinders et al.	D23/226
8,496,194	B2	*	7/2013	Baltz	239/690

(73) Assignee: **Graco Minnesota Inc.**, Minneapolis, MN (US)

* cited by examiner

(*) Notice: This patent is subject to a terminal disclaimer.

Primary Examiner — Robin V Webster
(74) *Attorney, Agent, or Firm* — Douglas B. Farrow

(**) Term: **14 Years**

(57) **CLAIM**
The ornamental design for an electrostatic spray gun, as shown and described.

(21) Appl. No.: **29/435,891**

DESCRIPTION

(22) Filed: **Oct. 30, 2012**

FIG. 1 is a front right isometric view of an electrostatic spray gun;
FIG. 2 is a left side view thereof;
FIG. 3 is a back view thereof,
FIG. 4 is a front side view thereof;
FIG. 5 is a top view thereof;
FIG. 6 is a right side view thereof; and,
FIG. 7 is a bottom view of an electrostatic spray gun.

(51) **LOC (10) Cl.** **23-01**

(52) **U.S. Cl.**
USPC **D23/226**

(58) **Field of Classification Search**
USPC D23/213, 223, 226; 239/526, 690, 691,
239/290, 291; 361/227, 228

See application file for complete search history.

1 Claim, 7 Drawing Sheets

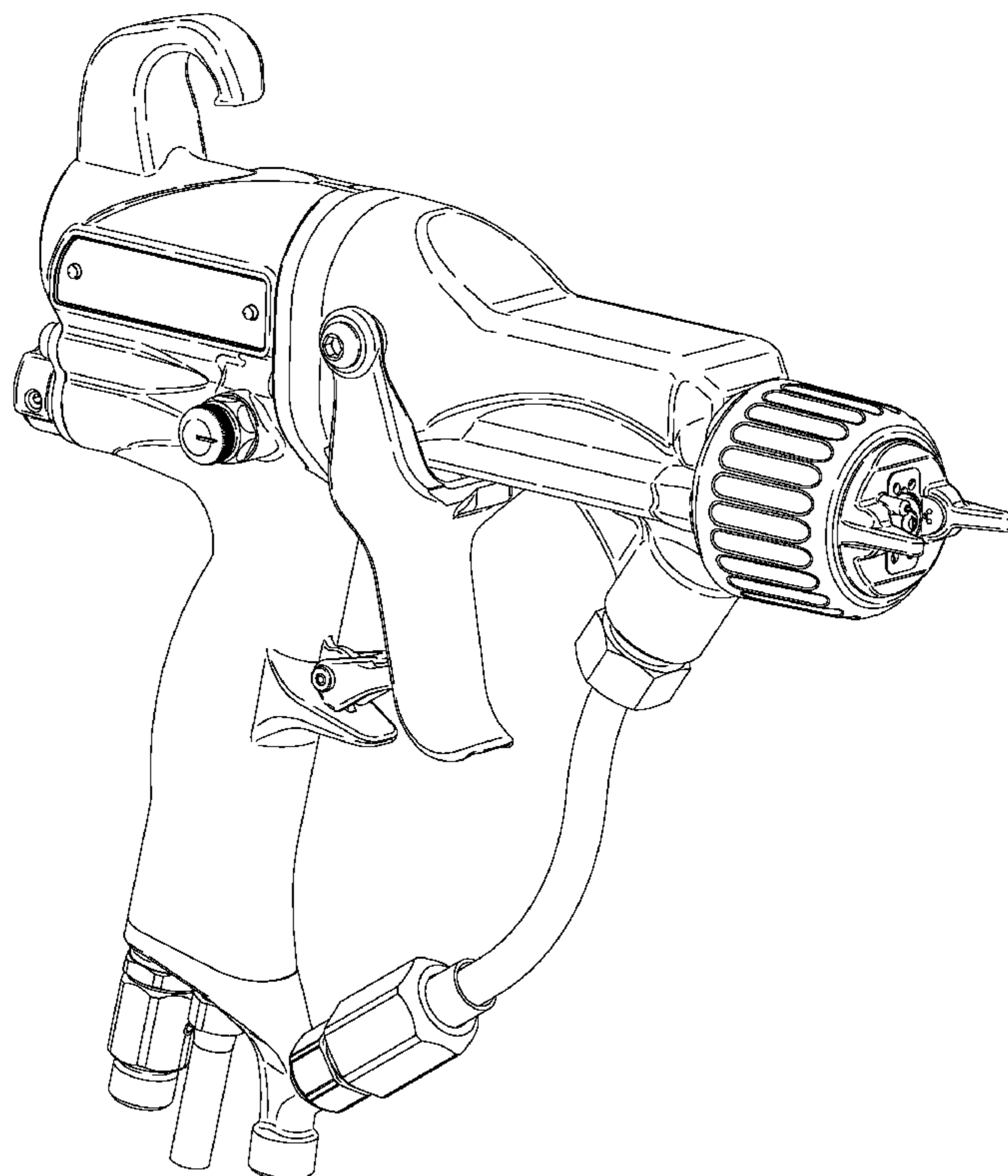

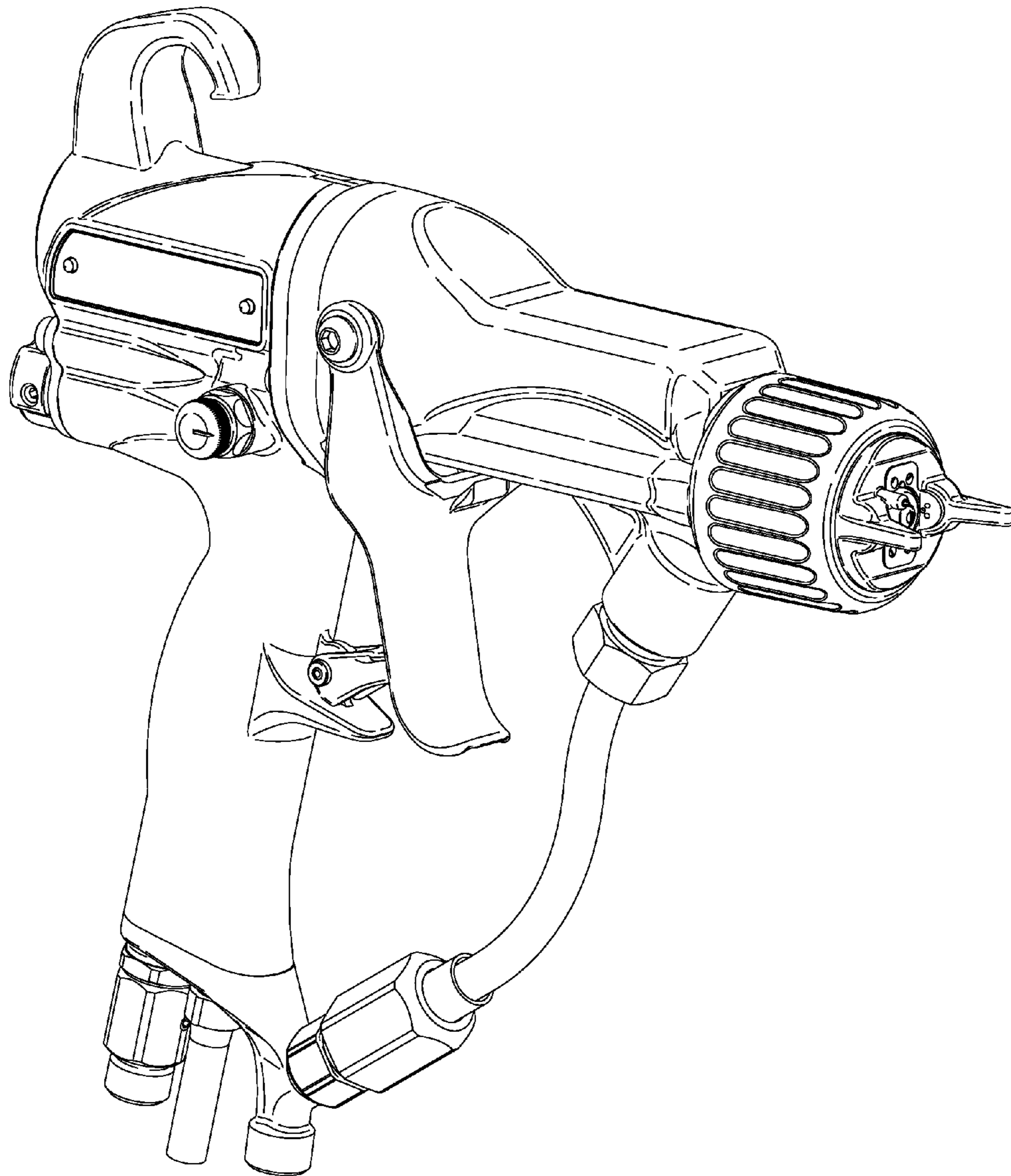

FIG. 1

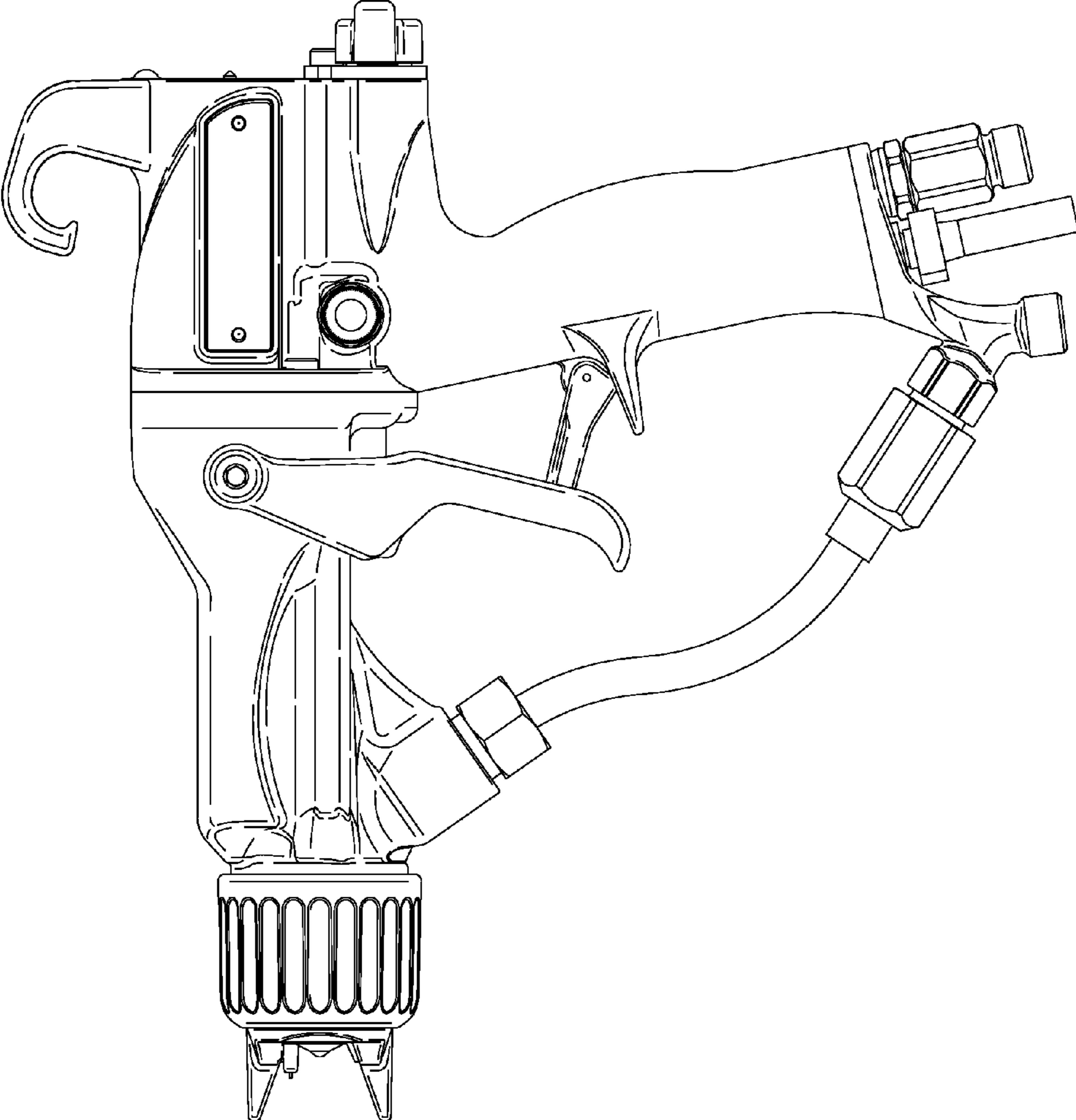

FIG. 2

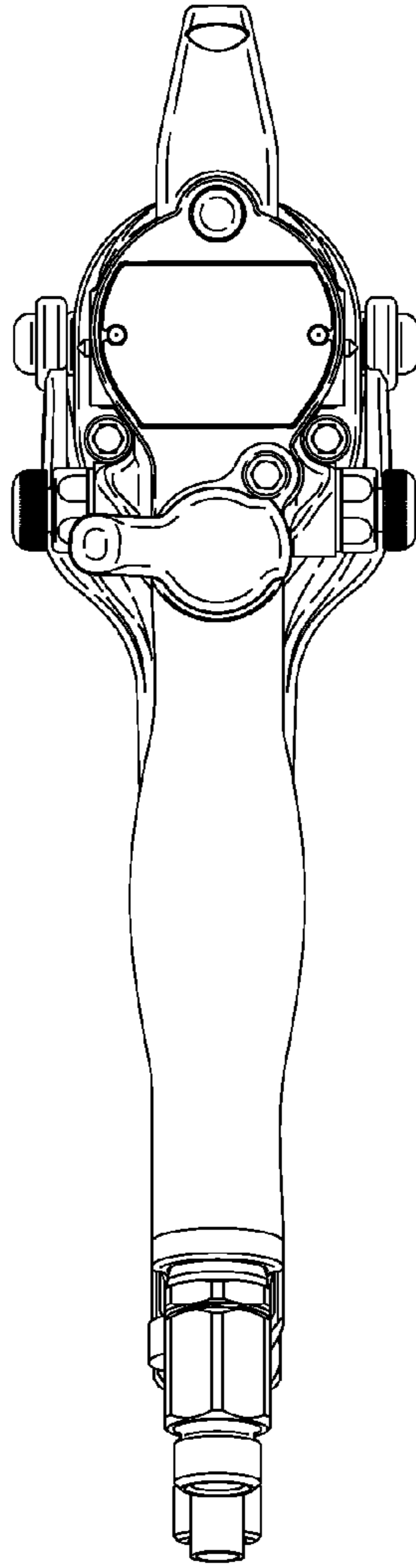

FIG. 3

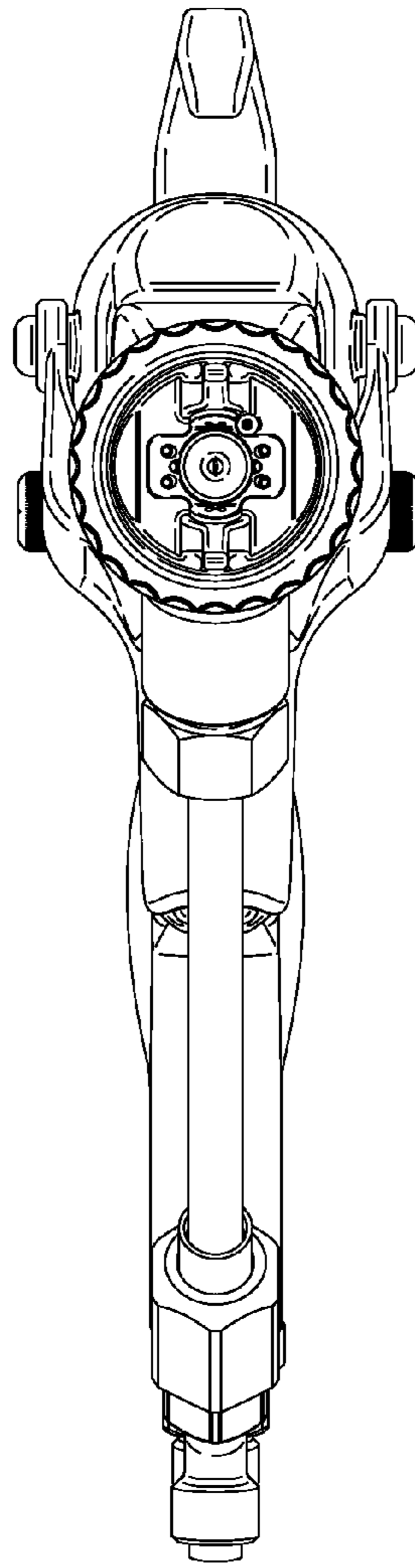

FIG. 4

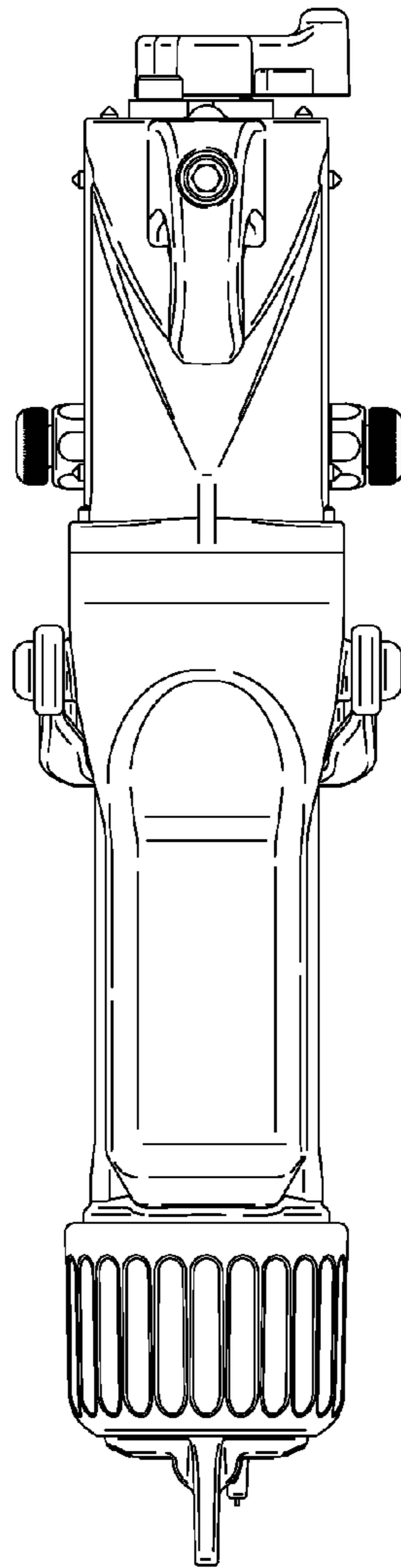

FIG. 5

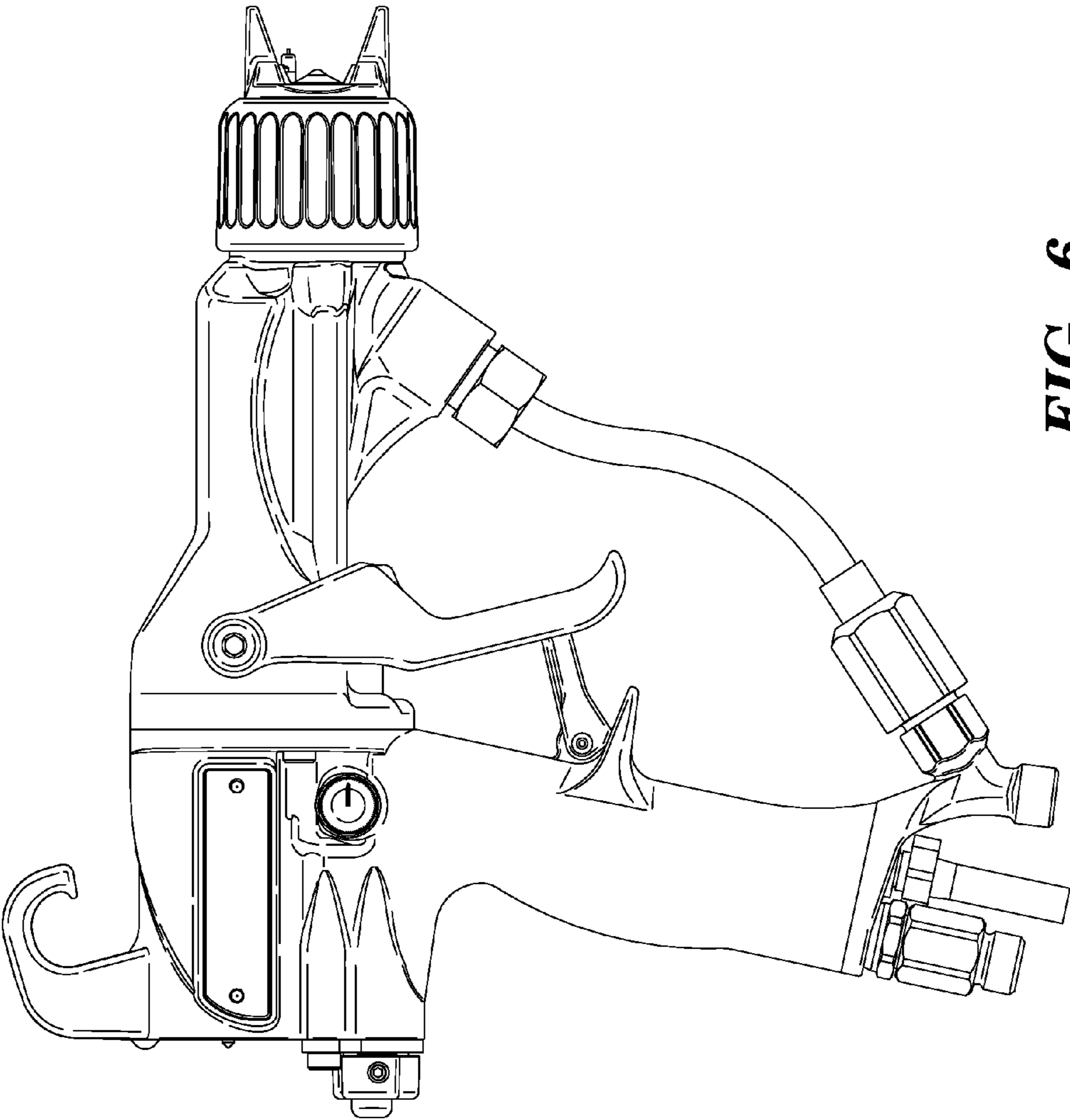

FIG. 6

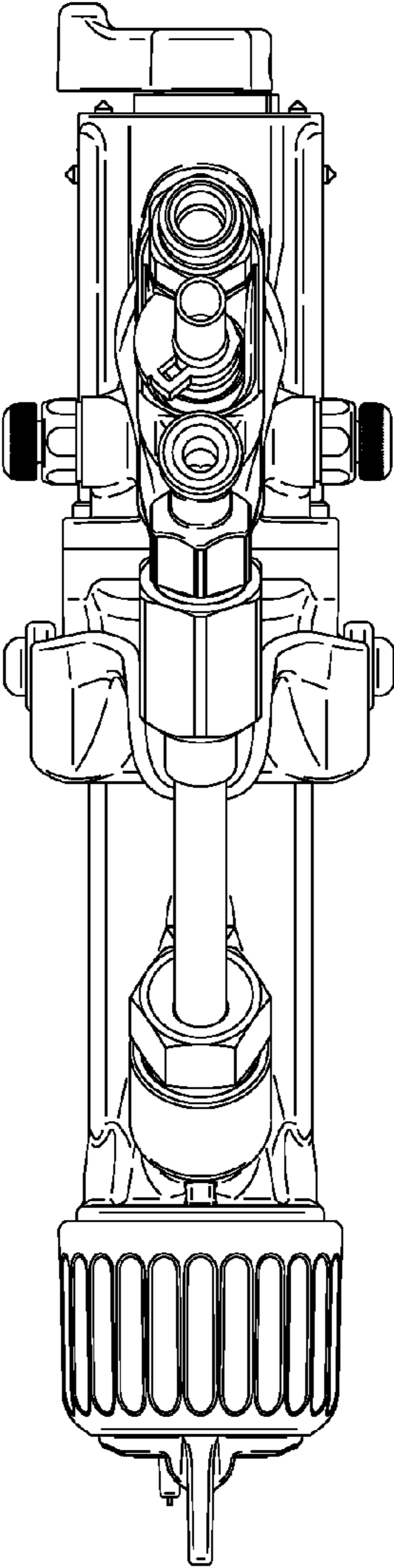

FIG. 7