



US00D725654S

(12) **United States Design Patent**  
**Lee et al.**

(10) **Patent No.:** **US D725,654 S**  
(45) **Date of Patent:** **\*\* Mar. 31, 2015**

(54) **HEAD MOUNTED DISPLAY DEVICE**

(71) Applicant: **LG Electronics Inc.**, Seoul (KR)

(72) Inventors: **Hophil Lee**, Seoul (KR); **Junseop Lee**, Seoul (KR); **Seungbeom Park**, Seoul (KR)

(73) Assignee: **LG Electronics Inc.**, Seoul (KR)

(\*\*) Term: **14 Years**

(21) Appl. No.: **29/503,522**

(22) Filed: **Sep. 26, 2014**

(30) **Foreign Application Priority Data**

Mar. 27, 2014 (KR) ..... 30-2014-0015430

(51) **LOC (10) Cl.** ..... **14-02**

(52) **U.S. Cl.**  
USPC ..... **D14/372**

(58) **Field of Classification Search**  
CPC ..... G02B 27/017; G02B 27/0158; G02B 27/0161; G02B 27/0181; G02B 27/0185; G02B 27/0189  
USPC ..... D14/372, 496, 432, 371, 125, 126, 129, D14/299; D16/300-342; 351/158, 153, 144; 345/7-9, 905; 455/344; 348/115, 53, 348/121, 739  
See application file for complete search history.

(56) **References Cited**

**U.S. PATENT DOCUMENTS**

D402,651 S \* 12/1998 Depay et al. .... D14/372  
D533,893 S \* 12/2006 Canavan et al. .... D16/330  
D565,082 S \* 3/2008 McClure et al. .... D16/309  
D602,064 S \* 10/2009 Mitsui et al. .... D16/300  
D647,123 S \* 10/2011 Cho ..... D16/309  
D659,739 S \* 5/2012 Olsson et al. .... D16/300  
D659,740 S \* 5/2012 Olsson et al. .... D16/300

D660,341 S \* 5/2012 Olsson et al. .... D16/300  
D662,964 S \* 7/2012 Olsson et al. .... D16/300  
D664,184 S \* 7/2012 Olsson et al. .... D16/309  
D664,586 S \* 7/2012 Olsson ..... D16/300  
D665,008 S \* 8/2012 Olsson et al. .... D16/309  
D671,589 S \* 11/2012 Olsson ..... D16/300  
D688,727 S \* 8/2013 Olsson ..... D16/300  
D694,311 S \* 11/2013 Cho et al. .... D16/309  
D697,962 S \* 1/2014 Olsson ..... D16/300  
D701,506 S \* 3/2014 Pombo ..... D14/372  
D703,724 S \* 4/2014 Olsson ..... D16/300  
D708,181 S \* 7/2014 Olsson et al. .... D14/372  
D711,375 S \* 8/2014 Lee et al. .... D14/372  
D711,376 S \* 8/2014 Lee et al. .... D14/372  
D715,295 S \* 10/2014 Lee et al. .... D14/372  
D716,299 S \* 10/2014 Olsson et al. .... D14/372

\* cited by examiner

*Primary Examiner* — Austin Murphy

(74) *Attorney, Agent, or Firm* — Birch, Stewart, Kolasch & Birch, LLP

(57) **CLAIM**

The ornamental design for a head mounted display device, as shown and described.

**DESCRIPTION**

FIG. 1 is a perspective view of a head mounted display device showing our new design;  
FIG. 2 is a front view thereof;  
FIG. 3 is a rear view thereof;  
FIG. 4 is a left side view thereof;  
FIG. 5 is a right side view thereof;  
FIG. 6 is a top plan view thereof;  
FIG. 7 is a bottom plan view thereof; and,  
FIG. 8 is a reference view thereof showing the state that the user wears the subject design.

The broken lines show unclaimed subject matter only and form no part of the claimed design. The dash-dot broken lines define the bounds of the claimed design and form no part thereof.

**1 Claim, 6 Drawing Sheets**

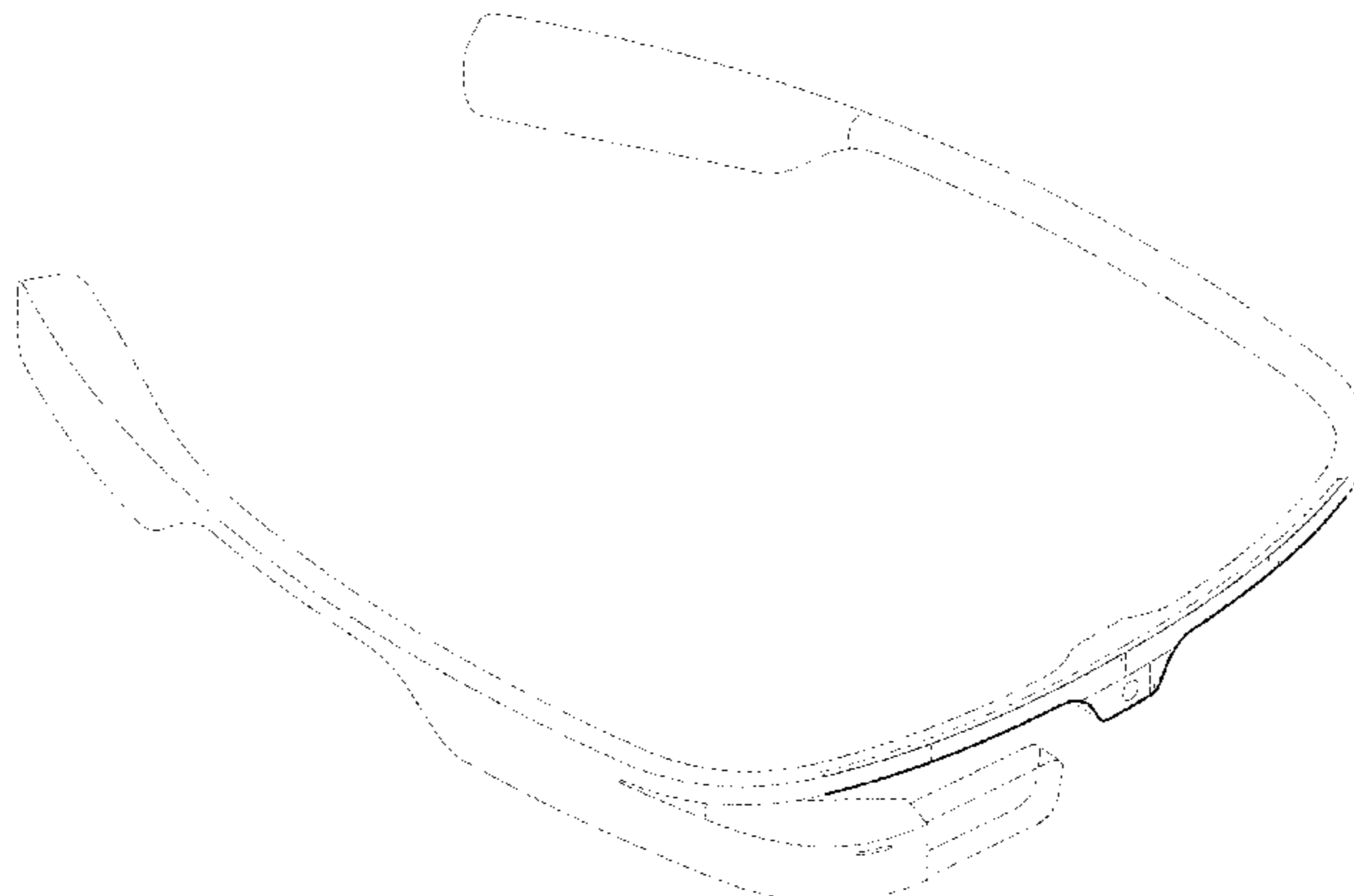

FIG. 1

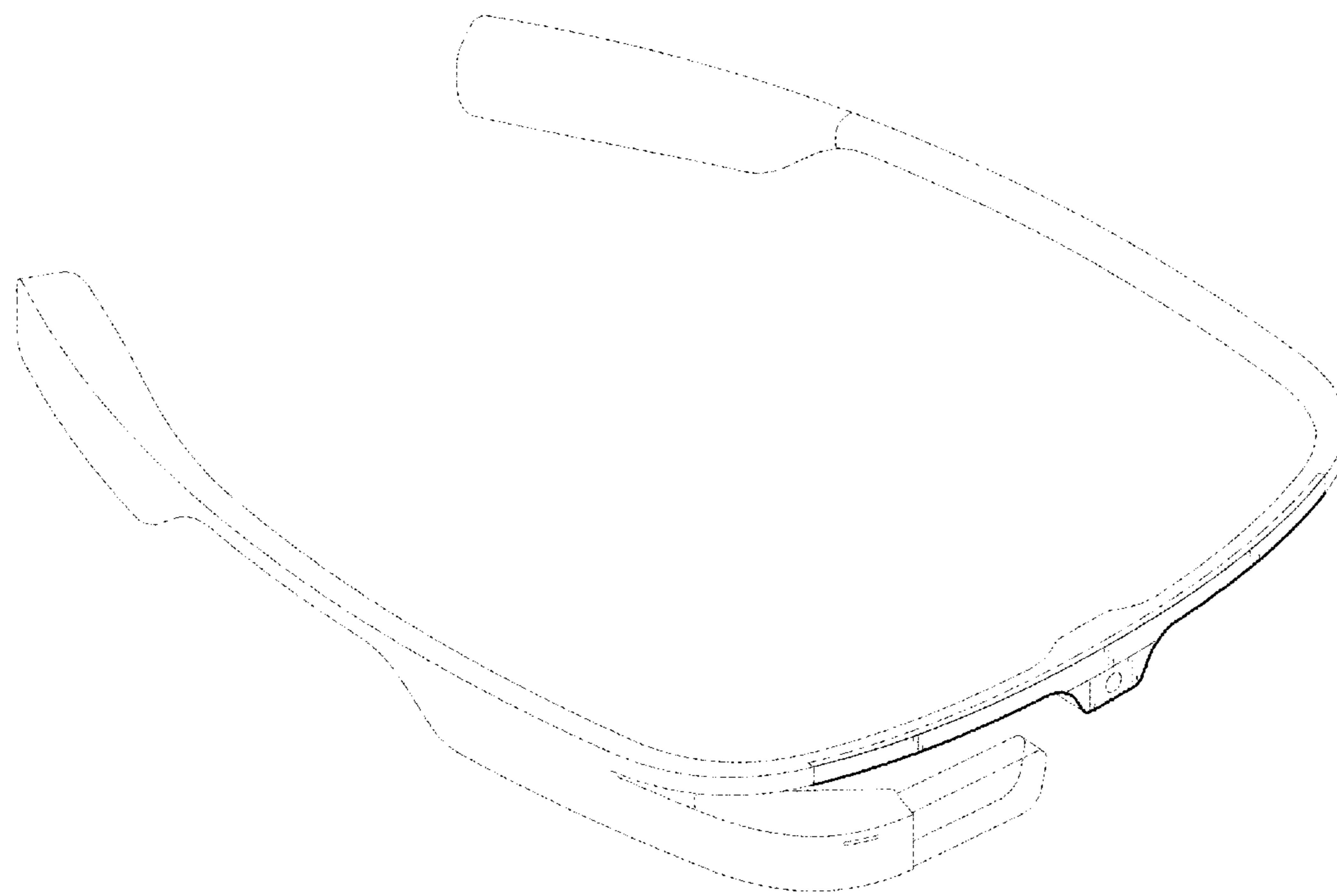

FIG. 2

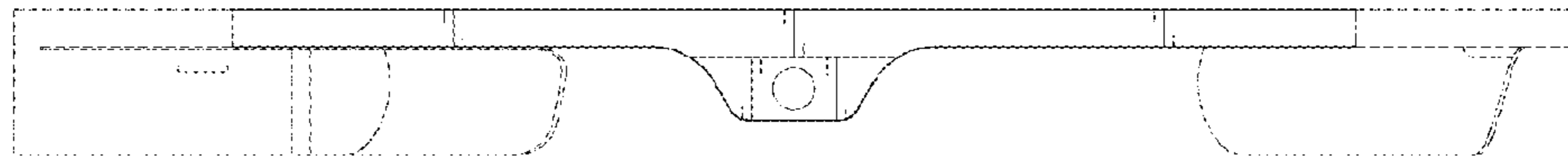

FIG. 3

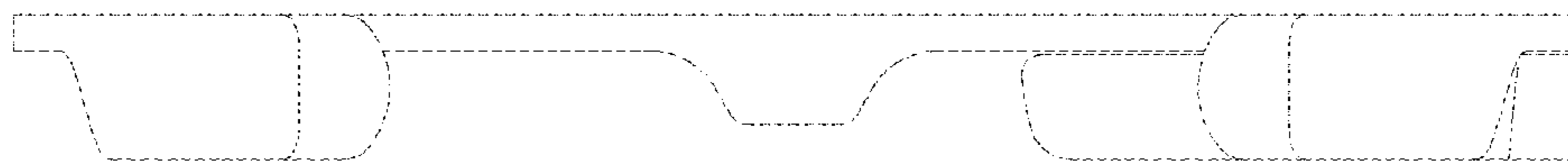

FIG. 4

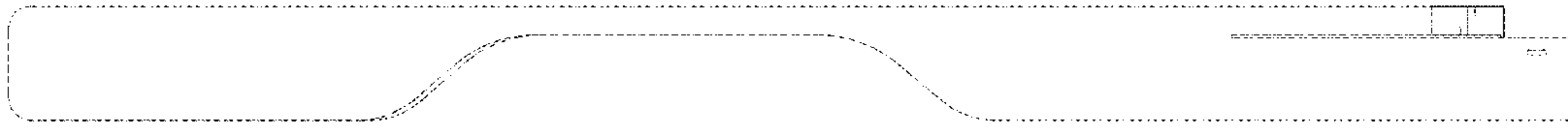

FIG. 5

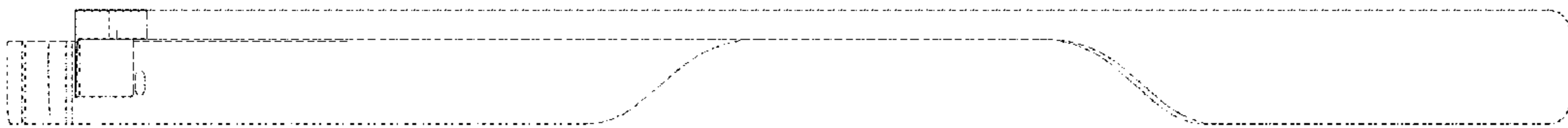

FIG. 6

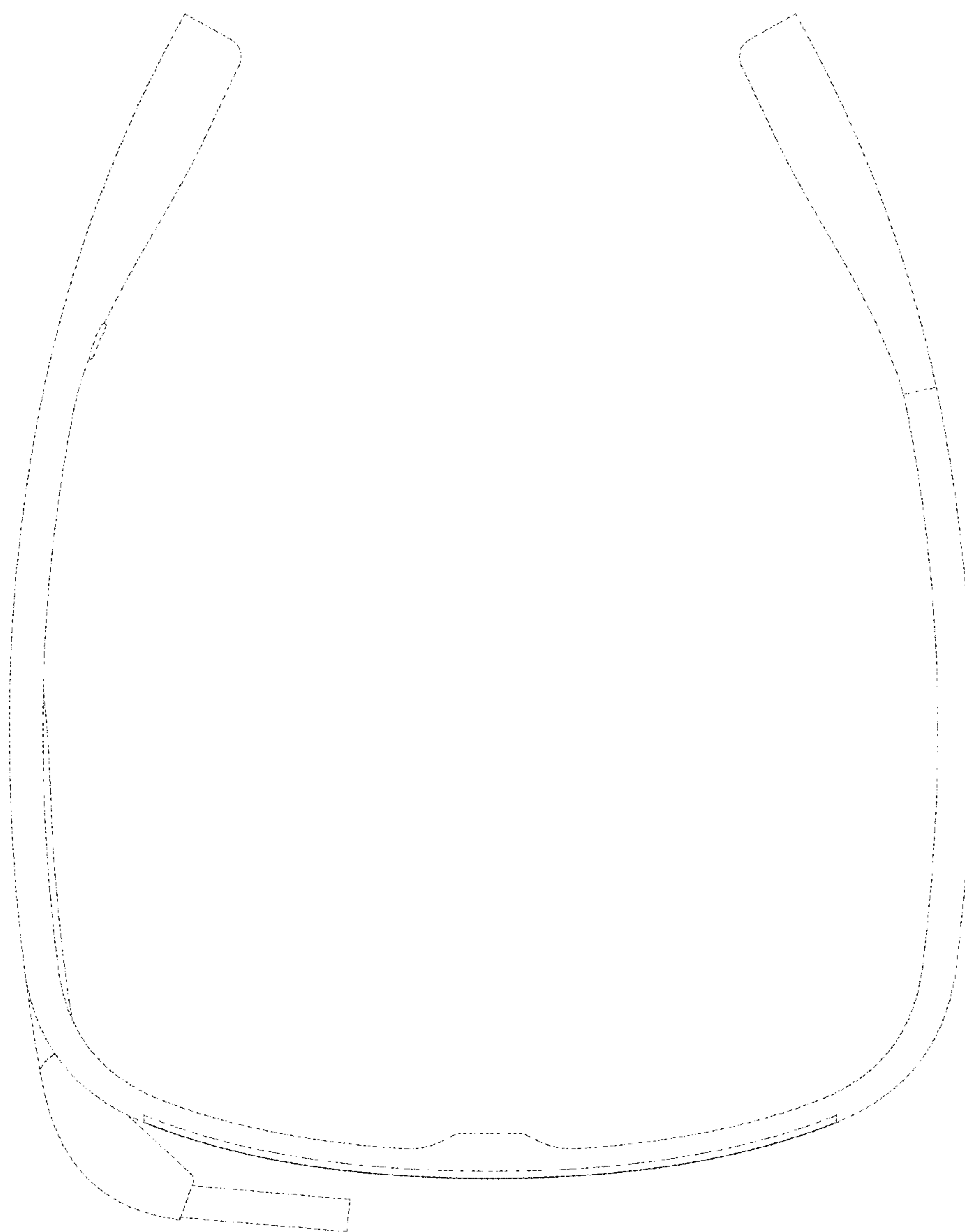

FIG. 7

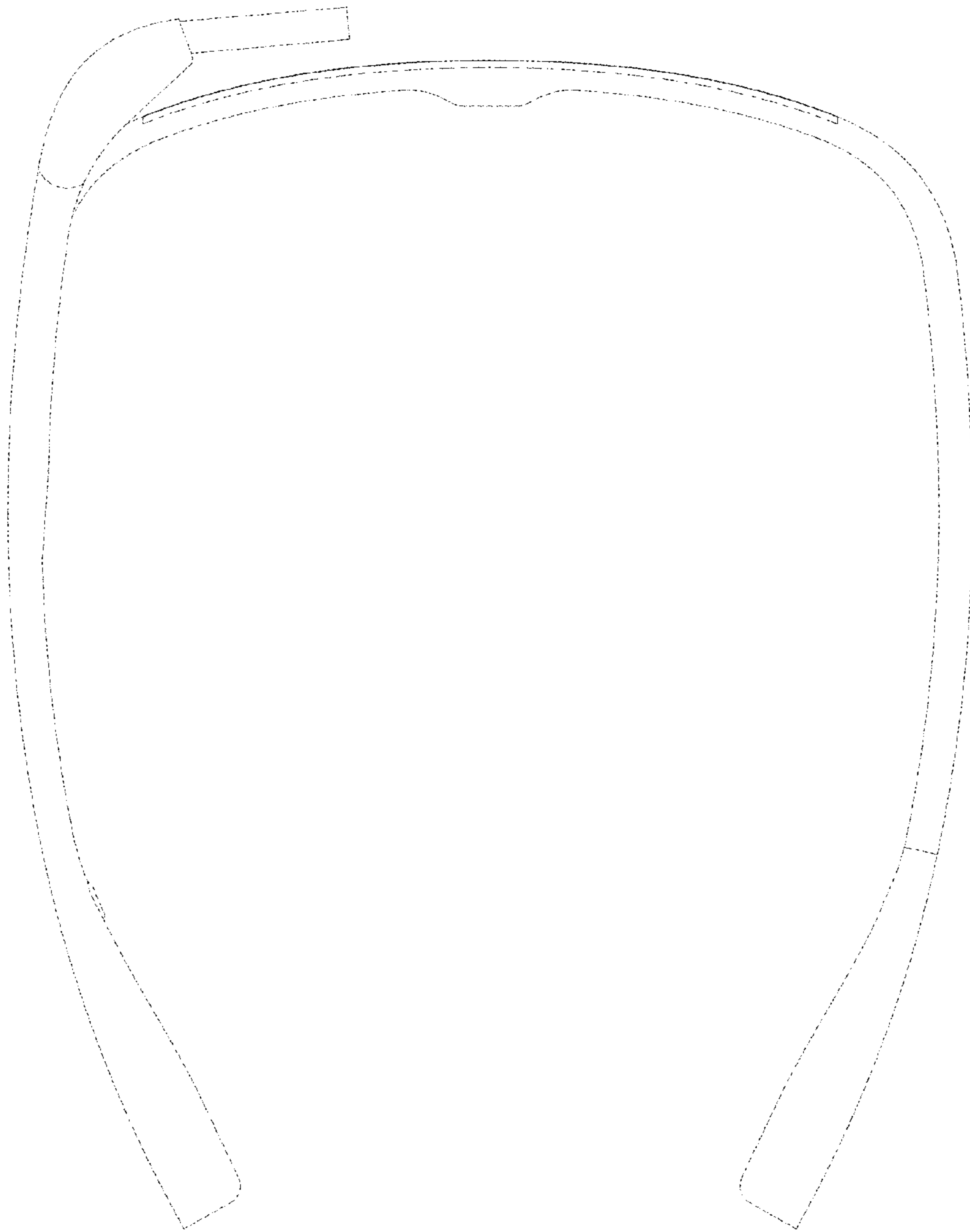

FIG. 8

