

US00D725638S

(12) **United States Design Patent**
Hofman et al.

(10) **Patent No.:** **US D725,638 S**
(45) **Date of Patent:** **** Mar. 31, 2015**

- (54) **DISPLAY SCREEN MOUNT**
- (71) Applicant: **Steelcase Inc.**, Grand Rapids, MI (US)
- (72) Inventors: **William Kirk Hofman**, Ada, MI (US);
Shawn Kerstan Littrell, Grand Rapids,
MI (US); **Karl Jahn Mead**, Grand
Rapids, MI (US)
- (73) Assignee: **Steelcase Inc.**, Grand Rapids, MI (US)
- (**) Term: **14 Years**
- (21) Appl. No.: **29/432,535**
- (22) Filed: **Sep. 17, 2012**
- (51) **LOC (10) Cl.** **14-03**
- (52) **U.S. Cl.**
USPC **D14/239**
- (58) **Field of Classification Search**
USPC D14/239, 168, 188, 197, 198, 371,
D14/374-377, 496-510; 312/7.1, 7.2;
348/836, 838, 180, 184, 325, 739, 825,
348/827; 341/12; 349/58; 720/600, 619,
720/646, 647, 655; 455/347-351;
369/75.11, 75.21; D6/474-499, 407,
D6/460, 461, 468; 248/465, 917-924,
248/123.11, 231.9, 282.1; 600/41.12, 42,
600/49.1, 50, 85.2, 90.04, 187, 190,
600/119.003, 134.153, 87.01, 71.01;
211/87.01; 52/27, 741.1, 220.1, 220.7;
174/63, 64, 61, 58; 361/679.02,
361/679.01, 679.05, 379.06
See application file for complete search history.

5,870,867	A	2/1999	Mitchell	
5,918,431	A	7/1999	Schiedegger et al.	
6,158,179	A	12/2000	Ackerly et al.	
6,370,037	B1 *	4/2002	Schoenfish	361/807
6,480,243	B2	11/2002	Yamamoto	
6,588,159	B1 *	7/2003	Cotton, Jr.	52/211
6,802,575	B1 *	10/2004	Lee	312/7.2
6,851,226	B2	2/2005	MacGregor et al.	
6,966,617	B2	11/2005	Chen et al.	
D520,355	S	5/2006	Overthun et al.	

(Continued)

Primary Examiner — Randall Gholson
(74) *Attorney, Agent, or Firm* — Price Heneveld LLP

(57) **CLAIM**
The ornamental design for display screen mount, as shown and described.

DESCRIPTION

FIG. 1 is an isometric view of a display screen mount, showing our new design;
 FIG. 2 is an isometric view thereof;
 FIG. 3 is a front elevational view thereof;
 FIG. 4 is a rear elevational view thereof;
 FIG. 5 is a left side view thereof;
 FIG. 6 is right side view thereof;
 FIG. 7 is a top plan view thereof; and
 FIG. 8 is a bottom plan view thereof.
 FIG. 9 is an isometric view of a display screen mount, according to another aspect of our new design;
 FIG. 10 is an isometric view thereof;
 FIG. 11 is a front elevational view thereof;
 FIG. 12 is a rear elevational view thereof;
 FIG. 13 is a left side view thereof;
 FIG. 14 is right side view thereof;
 FIG. 15 is a top plan view thereof; and,
 FIG. 16 is a bottom plan view thereof.
 The dashed lines in the figures show the environment of the present design and are not part of the present design.
 The broken away symbols in the drawings indicate that any portion of the display screen mount beyond what is shown forms no part of the claimed design.

1 Claim, 8 Drawing Sheets

- (56) **References Cited**
U.S. PATENT DOCUMENTS
- 5,038,539 A 8/1991 Kelley et al.
- 5,207,041 A 5/1993 Wills
- 5,277,005 A 1/1994 Hellwig et al.
- 5,321,579 A 6/1994 Brown et al.
- 5,708,528 A 1/1998 Furuya
- 5,778,612 A 7/1998 Kissinger et al.
- 5,826,385 A 10/1998 Dykstra et al.

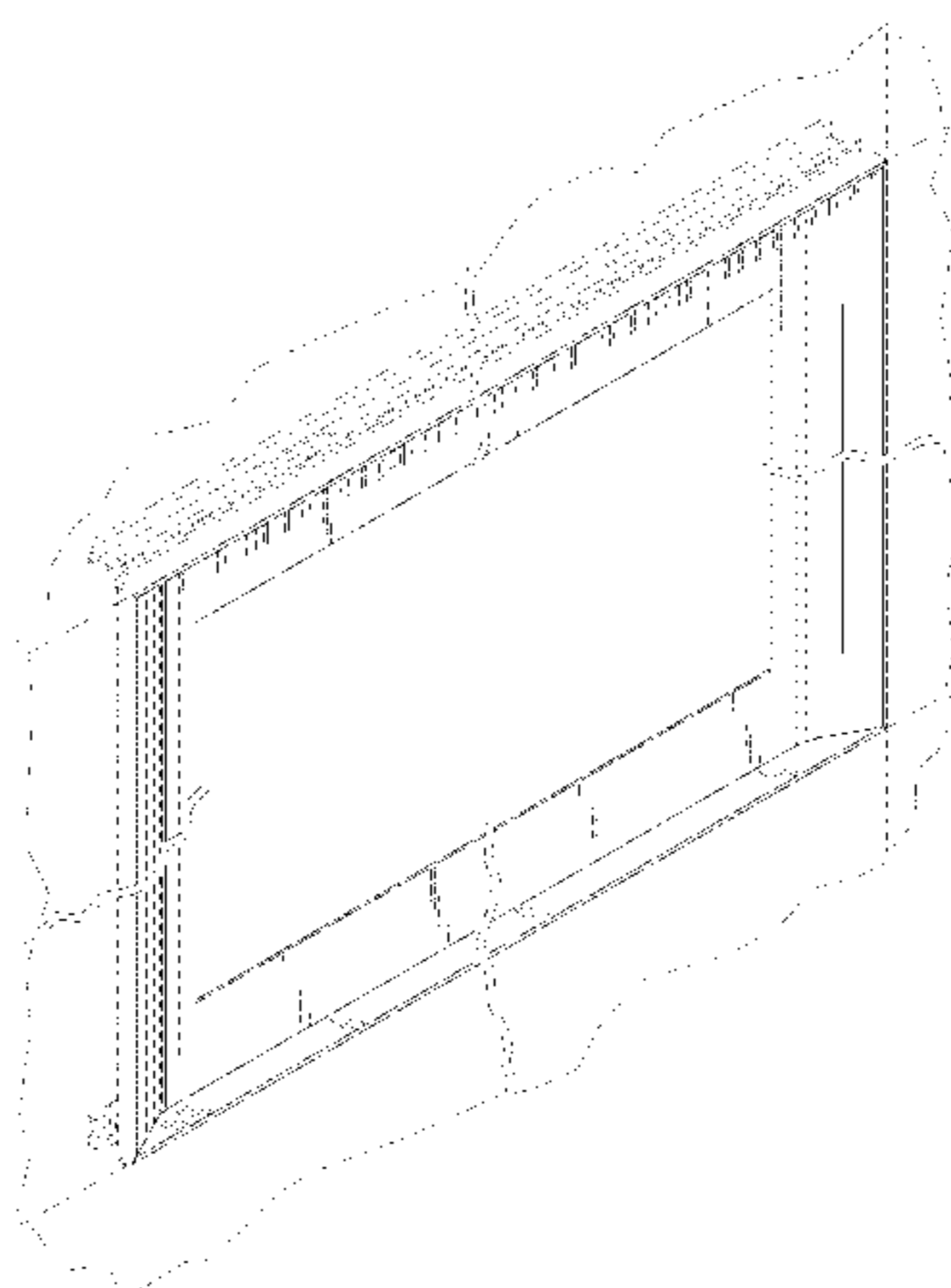

(56)

References Cited

U.S. PATENT DOCUMENTS

7,453,686 B2 11/2008 Elberbaum
 7,461,483 B2 12/2008 Struthers et al.
 7,461,484 B2 12/2008 Battey et al.
 7,463,490 B2* 12/2008 Kim et al. 361/752
 7,609,531 B2 10/2009 Xia et al.
 7,866,622 B2 1/2011 Dittmer
 7,868,951 B2 1/2011 Maruta et al.
 7,908,805 B2 3/2011 Metcalf et al.
 7,926,770 B2* 4/2011 Bonshor 248/205.1
 7,975,976 B2* 7/2011 Wohlford 248/282.1
 8,024,901 B2 9/2011 Gosling et al.

D650,784 S * 12/2011 Feldstein et al. D14/434
 D654,502 S * 2/2012 Walker D14/450
 D669,075 S * 10/2012 Seo D14/371
 8,276,862 B2* 10/2012 Eshita et al. 248/274.1
 8,593,578 B1* 11/2013 Geronimi 348/739
 8,714,665 B2* 5/2014 Campagna et al. 312/7.2
 D713,828 S * 9/2014 Stifal D14/239
 2006/0185276 A1 8/2006 Pai
 2006/0186277 A1 8/2006 Miyashiro
 2006/0214072 A1 9/2006 Lee
 2007/0096606 A1 5/2007 Ryu
 2008/0024686 A1 1/2008 Vafiadis
 2008/0218952 A1 9/2008 Benn
 2010/0095604 A1 4/2010 Newkirk et al.

* cited by examiner

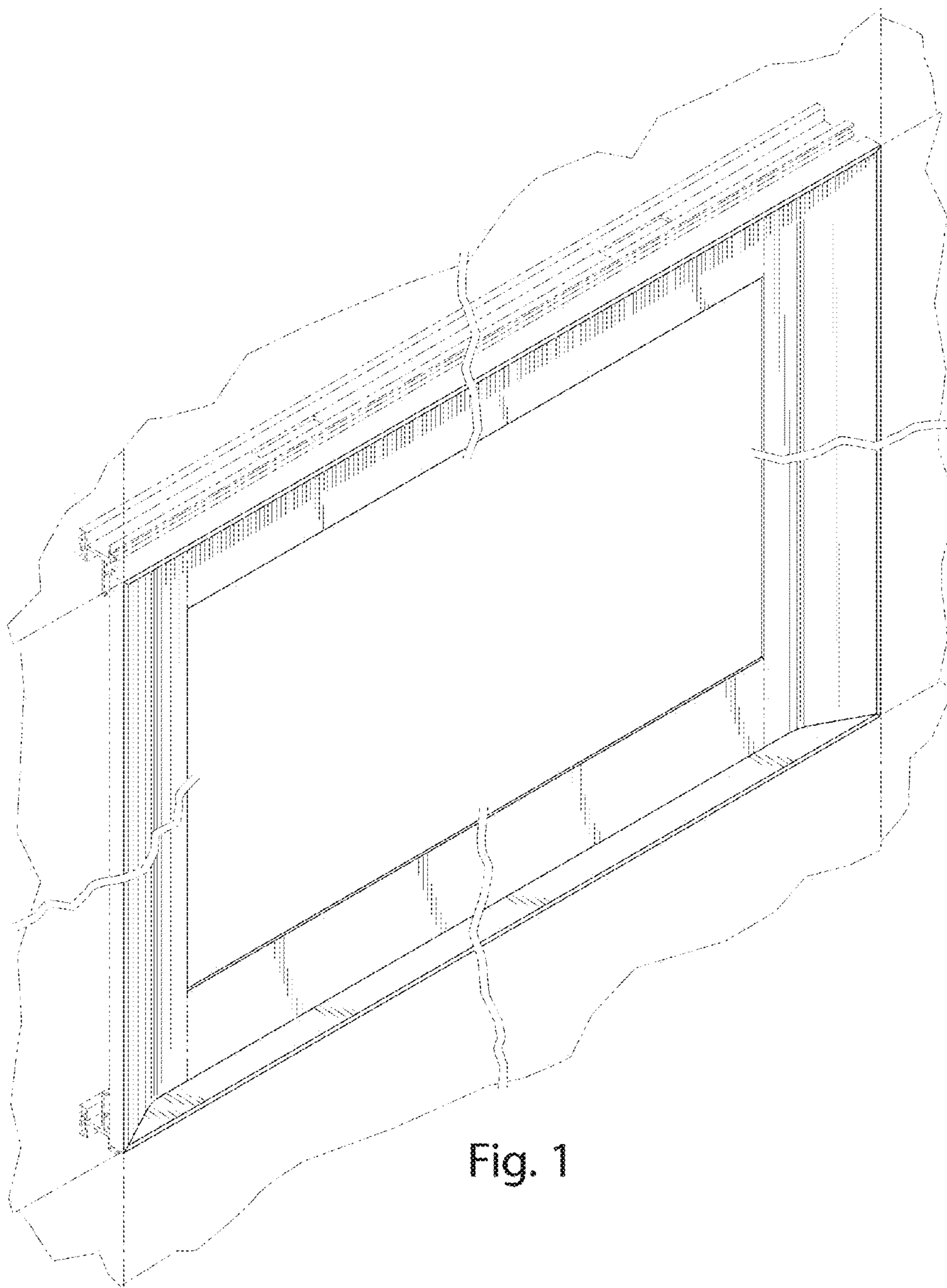

Fig. 1

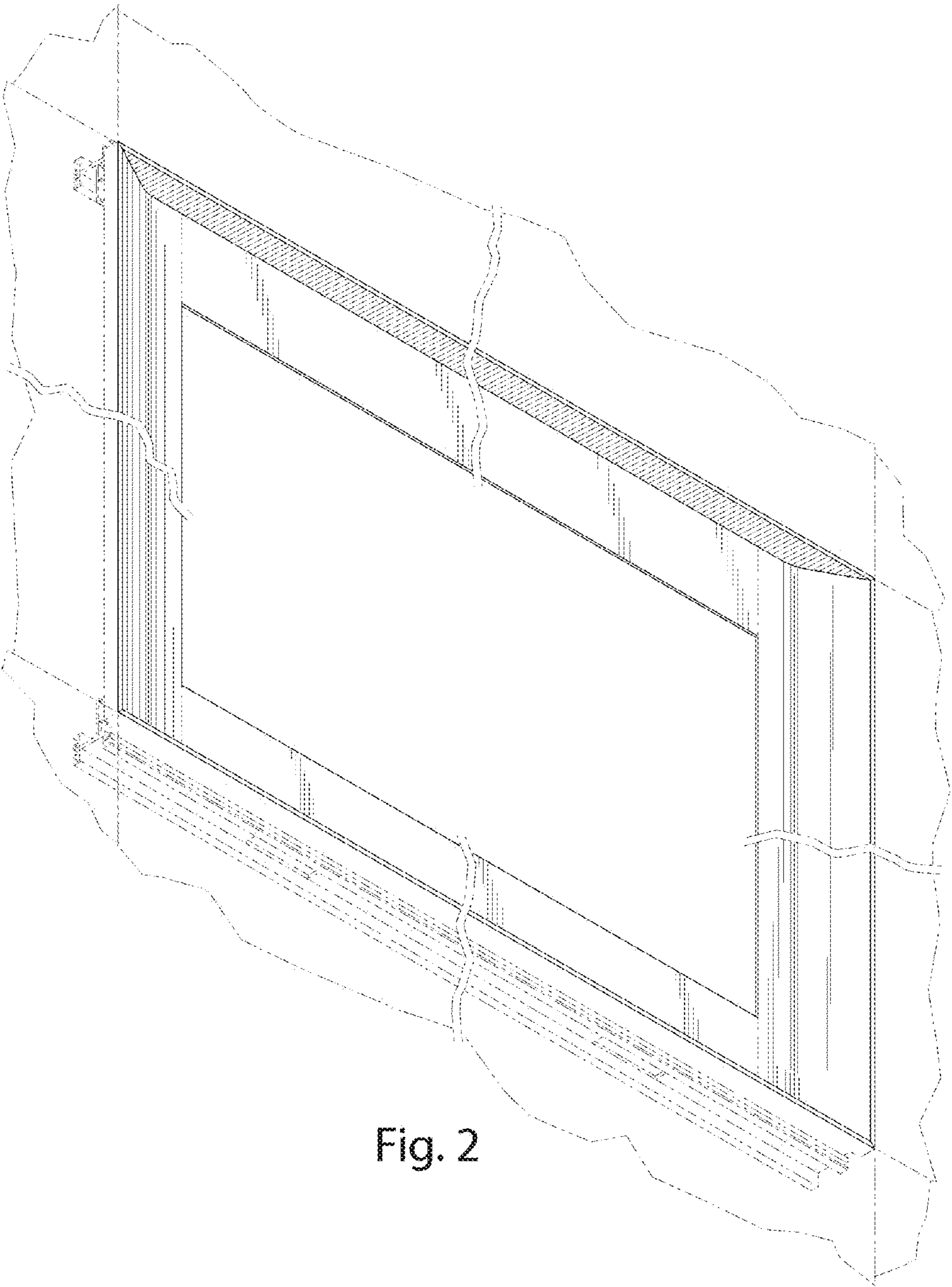

Fig. 2

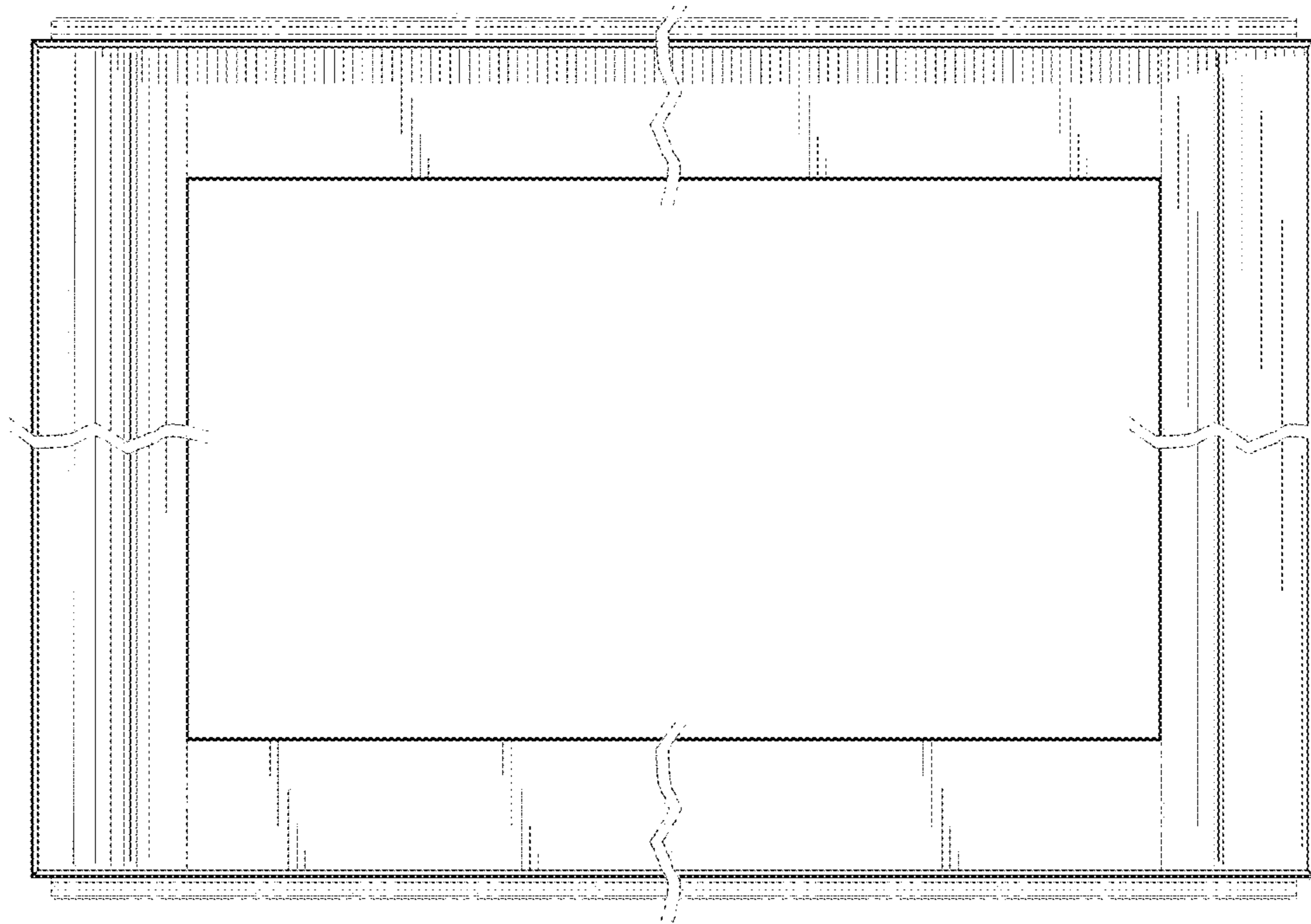

Fig. 3

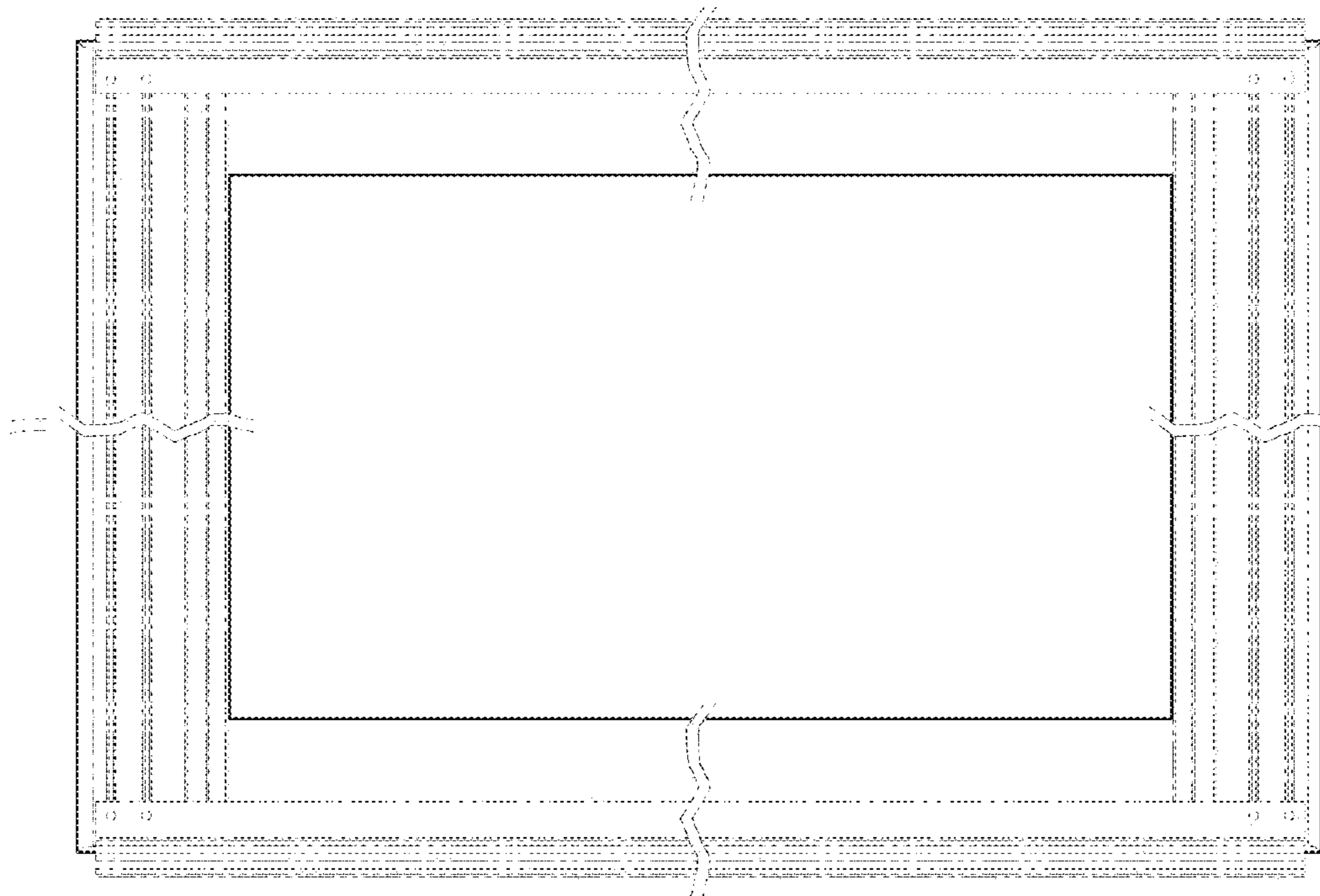

Fig. 4

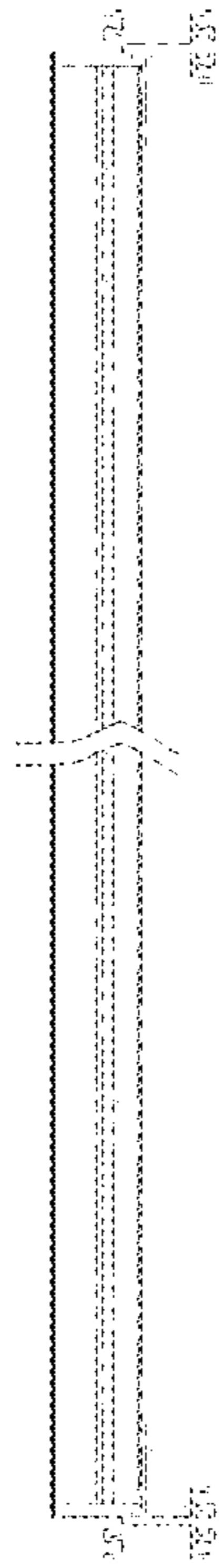

Fig. 5

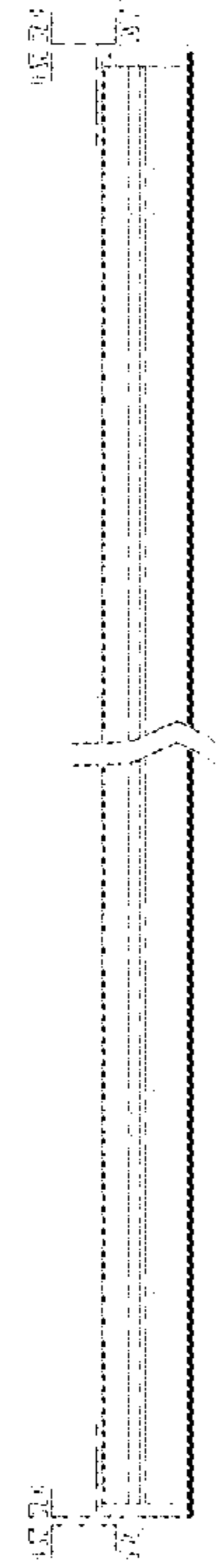

Fig. 6

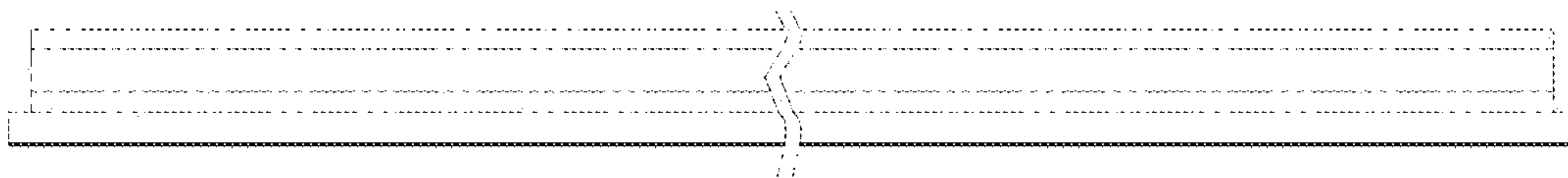

Fig. 7

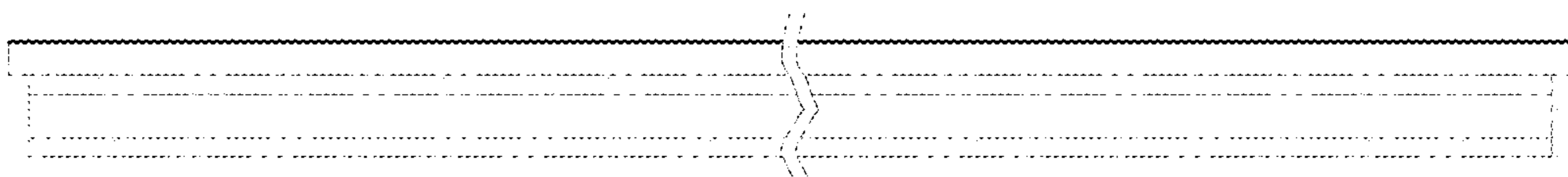

Fig. 8

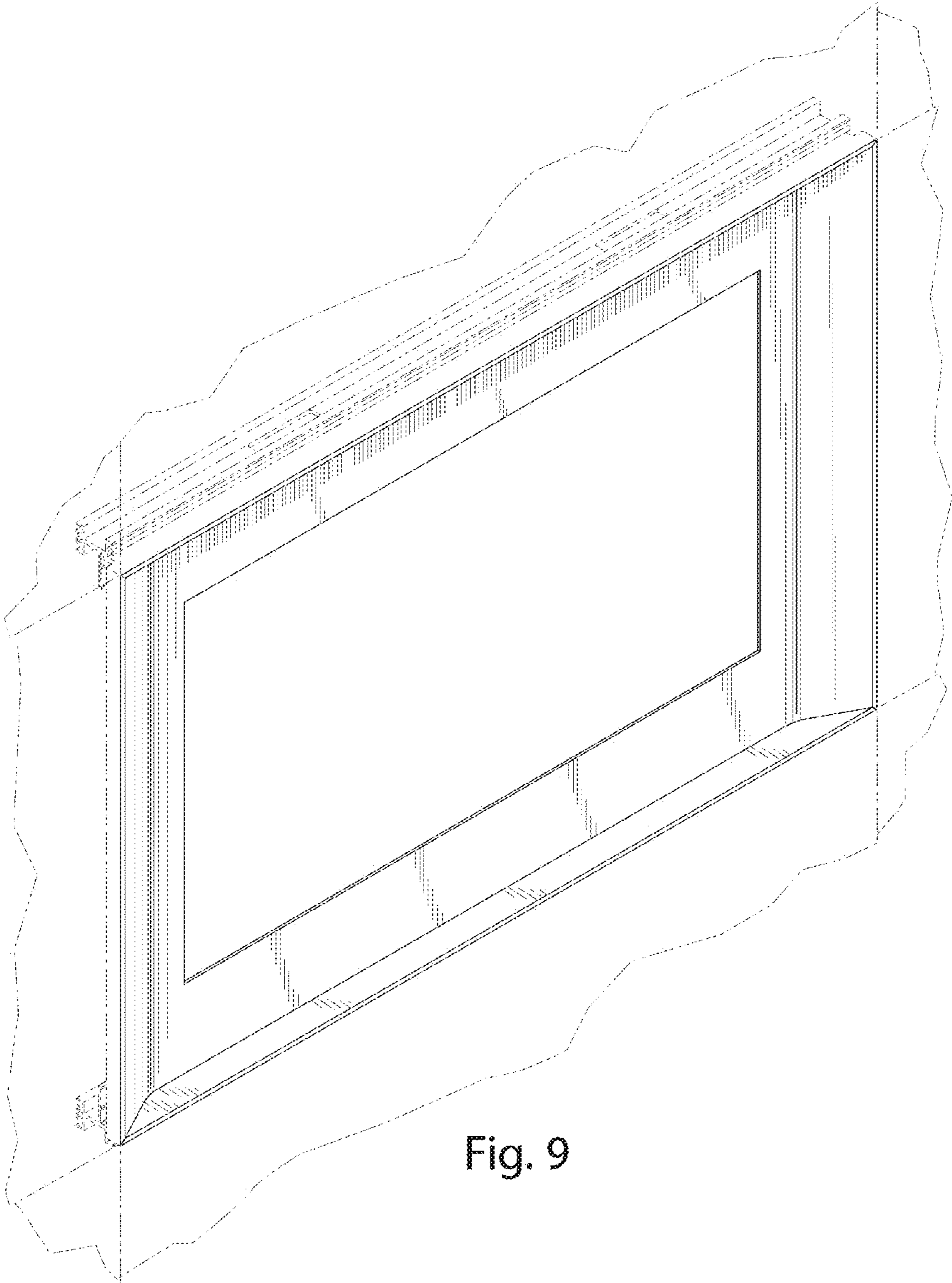

Fig. 9

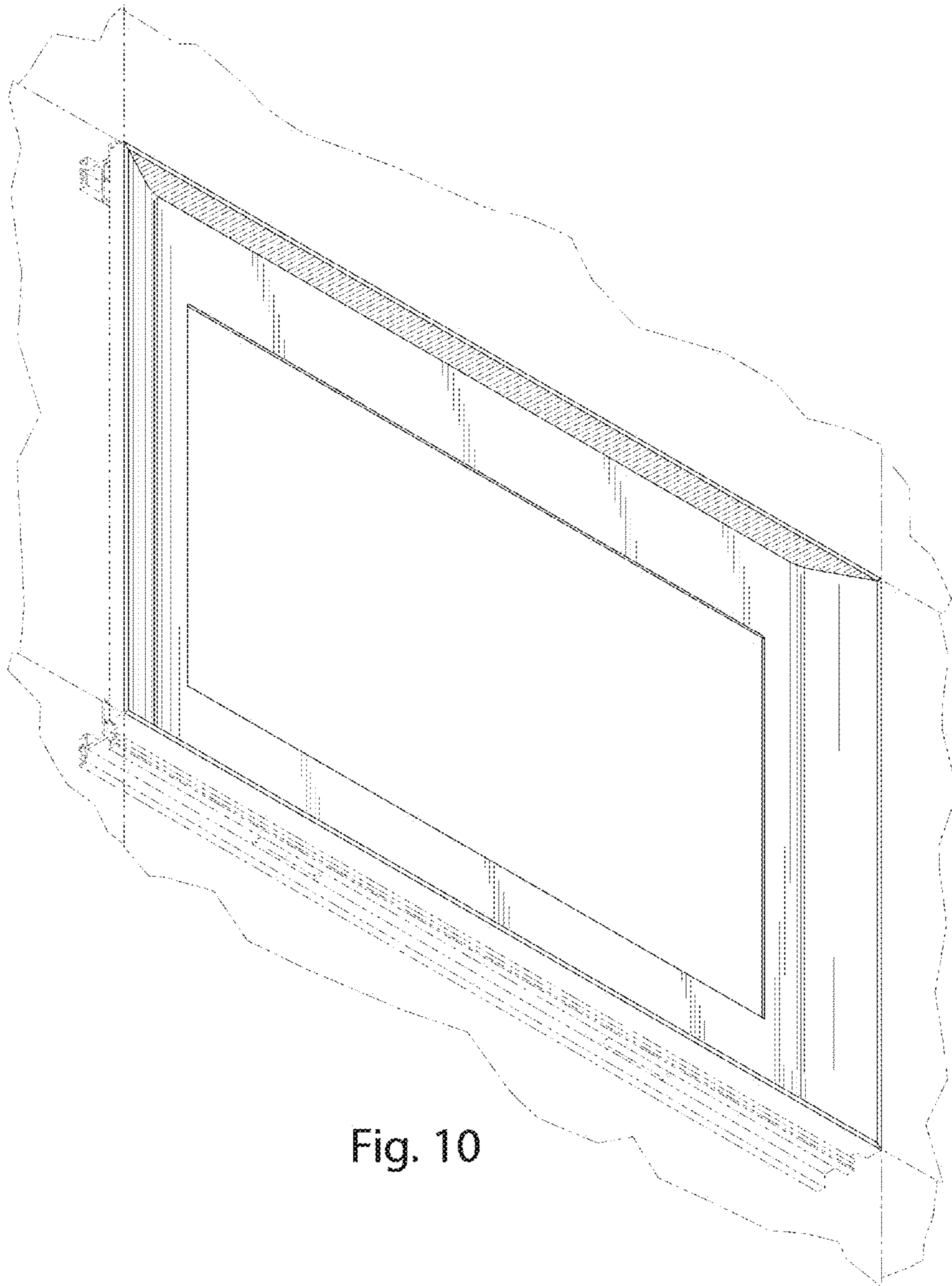

Fig. 10

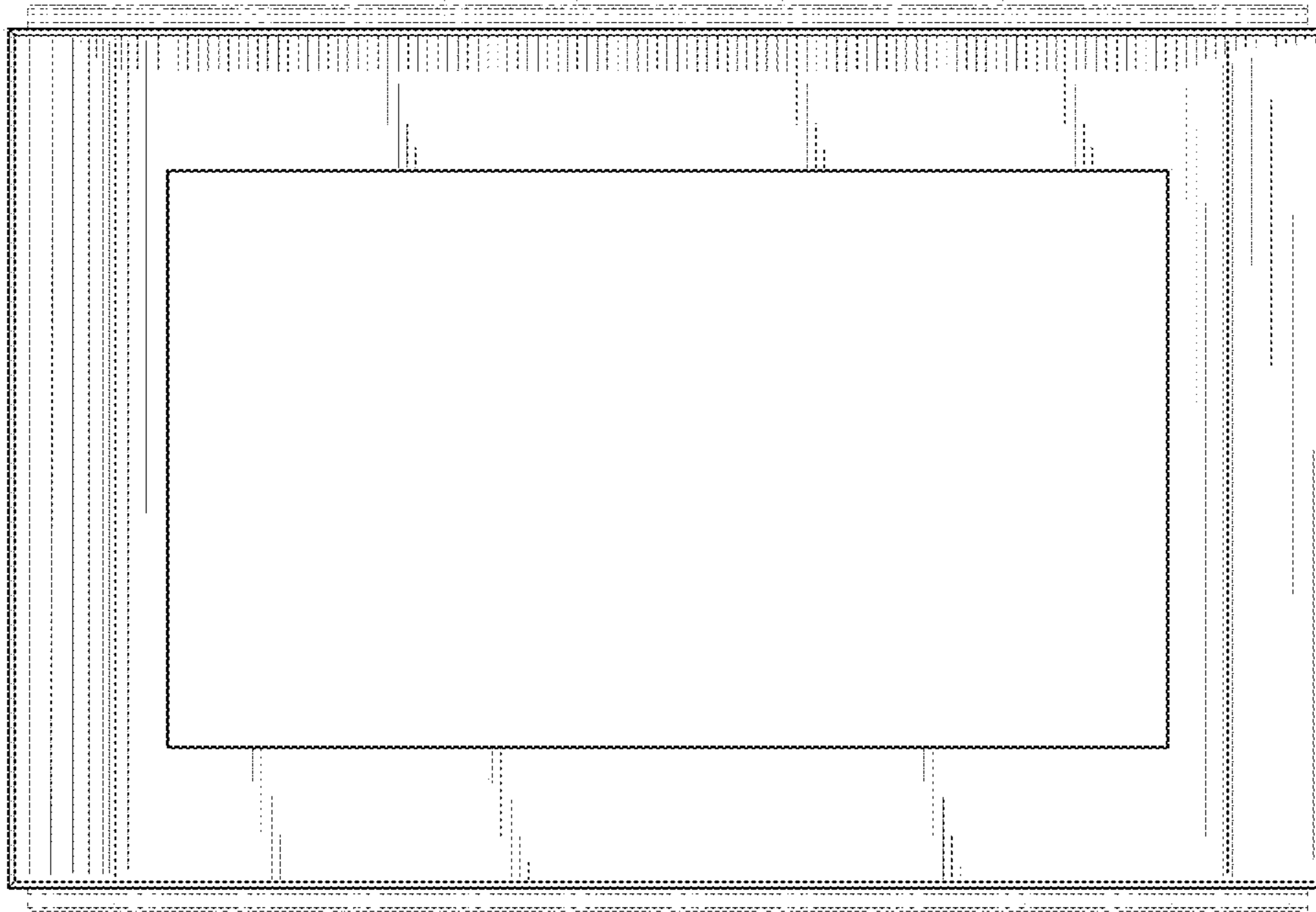

Fig. 11

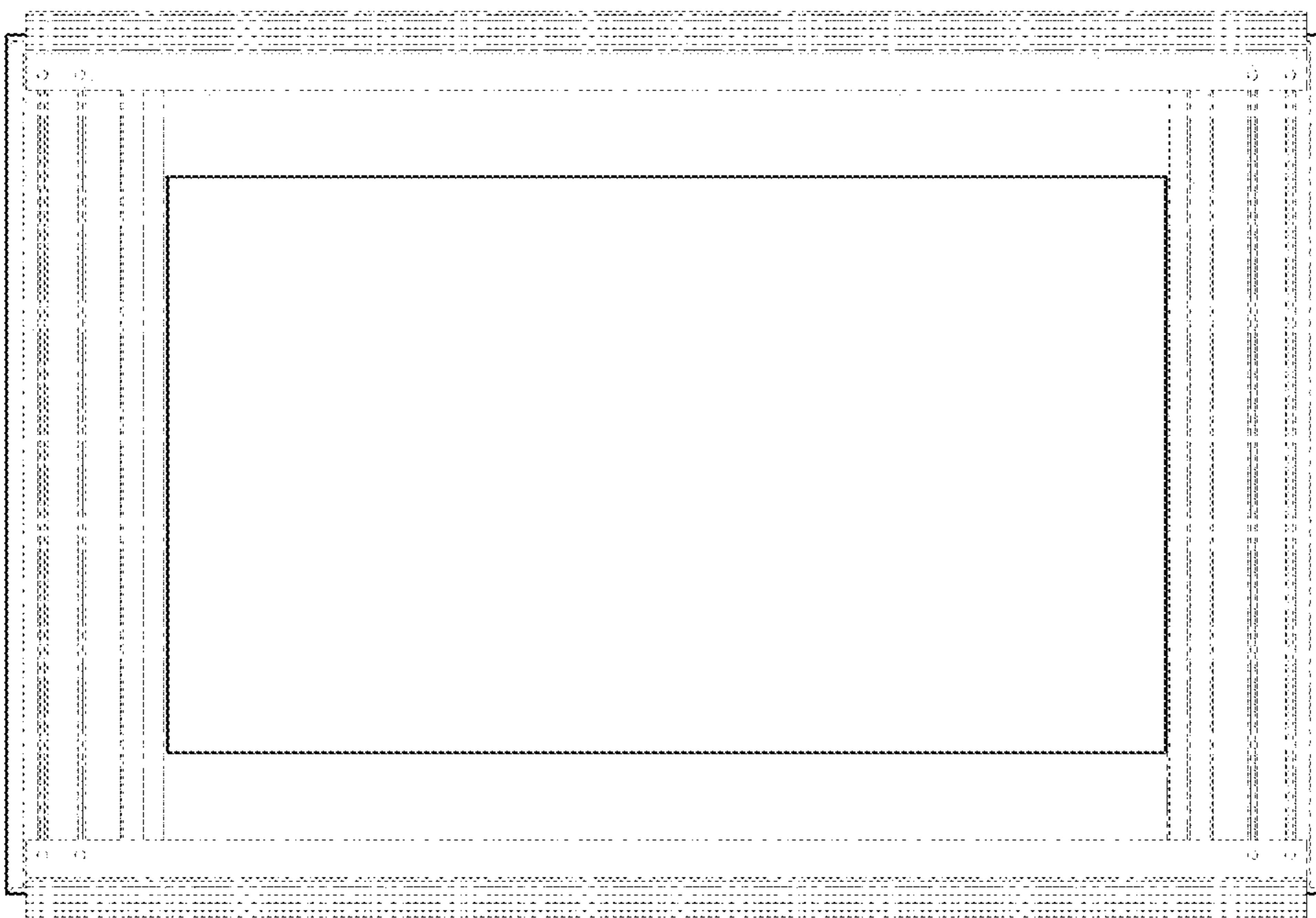

Fig. 12

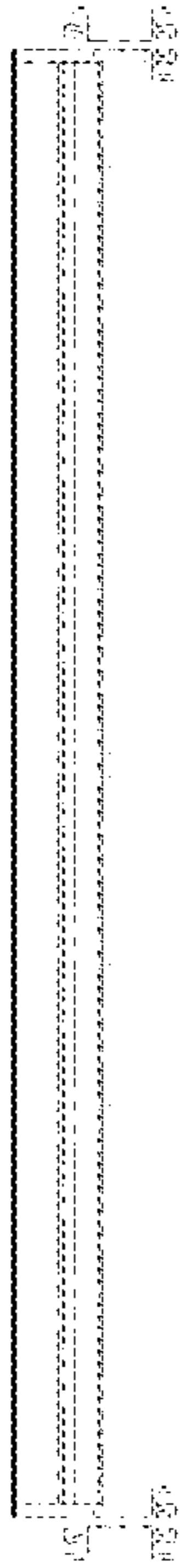

Fig. 13

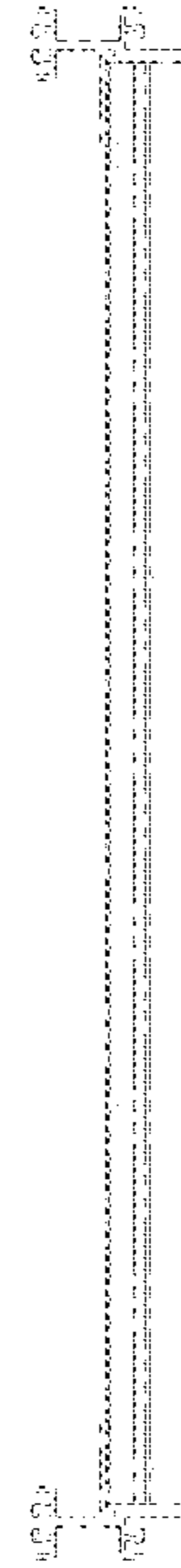

Fig. 14

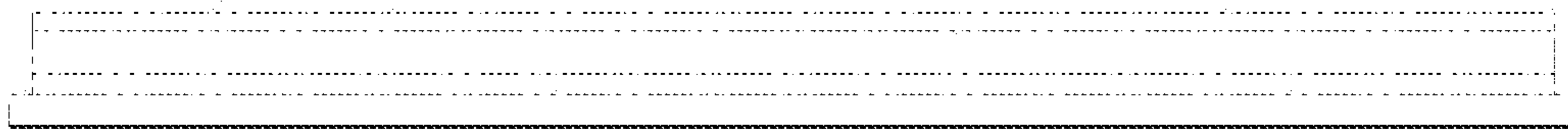

Fig. 15

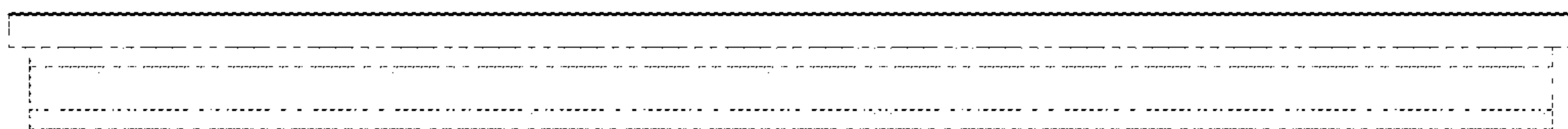

Fig. 16