



US00D725527S

(12) **United States Design Patent**  
**Parmigiani**

(10) **Patent No.:** **US D725,527 S**  
(45) **Date of Patent:** **\*\* Mar. 31, 2015**

(54) **LUG FOR A WATCH**  
(71) Applicant: **Michel Parmigiani**, Fleurier (CH)  
(72) Inventor: **Michel Parmigiani**, Fleurier (CH)  
(73) Assignee: **Parmigiani Fleurier SA** (CH)  
(\*\*) Term: **14 Years**  
(21) Appl. No.: **29/484,677**

D590,727 S \* 4/2009 Wei ..... D10/38  
D592,975 S \* 5/2009 Markl ..... D10/32  
D611,844 S \* 3/2010 Furetta ..... D10/39  
D618,119 S \* 6/2010 Tonohori ..... D10/38  
D637,920 S \* 5/2011 Parmigiani ..... D10/38  
D645,361 S \* 9/2011 Parmigiani ..... D10/38  
D655,630 S \* 3/2012 Behling ..... D10/38

(Continued)

*Primary Examiner* — Lucy Lieberman  
(74) *Attorney, Agent, or Firm* — Galbreath Law Offices,  
P.C.; John A. Galbreath

(30) **Foreign Application Priority Data**

Sep. 13, 2013 (WO) ..... DM/081750

(51) **LOC (10) Cl.** ..... **10-07**

(52) **U.S. Cl.**  
USPC ..... **D10/128**

(58) **Field of Classification Search**  
CPC .. G04B 37/00; G04B 37/008; G04B 37/0058;  
G04B 45/0069; G04B 37/081; G04B 37/106;  
G04G 21/08  
USPC ..... D10/30-39, 128; 368/276, 281, 282,  
368/290, 319, 320, 321, 316  
See application file for complete search history.

(56) **References Cited**

U.S. PATENT DOCUMENTS

D172,442 S \* 6/1954 Richter ..... D10/39  
D221,789 S \* 9/1971 Kolbrener ..... D10/39  
3,740,944 A \* 6/1973 Chopard ..... 368/281  
D474,118 S \* 5/2003 Monachon ..... D10/32  
D536,628 S \* 2/2007 Roth ..... D10/38  
D536,994 S \* 2/2007 Sugisawa et al. .... D10/31  
D536,998 S \* 2/2007 Fujihara ..... D10/38  
D538,181 S \* 3/2007 Sugiura ..... D10/31  
D545,222 S \* 6/2007 Parmigiani ..... D10/38  
D555,015 S \* 11/2007 Parmigiani ..... D10/38  
D570,230 S \* 6/2008 Monachon ..... D10/32  
D585,309 S \* 1/2009 Monachon ..... D10/39  
D588,941 S \* 3/2009 Fasciano ..... D10/38

(57) **CLAIM**  
The ornamental design for a lug for a watch, as shown and described.

**DESCRIPTION**

FIG. 1 is a top view of the invention;  
FIG. 2 is a bottom view of the invention;  
FIG. 3 is a side view of the invention;  
FIG. 4 is a back view of the invention;  
FIG. 5 is another side view of the invention, showing the side opposite that shown in FIG. 3;  
FIG. 6 is a front view of the invention;  
FIG. 7 is a perspective view of the invention;  
FIG. 8 is another perspective view of the invention;  
FIG. 9 is a top view of the invention mounted on a watch case;  
FIG. 10 is a bottom view of the invention mounted on a watch case;  
FIG. 11 is a side view of the invention mounted on a watch case;  
FIG. 12 is a front view of the invention mounted on a watch case;  
FIG. 13 is a perspective view of the invention mounted on a watch case; and,  
FIG. 14 is another perspective view of the invention mounted on a watch case.  
The watch case and other lugs that are shown in broken lines in FIGS. 9-14 are for illustrative purposes only and do not form part of the claimed design.

**1 Claim, 10 Drawing Sheets**

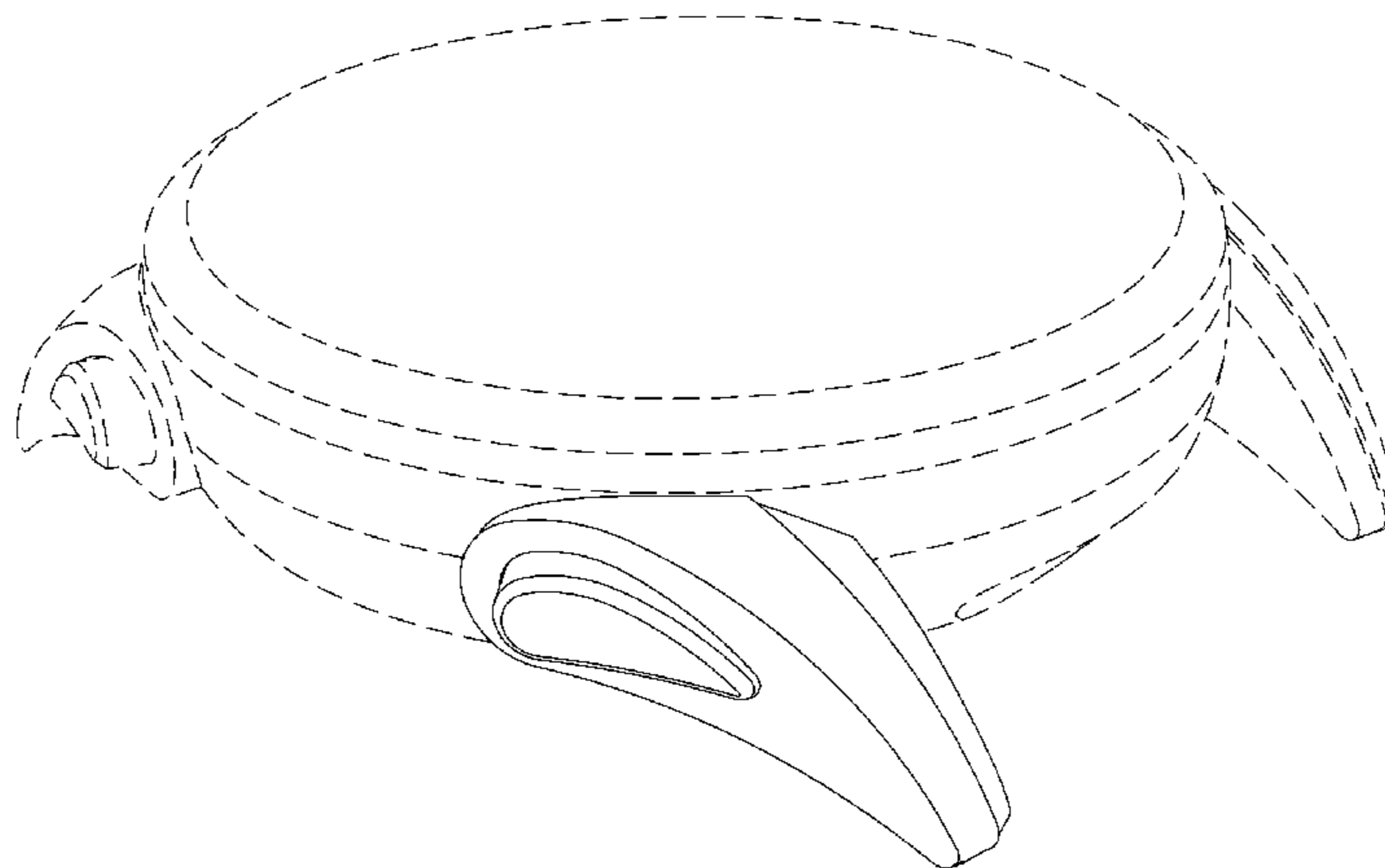

# US D725,527 S

Page 2

---

(56)

## References Cited

### U.S. PATENT DOCUMENTS

D671,429 S *	11/2012	Parmigiani .....	D10/38
D702,136 S *	4/2014	Monachon .....	D10/39
D711,750 S *	8/2014	Monachon .....	D10/39
D668,162 S *	10/2012	Inoue .....	D10/39

\* cited by examiner

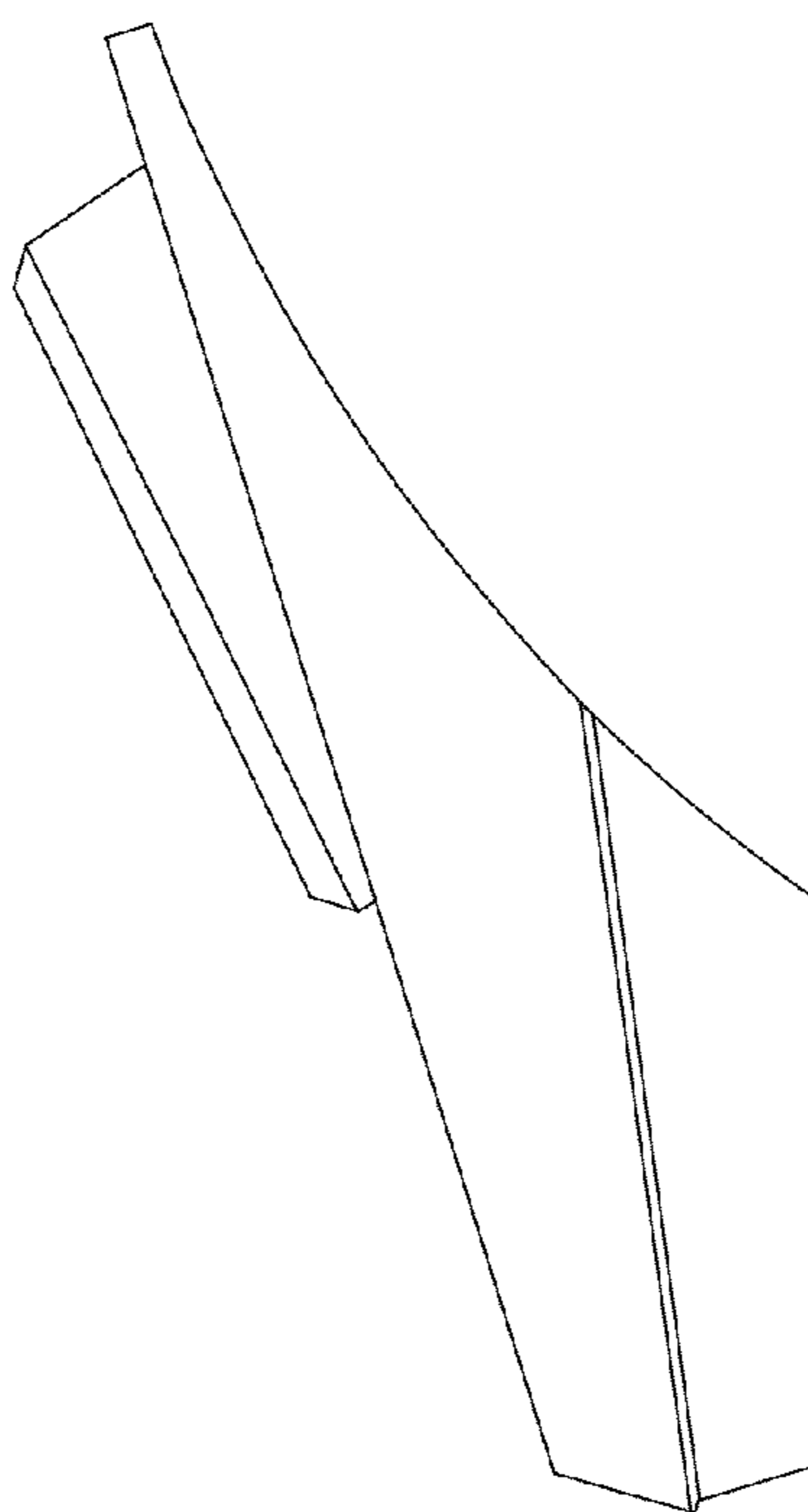

Fig. 1

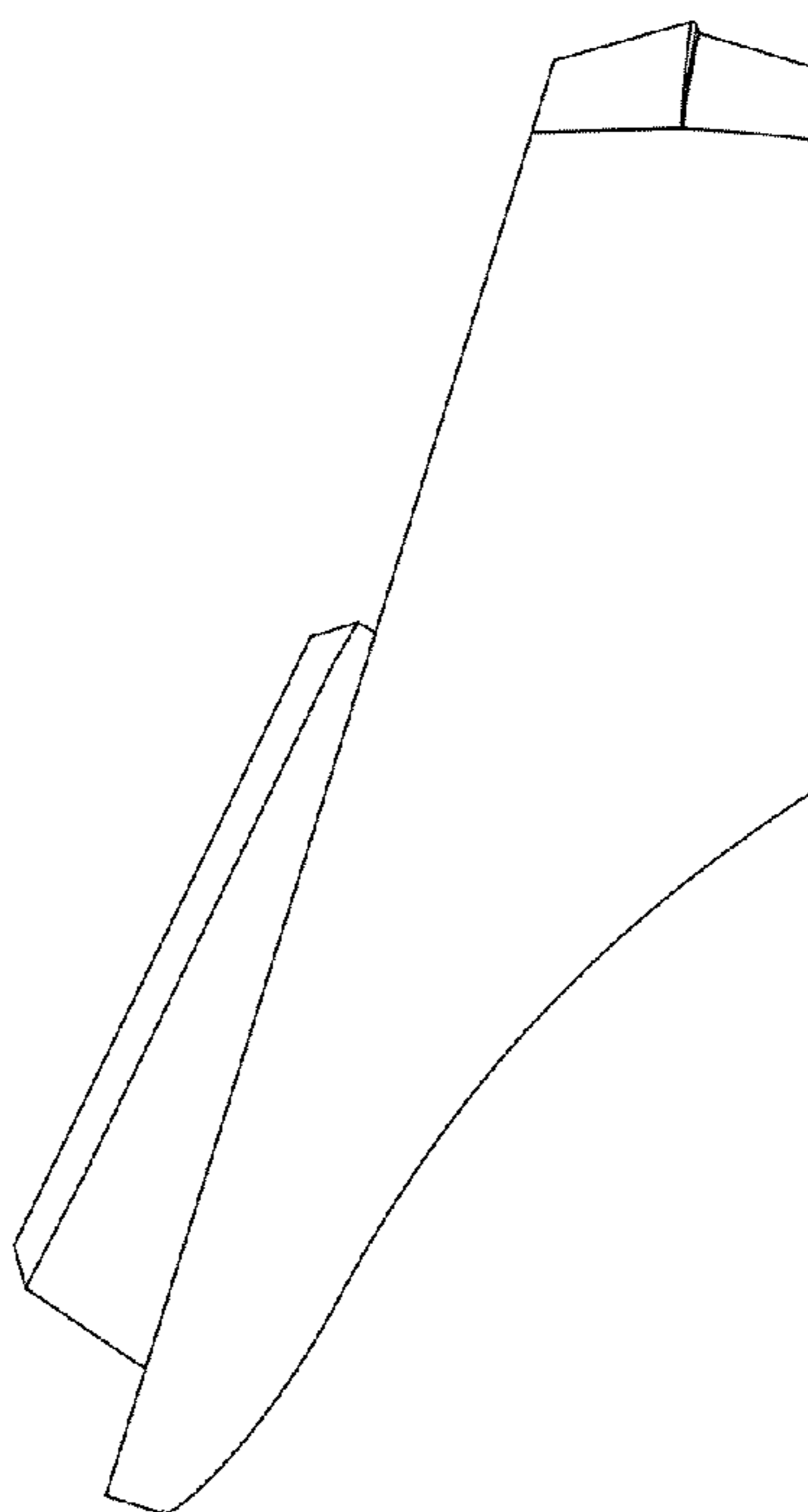

Fig. 2

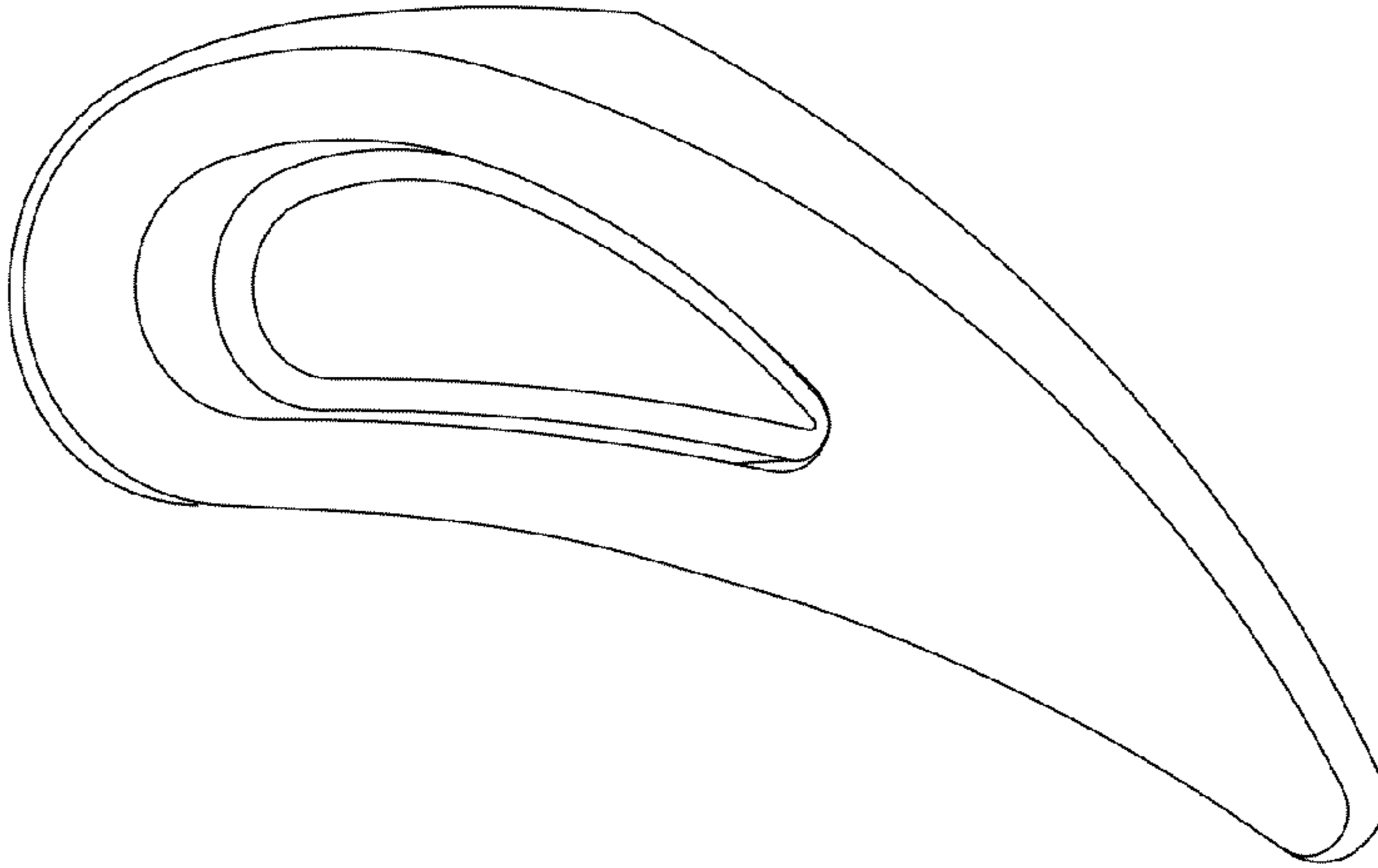

Fig. 3

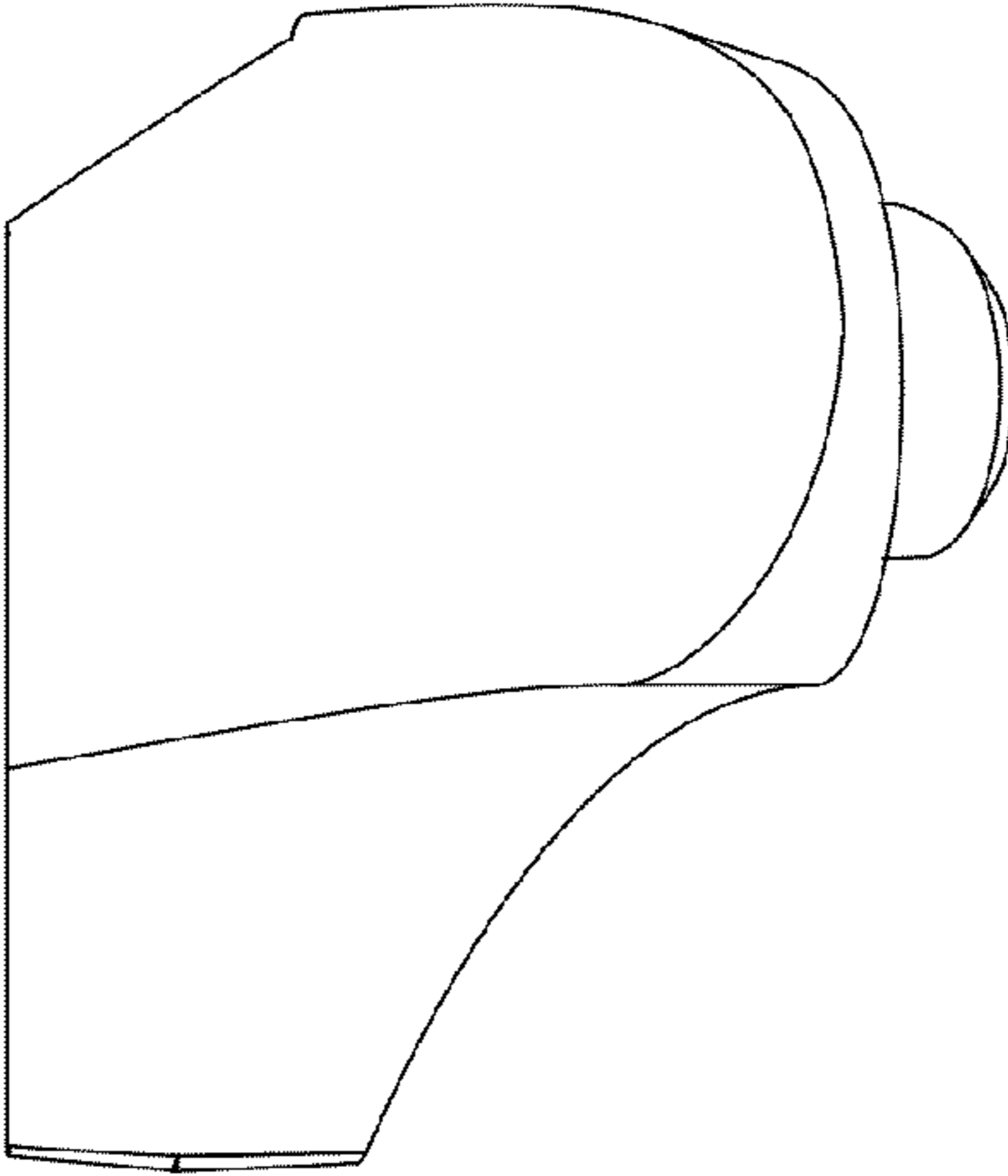

Fig. 4

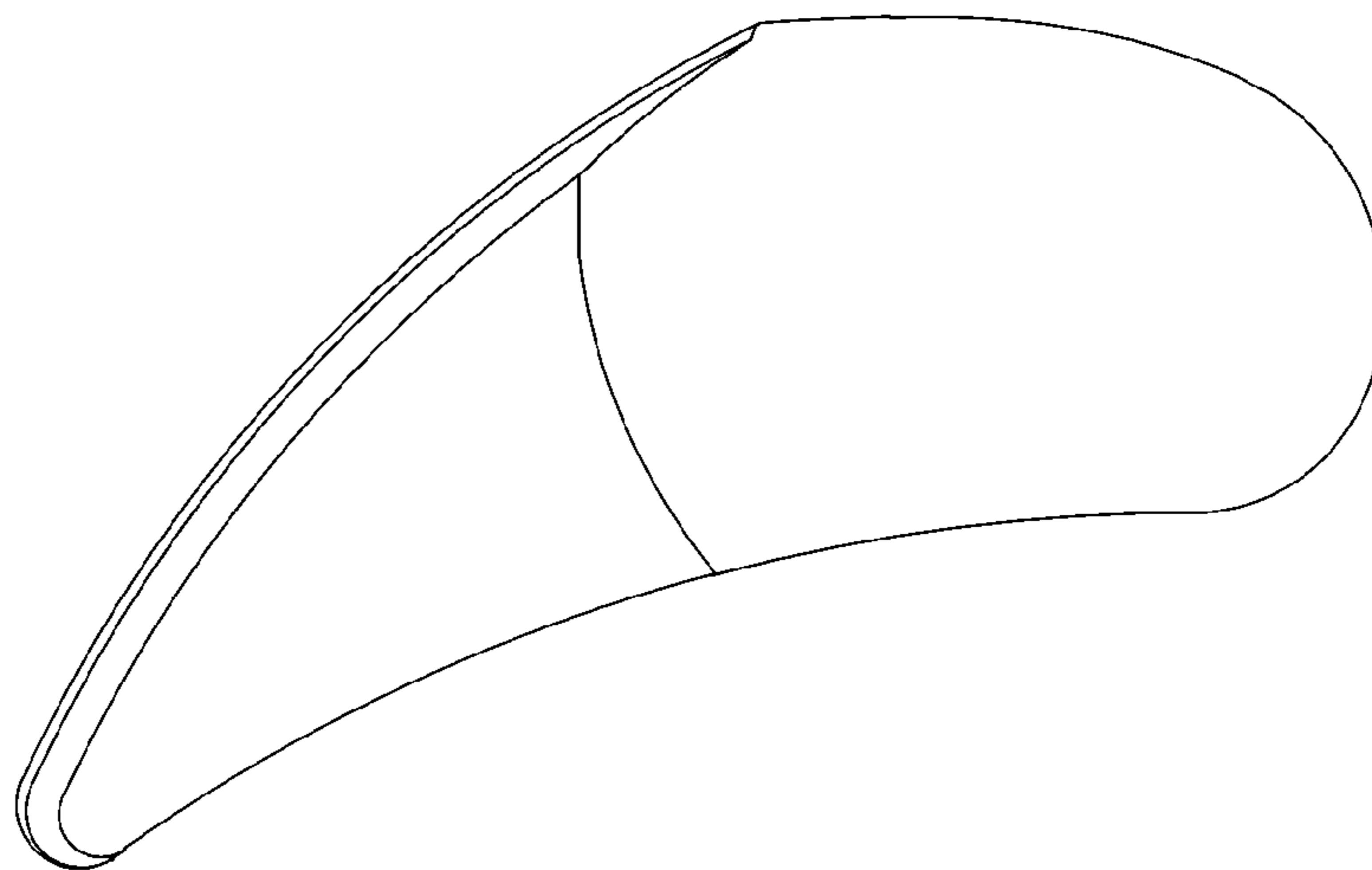

Fig. 5

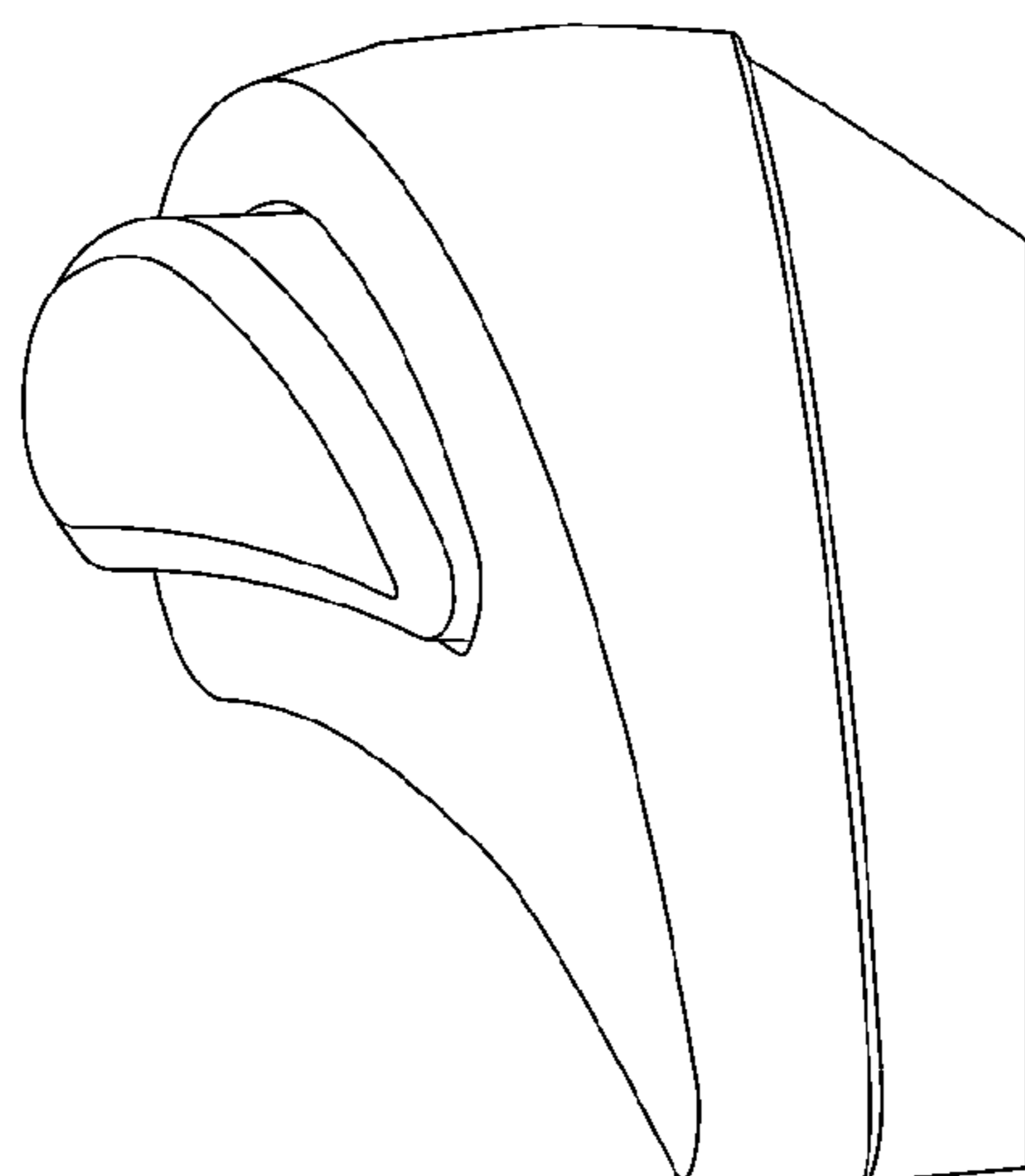

Fig. 6

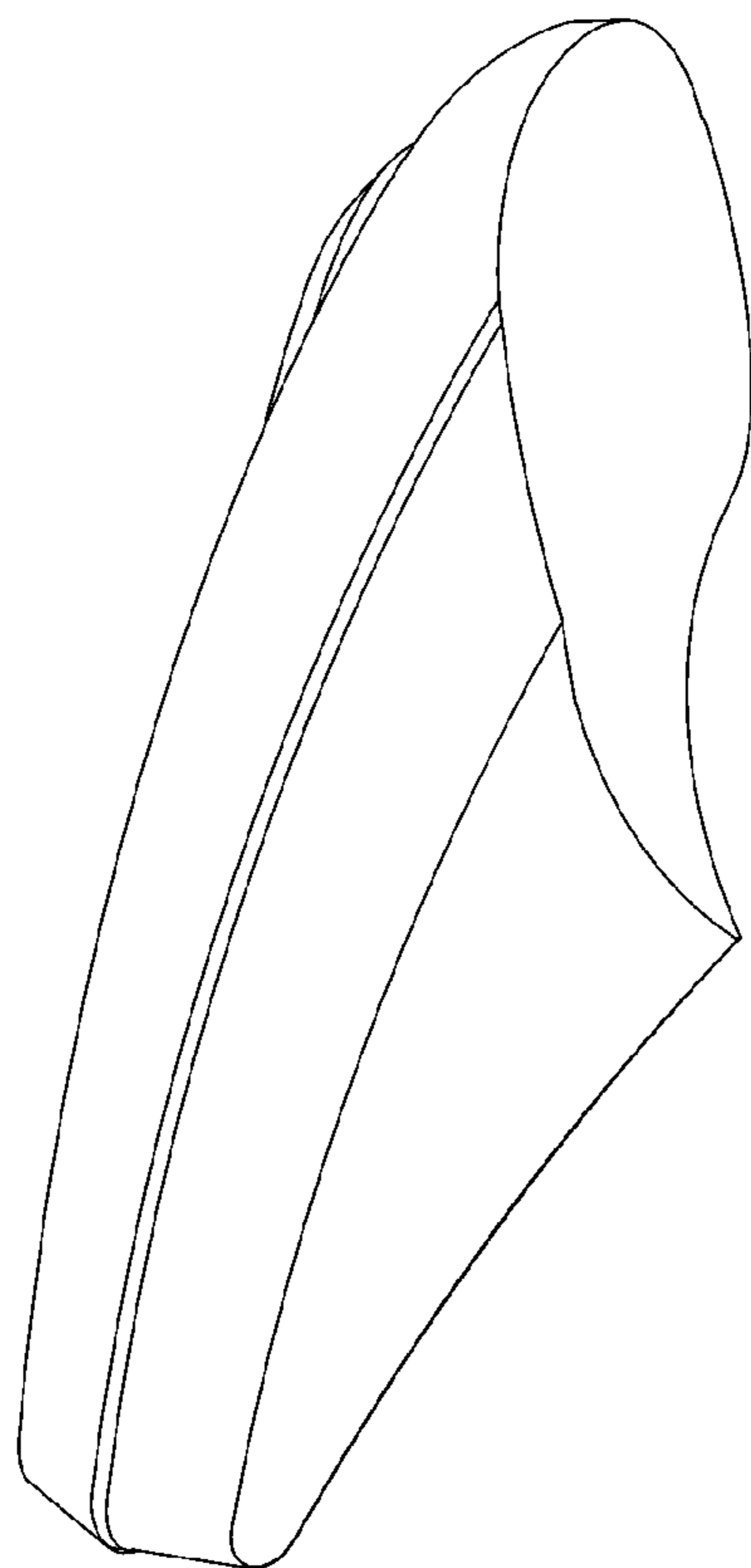

Fig. 7

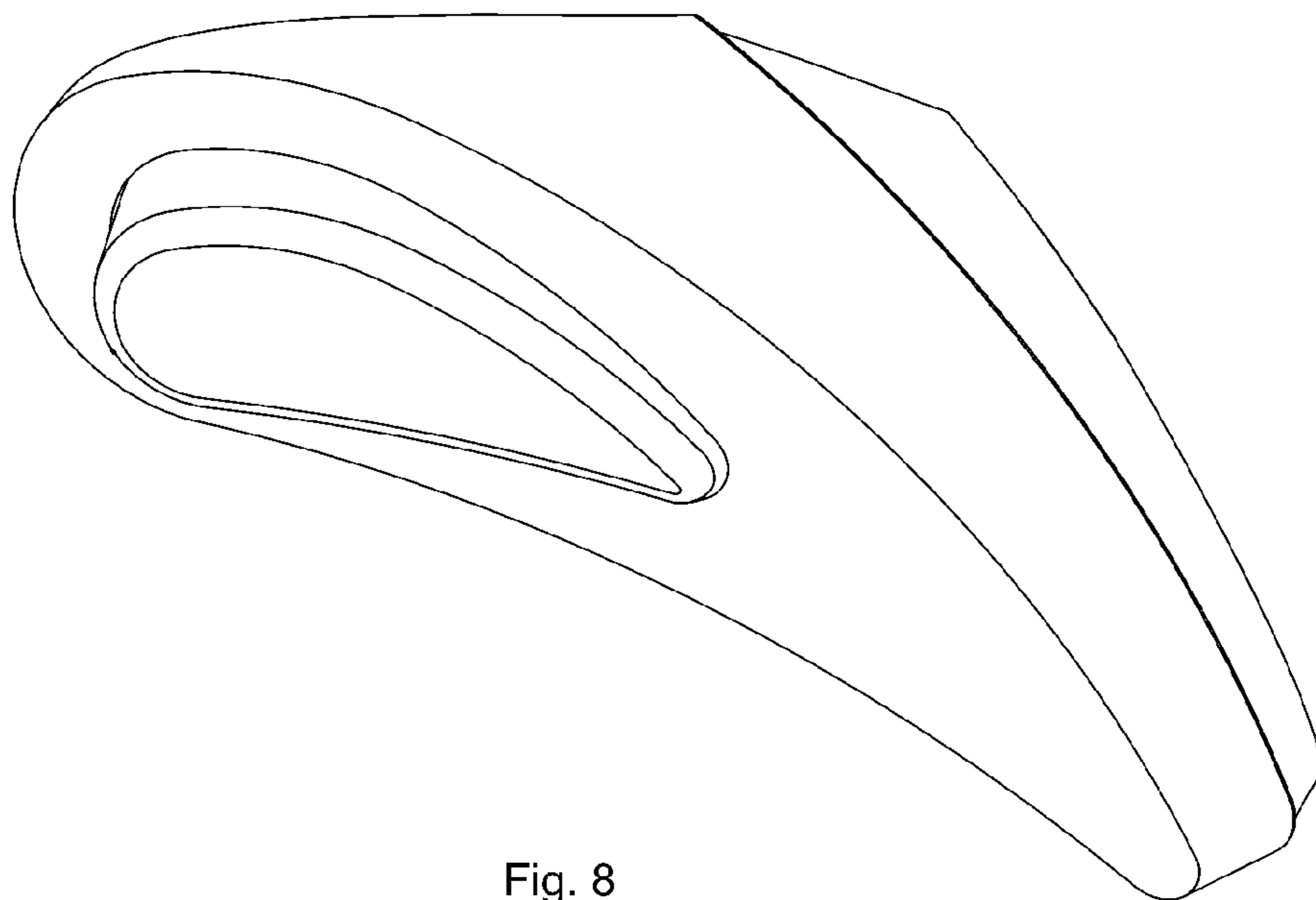

Fig. 8

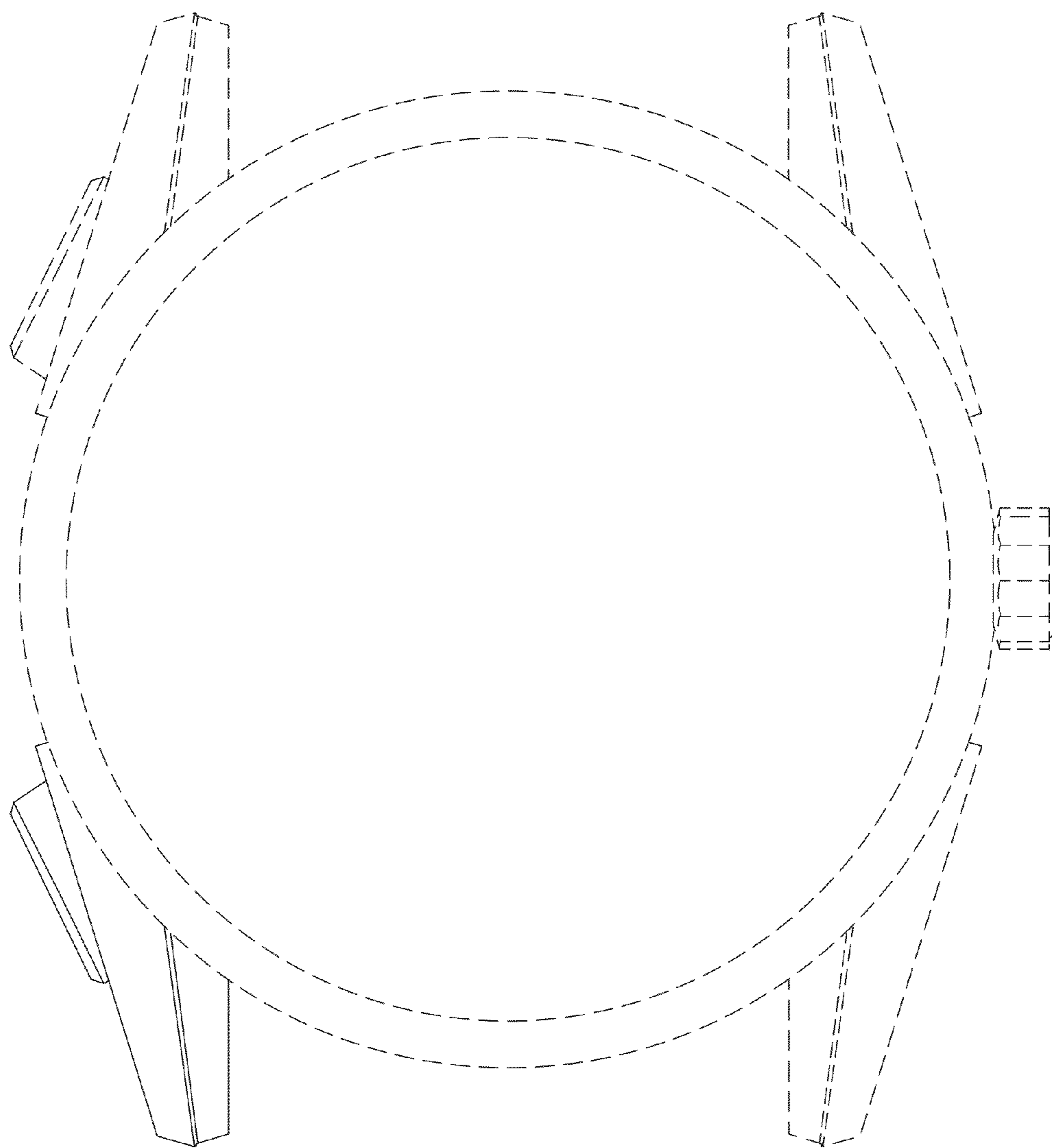

Fig. 9

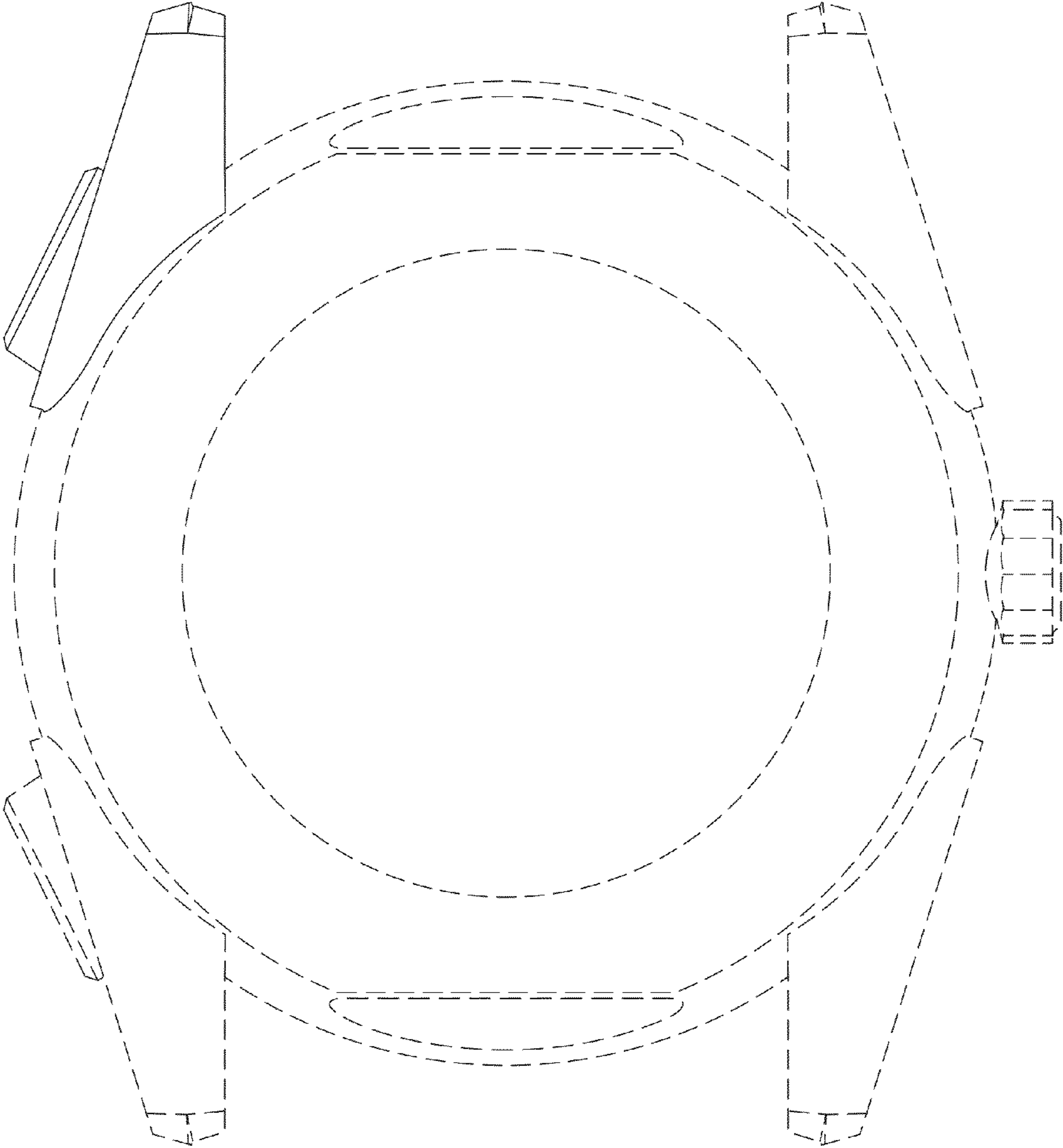

Fig. 10



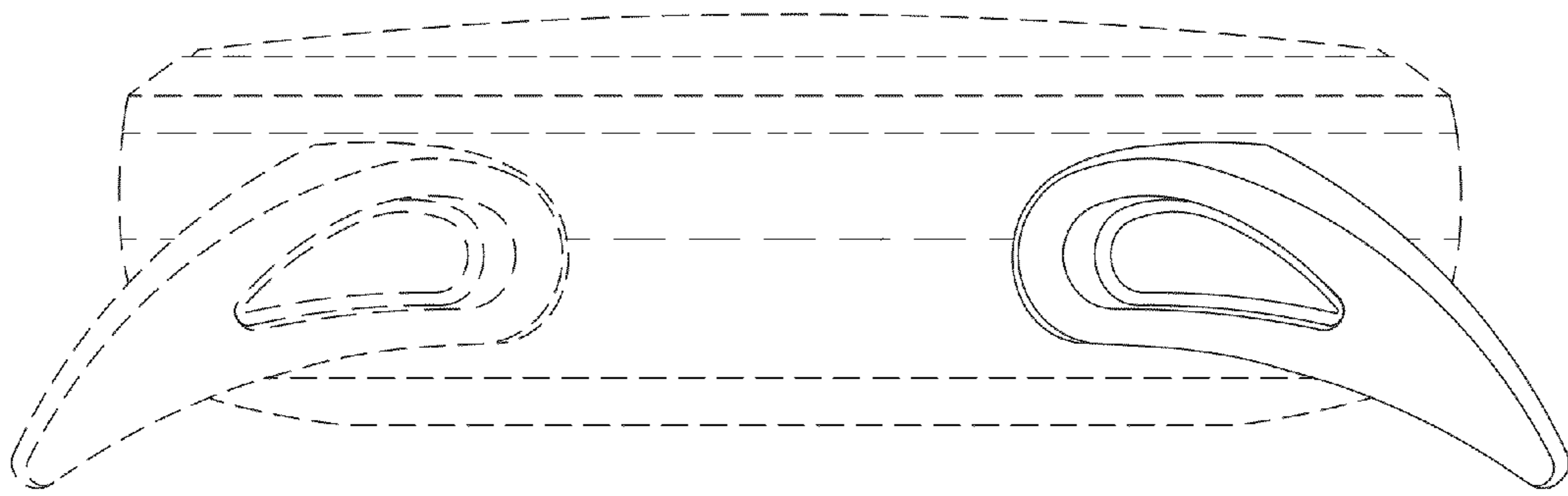

Fig. 11

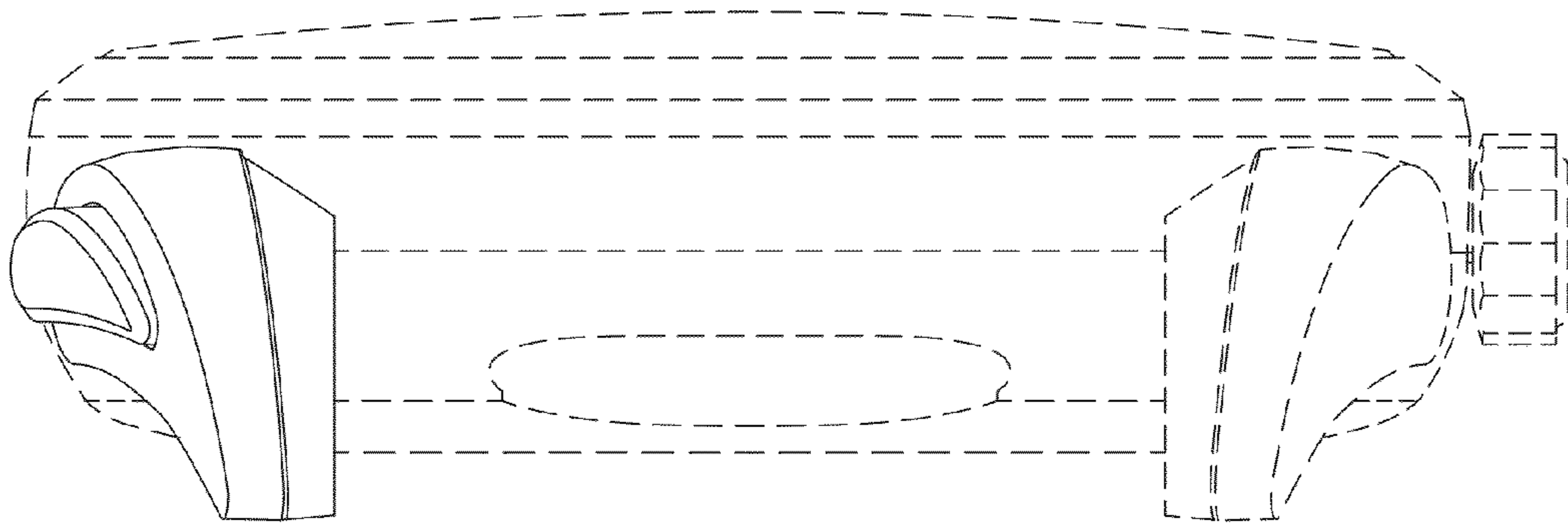

Fig. 12

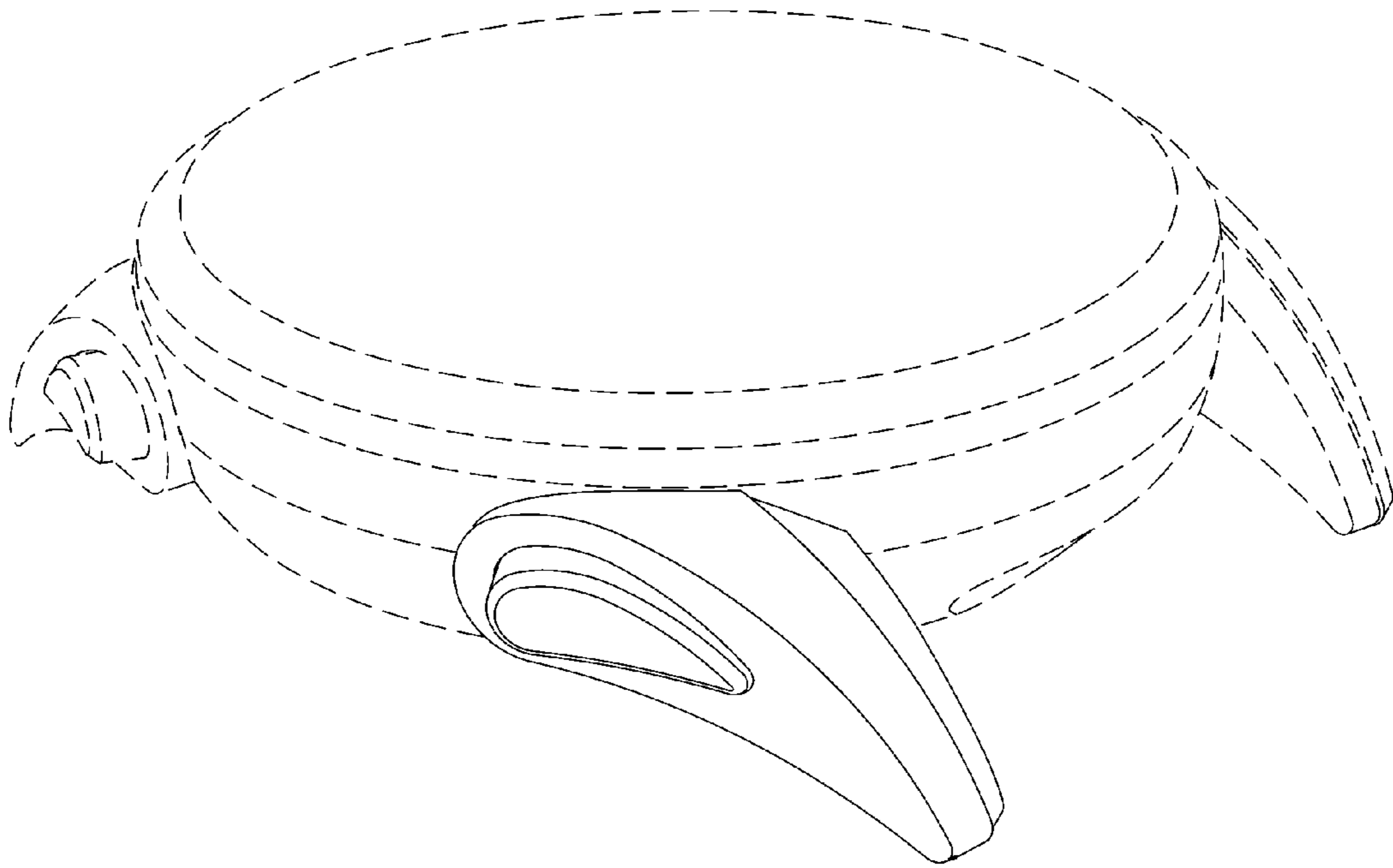

Fig. 13

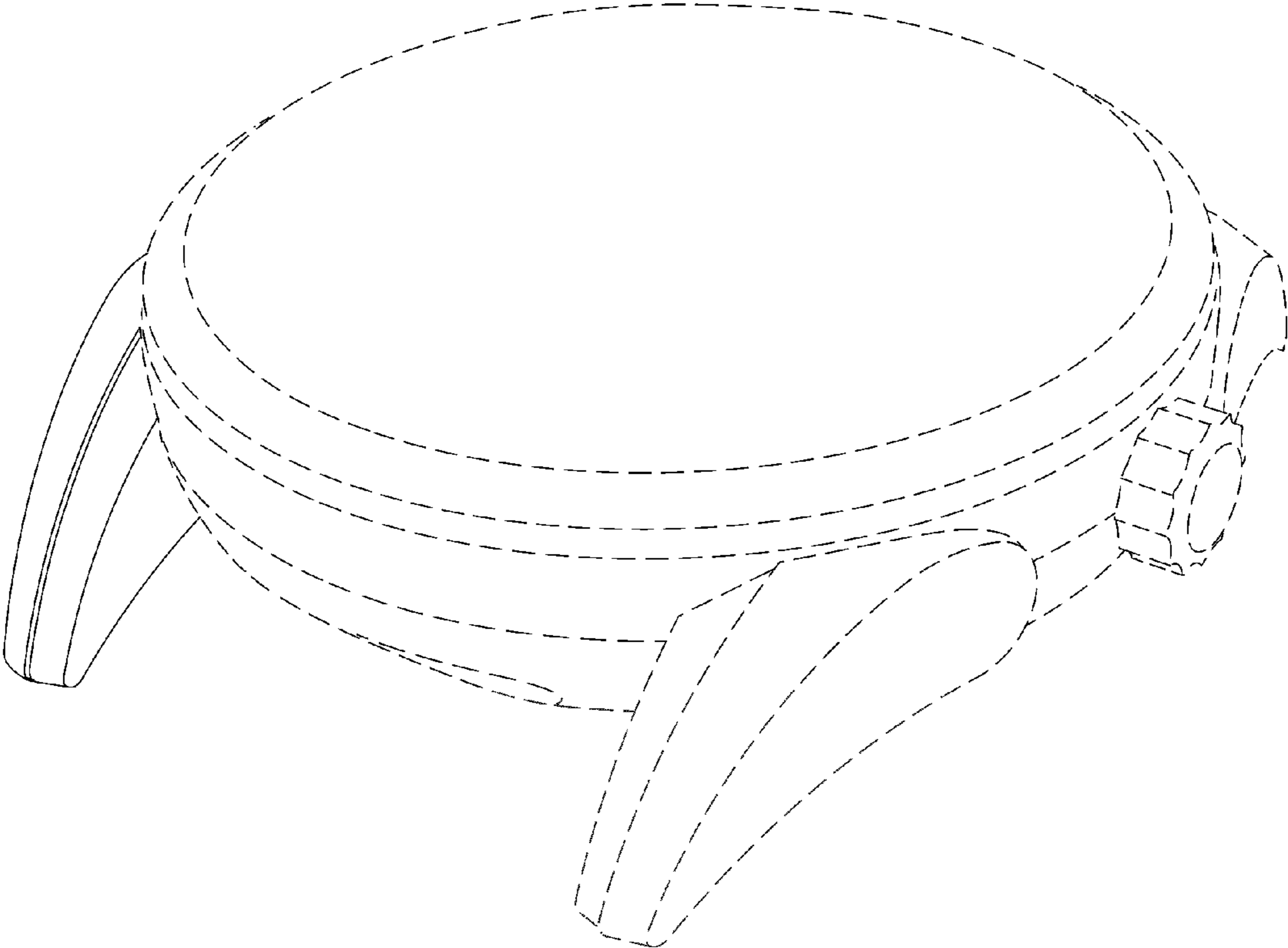

Fig. 14