



US00D725479S

(12) **United States Design Patent**
Ajichi et al.

(10) **Patent No.:** **US D725,479 S**
(45) **Date of Patent:** **** Mar. 31, 2015**

(54) **PACKAGING CONTAINER**

(71) Applicant: **Otsuka Pharmaceutical Co., Ltd.**,
Tokyo (JP)

(72) Inventors: **Mutsumi Ajichi**, Tokyo (JP); **Henry Ho**,
Tokyo (JP)

(73) Assignee: **Otsuka Pharmaceutical Co., Ltd.**,
Tokyo (JP)

(**) Term: **14 Years**

(21) Appl. No.: **29/461,034**

(22) Filed: **Jul. 17, 2013**

(30) **Foreign Application Priority Data**

Jan. 18, 2013 (JP) D2013-000833
Jan. 24, 2013 (JP) D2013-001246

(51) **LOC (10) Cl.** **09-01**

(52) **U.S. Cl.**
USPC **D9/629; D9/500**

(58) **Field of Classification Search**
USPC D9/600, 629, 652, 669, 414, 430-434,
D9/500-504, 516, 549-550, 730, 734;
206/494, 457, 527, 540, 830; 215/400;
220/260, 890; 229/116.1, 116.2
See application file for complete search history.

(56) **References Cited**

U.S. PATENT DOCUMENTS

D285,657 S * 9/1986 Poore D9/734
D323,618 S 2/1992 Arai et al.

(Continued)

FOREIGN PATENT DOCUMENTS

JP 1349777 S 1/2009
JP D1443701 S 6/2012

(Continued)

Primary Examiner — Sandra Morris

(74) *Attorney, Agent, or Firm* — Blakely Sokoloff Taylor &
Zafman

(57) **CLAIM**

The ornamental design for a packaging container, as shown and described.

DESCRIPTION

The patent or application file contains at least one drawing executed in color. Copies of this patent or patent application publication with color drawing(s) will be provided by the Office upon request and payment of the necessary fee.

FIG. 1 is a front elevational view of a packaging container of the present invention.

FIG. 2 is a rear elevational view of the packaging container of FIG. 1.

FIG. 3 is a top plan view of the packaging container of FIG. 1.

FIG. 4 is a bottom plan view of the packaging container of FIG. 1.

FIG. 5 is a left side elevational view of the packaging container of FIG. 1.

FIG. 6 is a right side elevational view of the packaging container of FIG. 1.

FIG. 7 is a perspective view of the packaging container of FIG. 1.

FIG. 8 is a front elevational view of a second embodiment of the packaging container of the present invention.

FIG. 9 is a rear elevational view of the packaging container of FIG. 8.

FIG. 10 is a top plan view of the packaging container of FIG. 8.

FIG. 11 is a bottom plan view of the packaging container of FIG. 8.

FIG. 12 is a left side elevational view of the packaging container of FIG. 8.

FIG. 13 is a right side elevational view of the packaging container of FIG. 8; and,

FIG. 14 is a perspective view of the packaging container of FIG. 8.

The broken lines in FIG. 8 and FIG. 11 are included for the purpose of illustrating a portion of the bottom of the first embodiment and the second embodiment of the invention that forms no part of the claimed design.

1 Claim, 14 Drawing Sheets
(8 of 14 Drawing Sheet(s) Filed in Color)

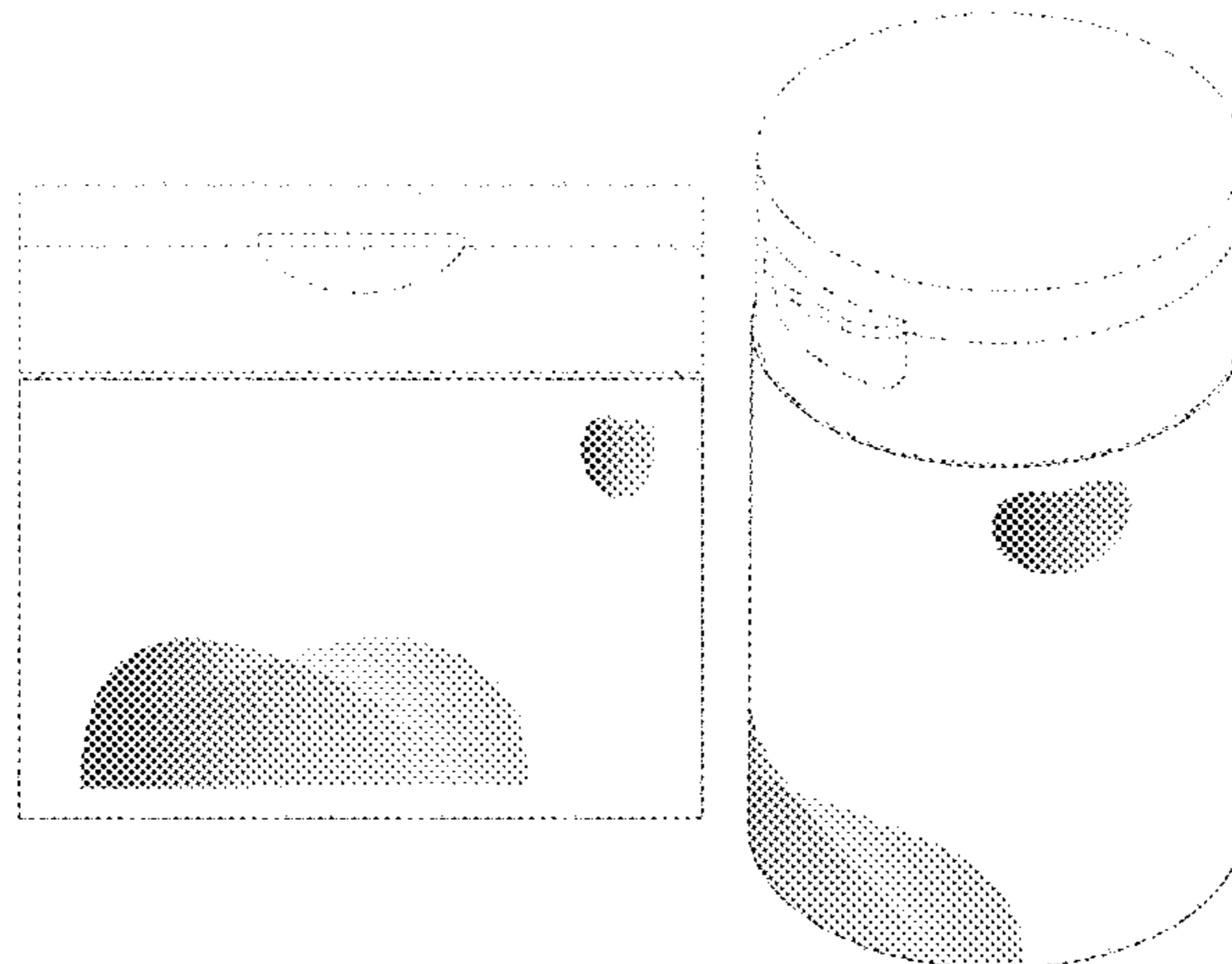

(56)

References Cited

U.S. PATENT DOCUMENTS

D428,335 S 7/2000 Toyota et al.
 D449,525 S 10/2001 Sturgess
 D568,170 S * 5/2008 Prini D9/629
 D581,263 S 11/2008 Suyama et al.
 D588,910 S * 3/2009 Kim D9/433
 D644,537 S 9/2011 Hu
 D646,578 S * 10/2011 Marais et al. D9/549
 D651,085 S * 12/2011 Frias D9/629
 D655,156 S * 3/2012 Schrimpf et al. D9/432
 D656,019 S * 3/2012 Norman et al. D9/434

D661,985 S * 6/2012 Macaulay et al. D9/500
 D680,864 S * 4/2013 Thompson et al. D9/434
 D680,865 S * 4/2013 Thompson et al. D9/434
 D683,216 S * 5/2013 Thompson et al. D9/434
 D683,217 S * 5/2013 Thompson et al. D9/434
 D683,218 S * 5/2013 Thompson et al. D9/434
 D686,067 S * 7/2013 Macaulay et al. D9/434

FOREIGN PATENT DOCUMENTS

TW D126213 12/2008
 TW D140786 6/2011

* cited by examiner

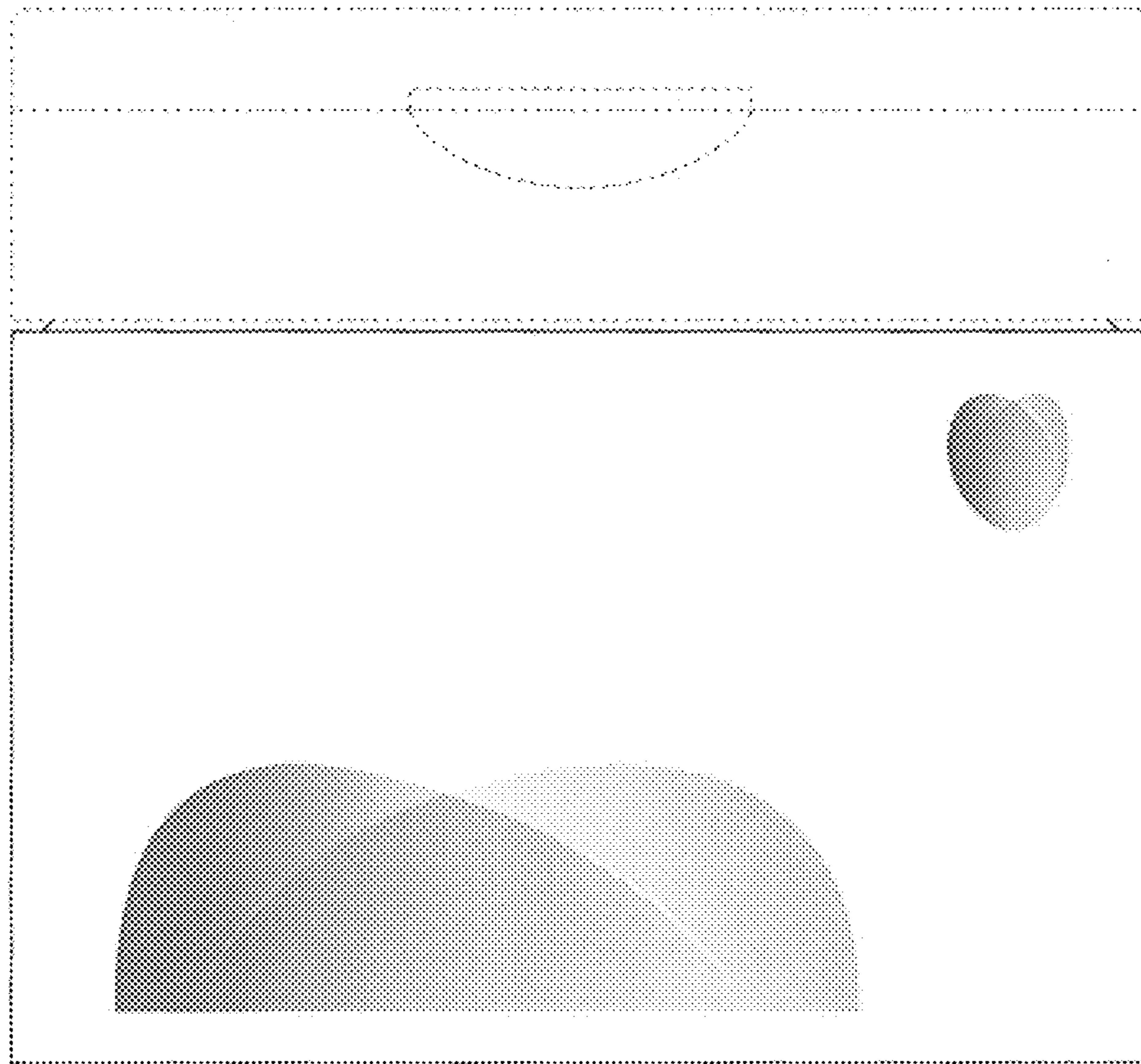

FIG. 1

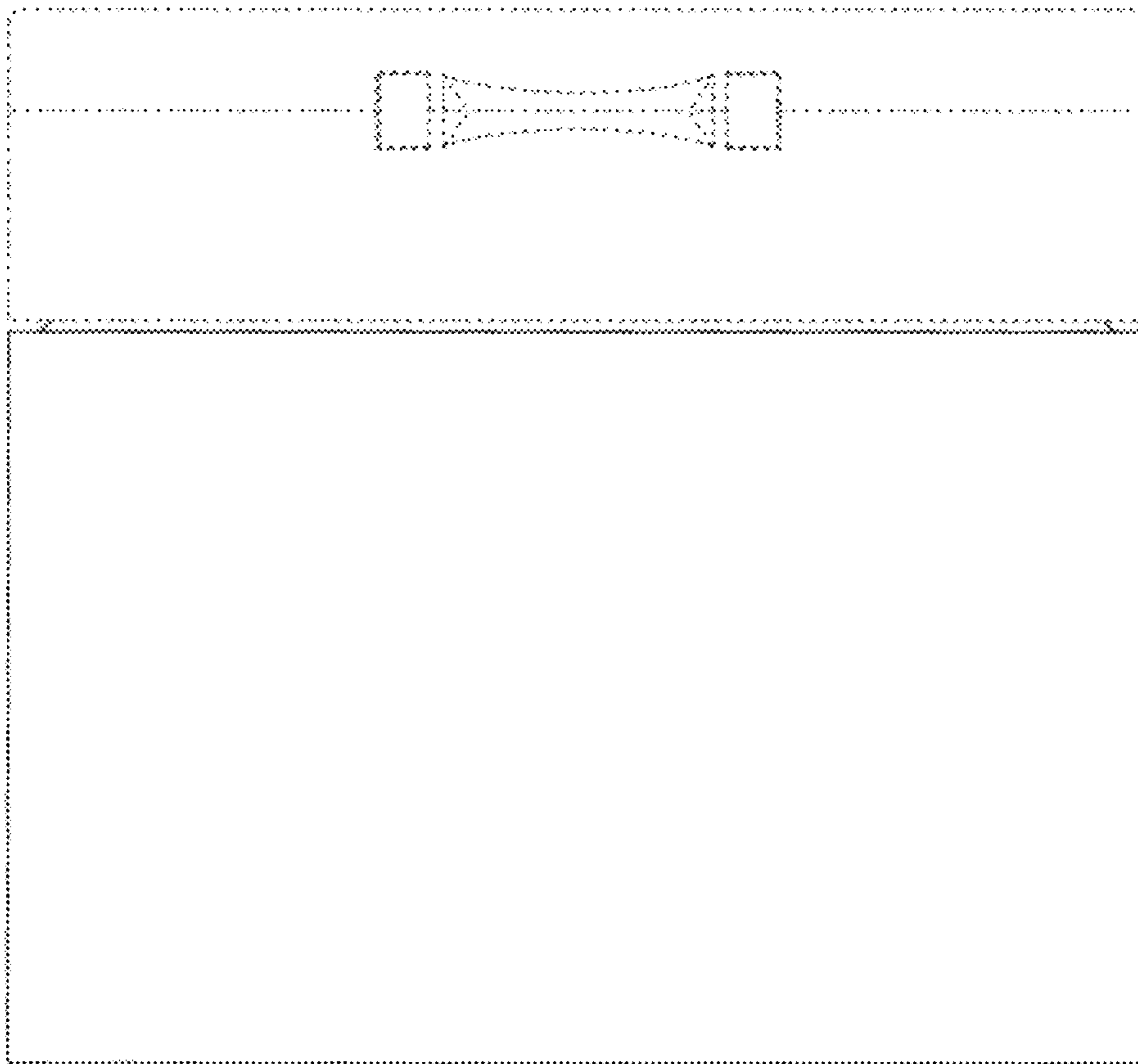

FIG. 2

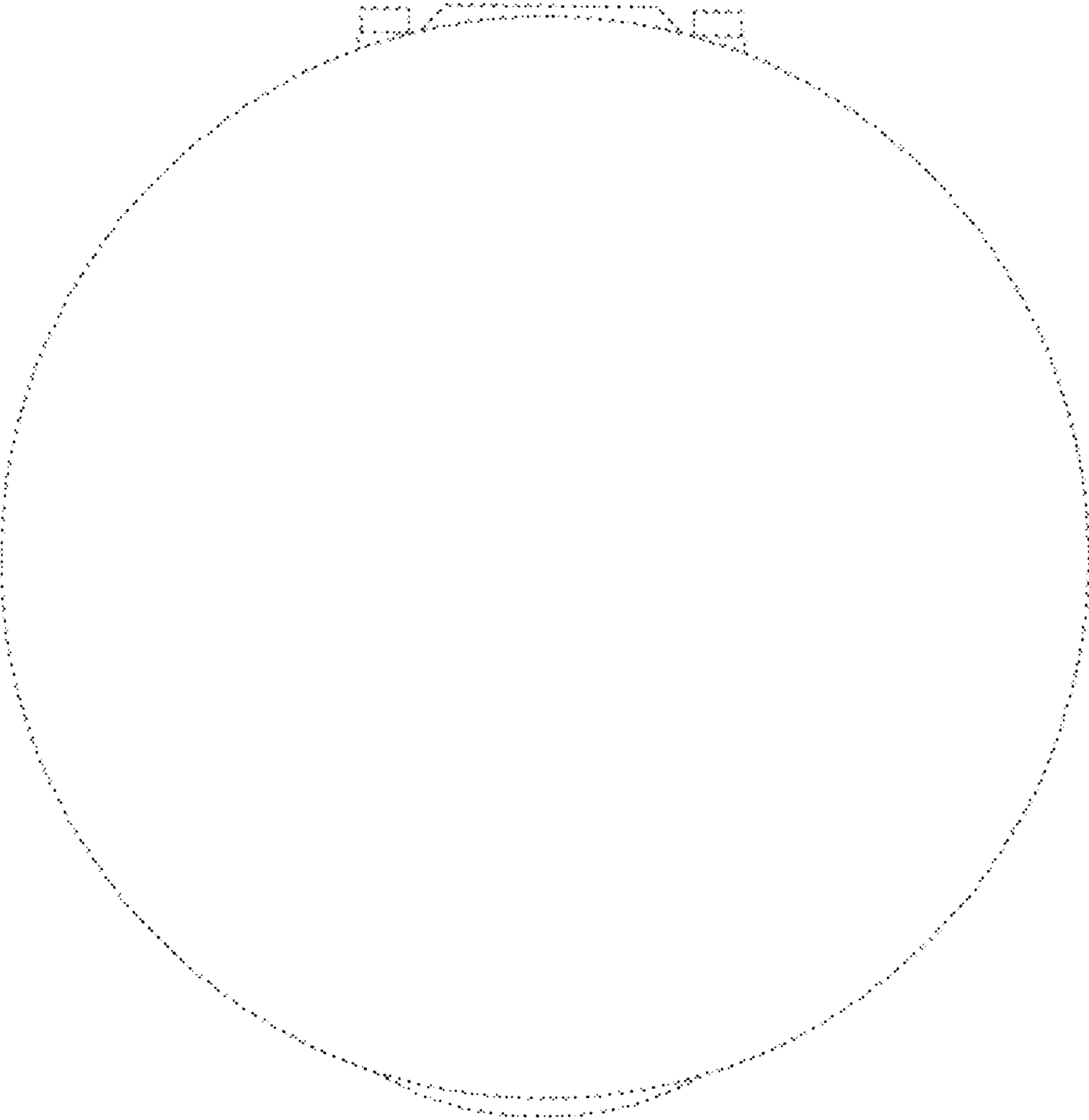

FIG. 3

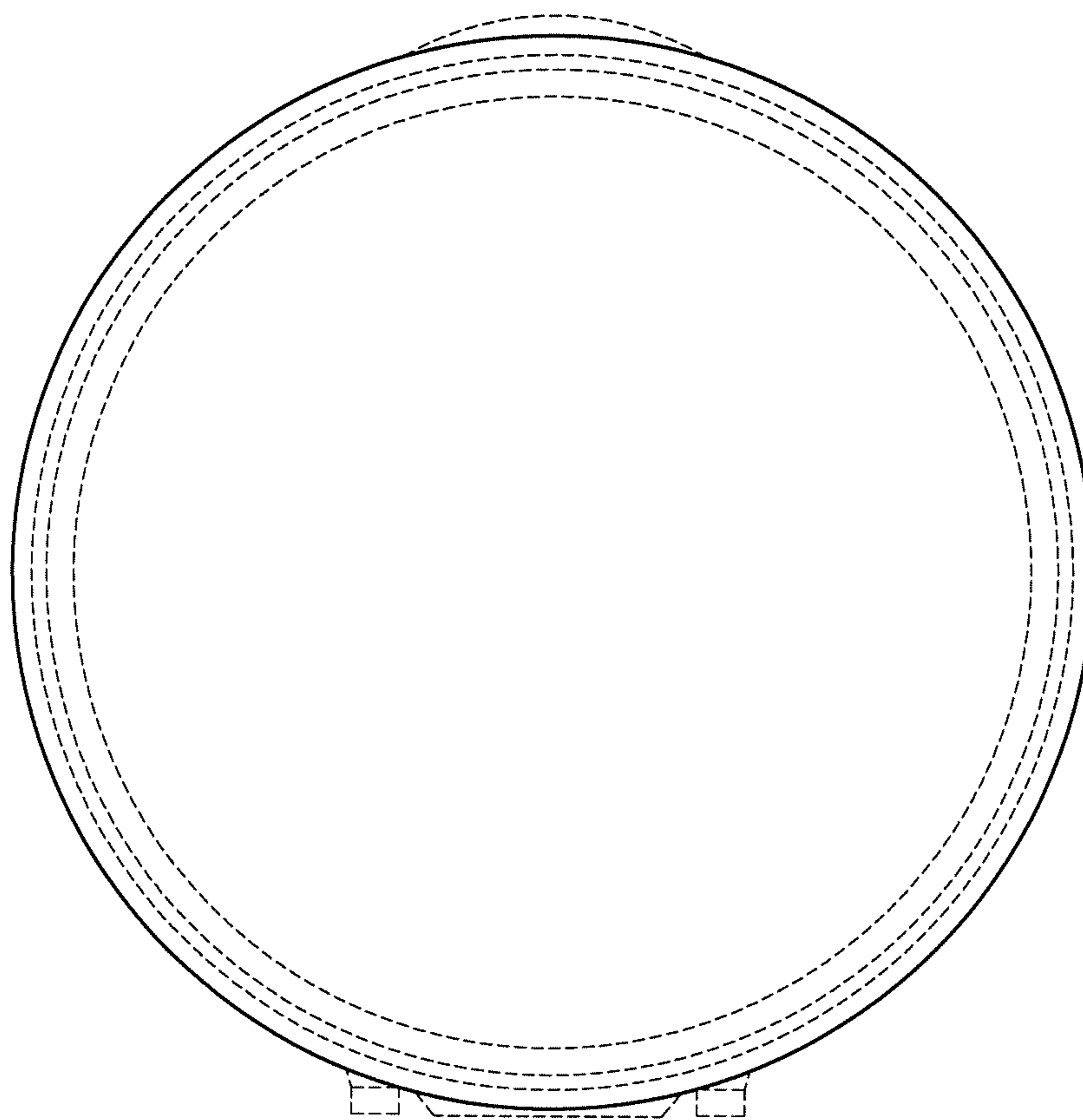

FIG. 4

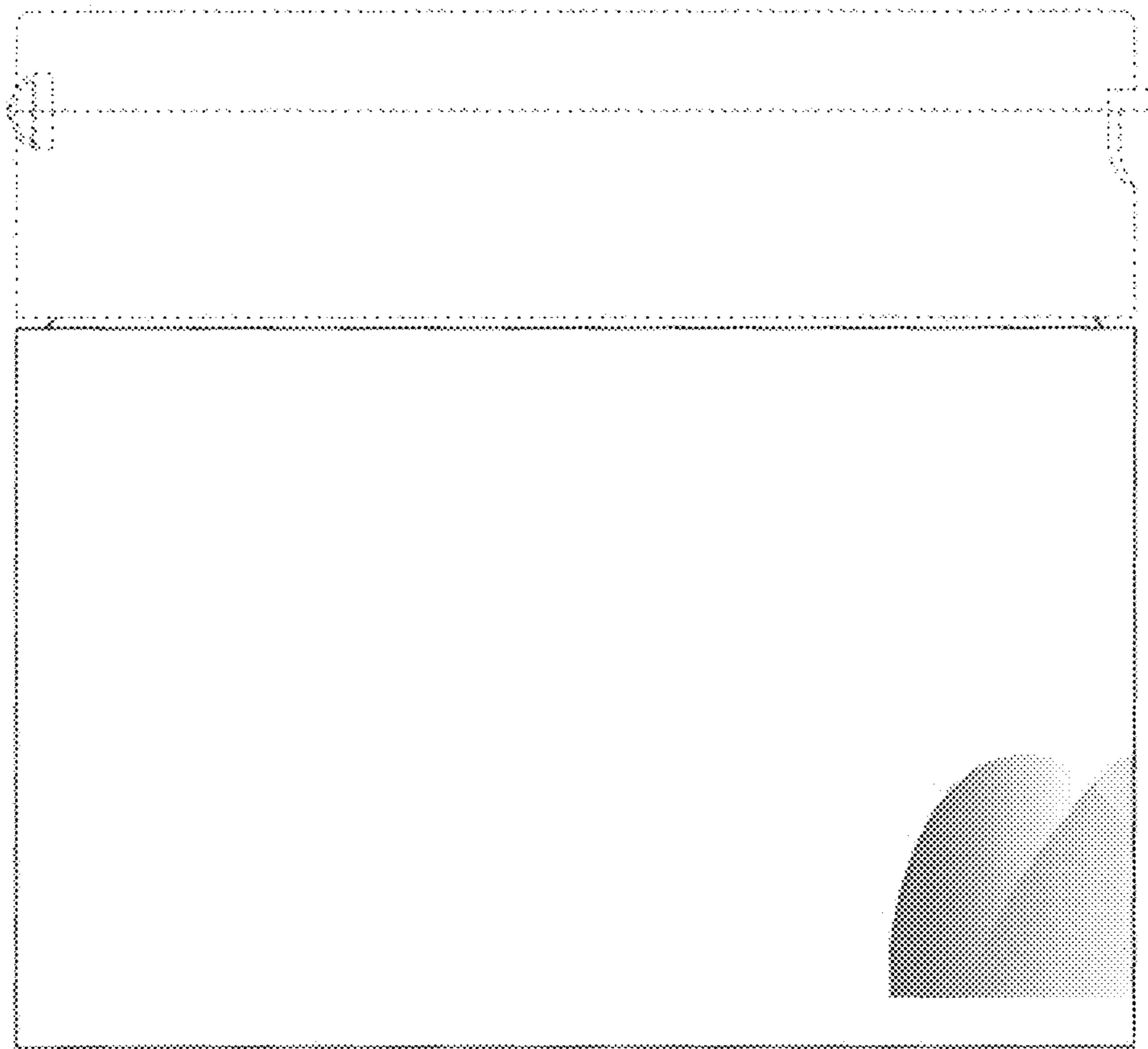

FIG. 5

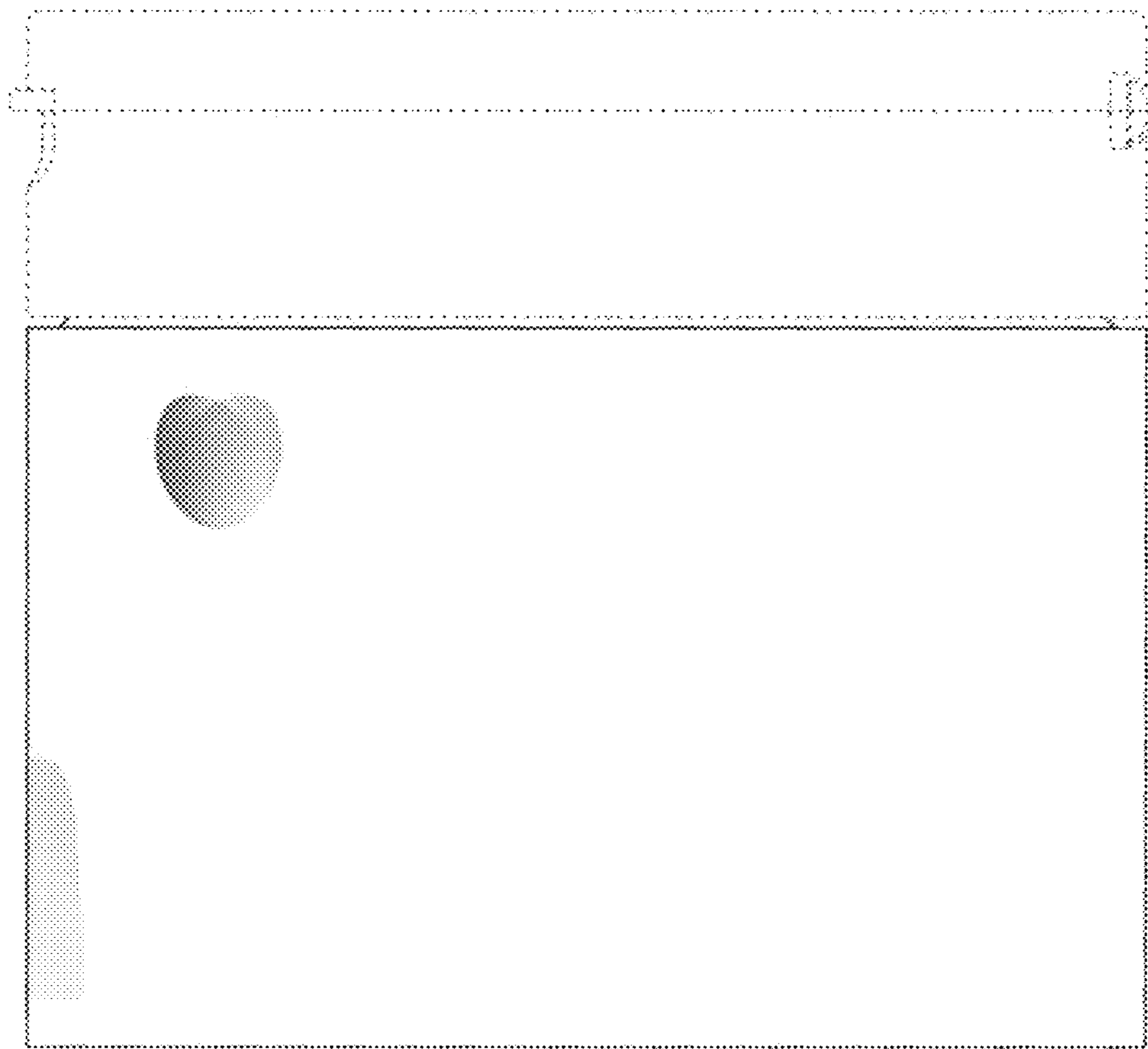

FIG. 6

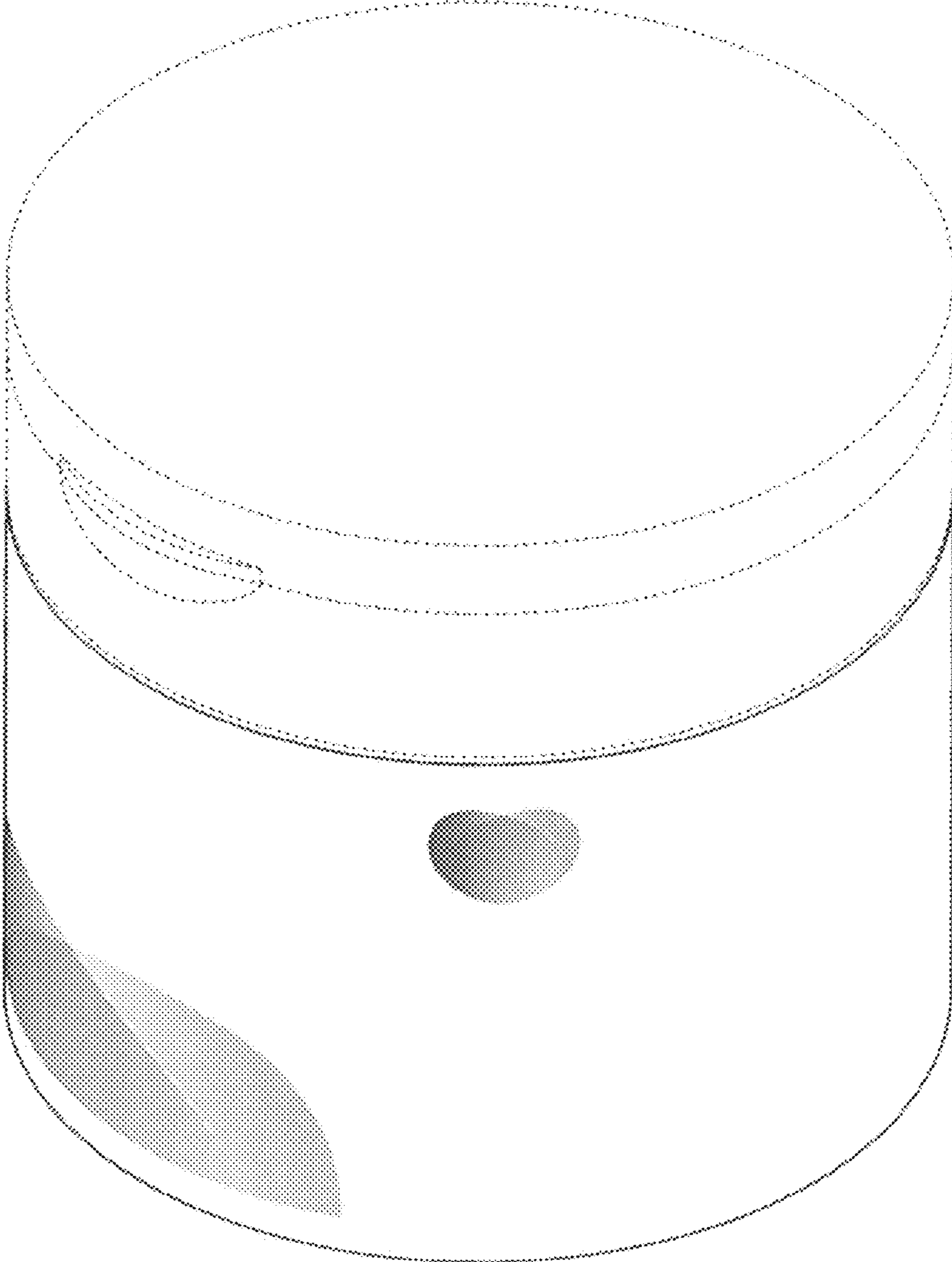

FIG. 7

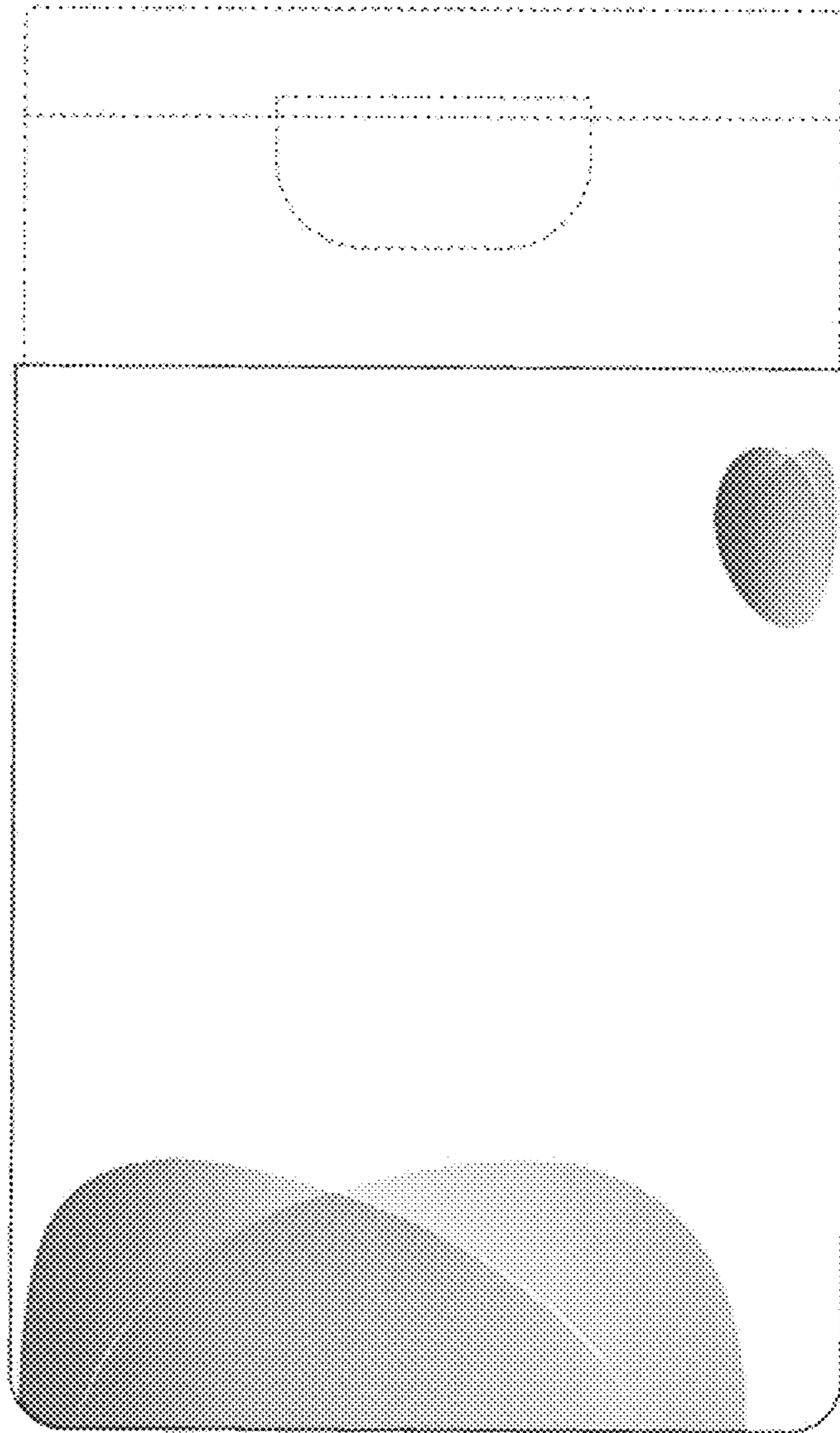

FIG. 8

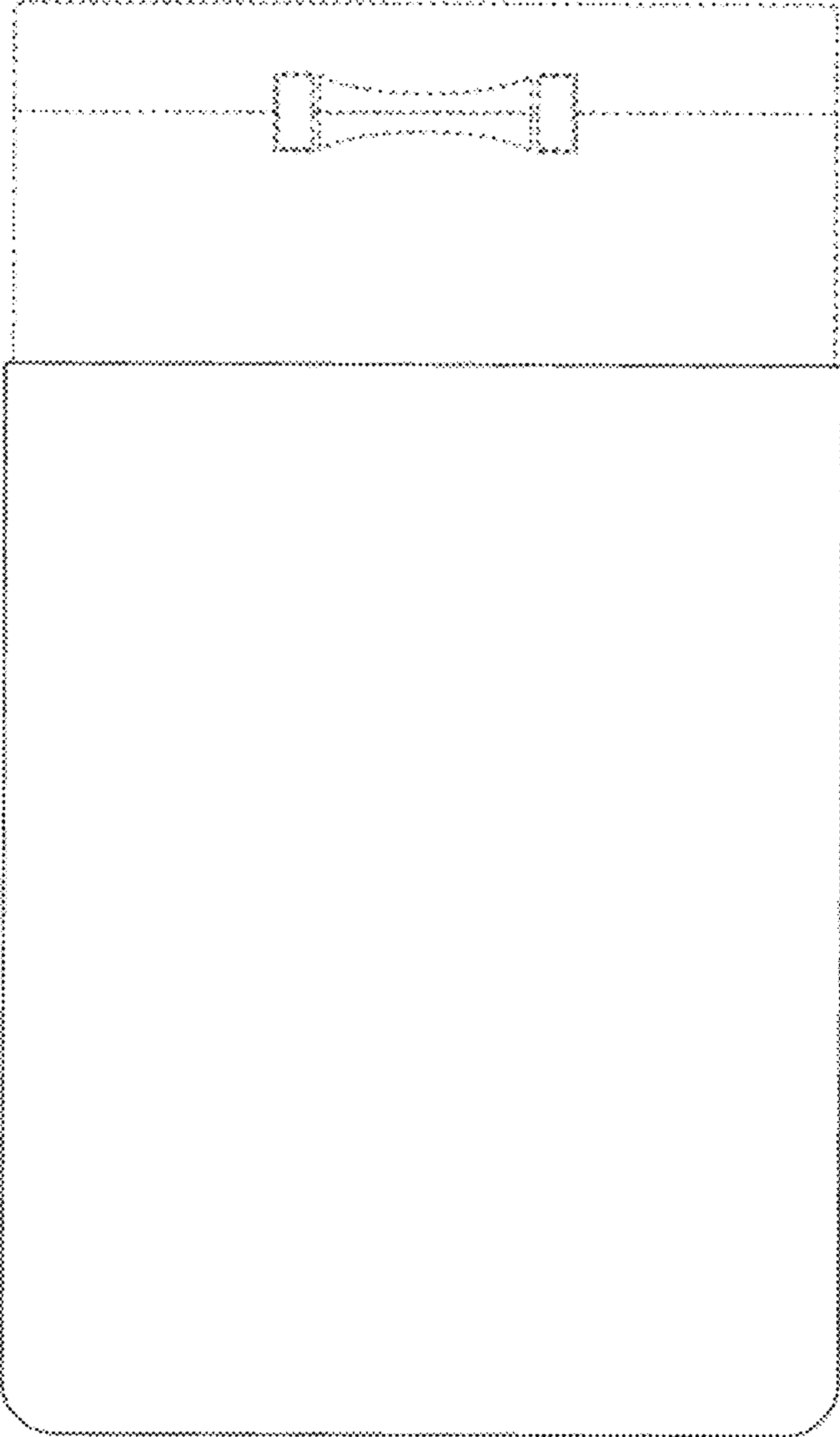

FIG. 9

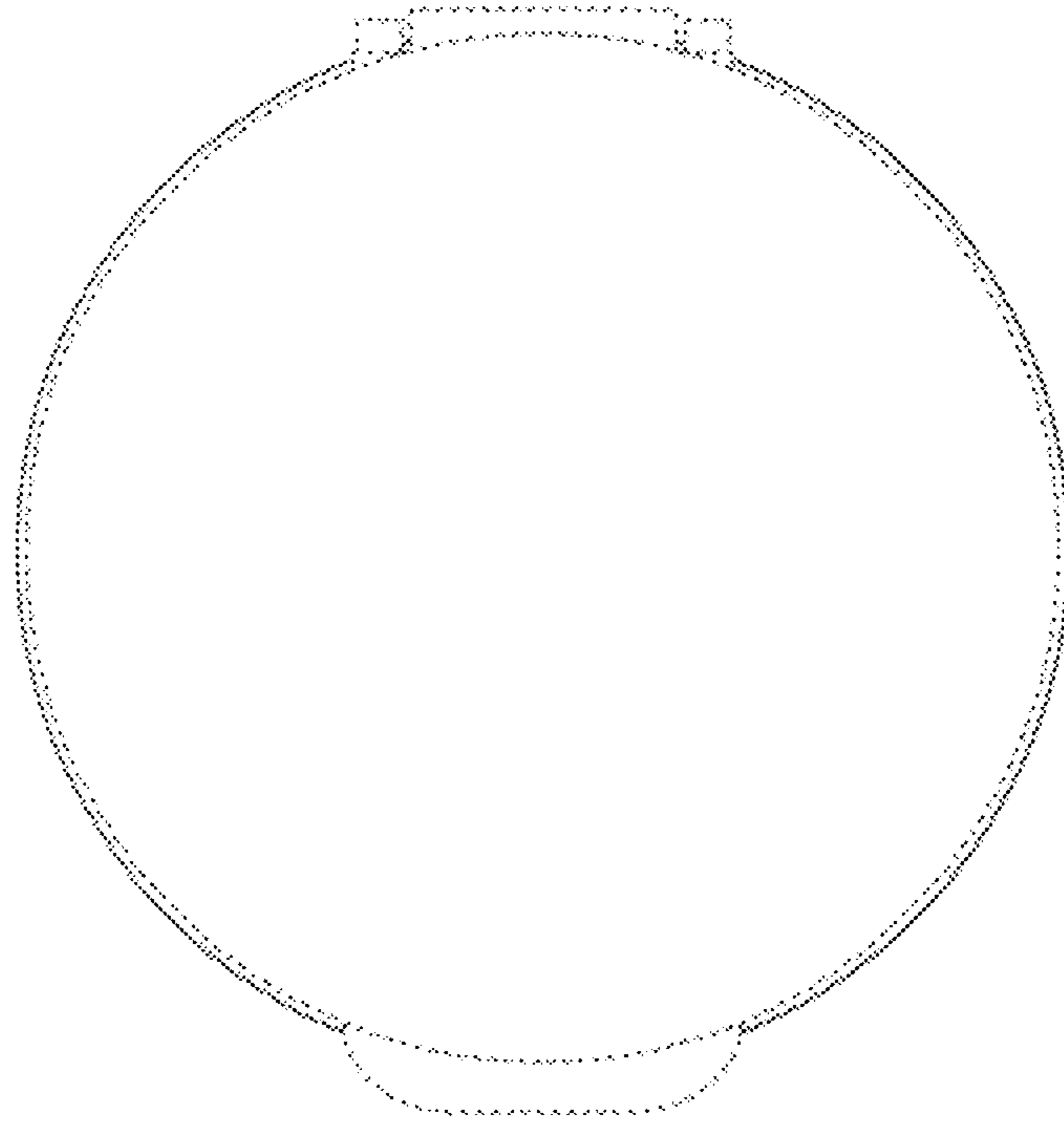

FIG. 10

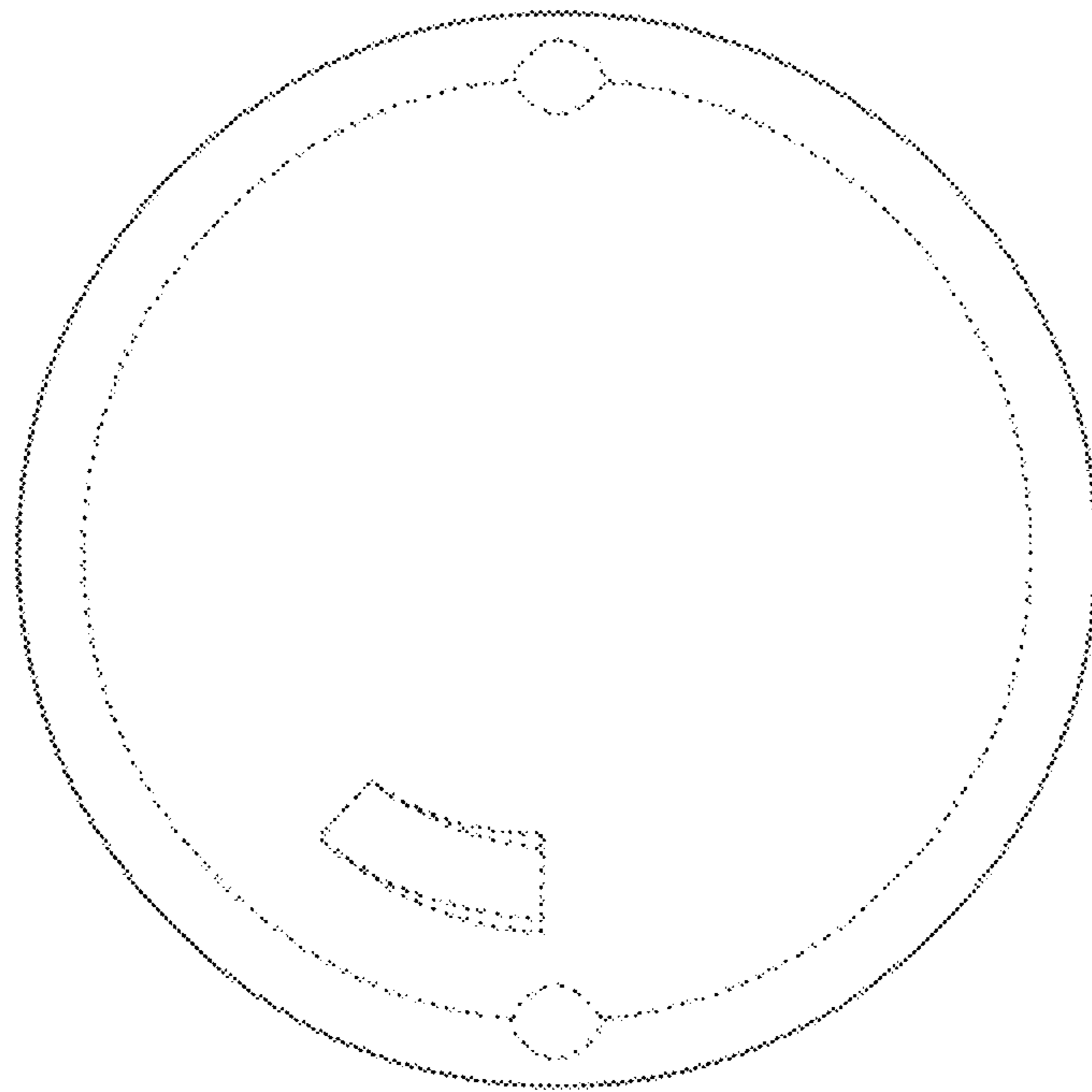

FIG. 11

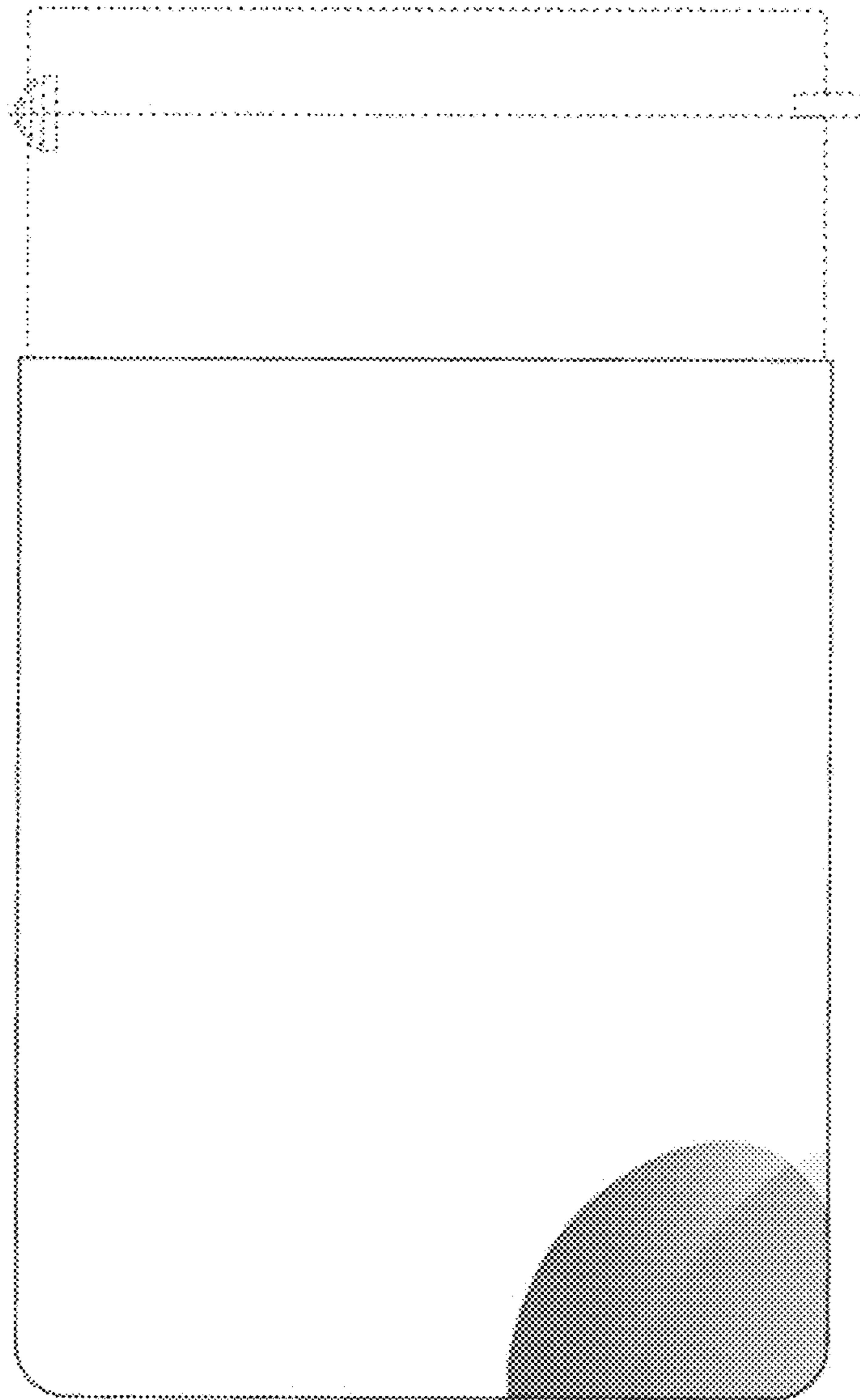

FIG. 12

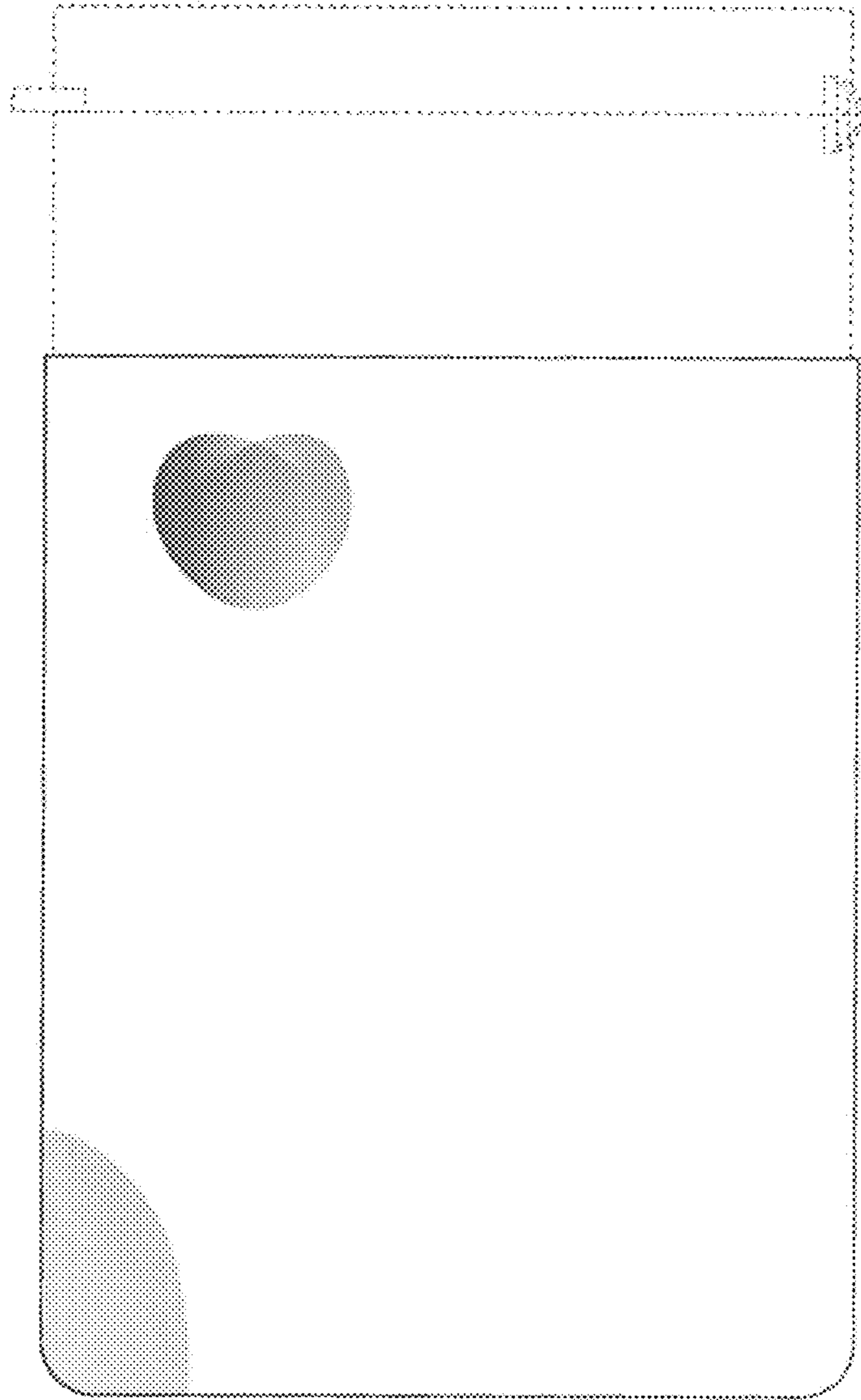

FIG. 13

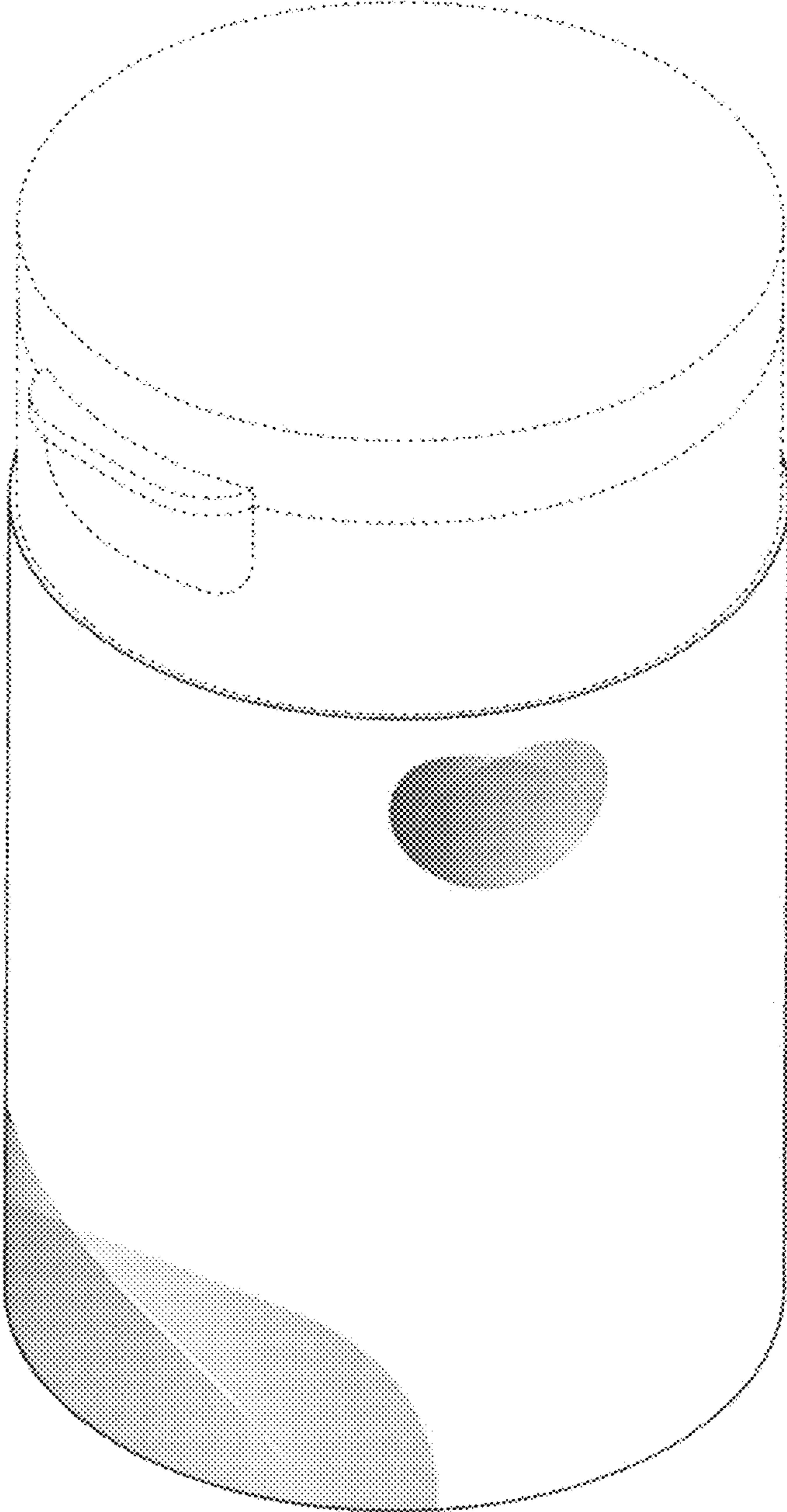

FIG. 14