



US00D725404S

(12) **United States Design Patent**
Archer et al.

(10) **Patent No.:** **US D725,404 S**
(45) **Date of Patent:** **** Mar. 31, 2015**

(54) **DISPENSER CAP**

(71) Applicant: **GOJO Industries, Inc**, Akron, OH (US)

(72) Inventors: **Matthew J Archer**, Aurora, OH (US);
Timothy M Cambier, Uniontown, OH (US); **Jeffrey W Hall**, Hudson, OH (US); **Mark W Moore**, Aurora, OH (US); **Jonathan D Lewandowski**, Cheektowaga, NY (US); **Martin J O'Toole**, Chagrin Falls, OH (US); **David A Urbanic**, Strongsville, OH (US)

(73) Assignee: **GOJO Industries, Inc**, Akron, OH (US)

(**) Term: **14 Years**

(21) Appl. No.: **29/468,442**

(22) Filed: **Sep. 30, 2013**

(51) **LOC (10) Cl.** **23-02**

(52) **U.S. Cl.**
USPC **D6/545**

(58) **Field of Classification Search**
USPC D6/542-545; 221/208, 282, 283;
222/105, 173, 180, 181.1, 181.2, 181.3
See application file for complete search history.

(56) **References Cited**

U.S. PATENT DOCUMENTS

D379,045 S *	5/1997	Andrus et al.	D6/544
D441,581 S *	5/2001	Andersson	D6/545
D592,899 S *	5/2009	Dukes	D6/545
D687,652 S *	8/2013	Lin	D6/542

* cited by examiner

Primary Examiner — Brian N Vinson

(74) *Attorney, Agent, or Firm* — Timothy D. Smith

(57) **CLAIM**

The ornamental design for a dispenser cap, as shown and described.

DESCRIPTION

FIG. 1 is a perspective view of a first embodiment of a dispenser cap of the new design;
FIG. 2 is a front elevational view of the dispenser cap of FIG. 1;
FIG. 3 is a rear elevational view of the dispenser cap of FIG. 1;
FIG. 4 is a right elevational view of the dispenser cap of FIG. 1;
FIG. 5 is a left elevational view of the dispenser cap of FIG. 1;
FIG. 6 is a top plan view of the dispenser cap of FIG. 1, of which the bottom surface of the first embodiment of the dispenser cap is unornamented;
FIG. 7 is a perspective view of a second embodiment of the dispenser cap shown in FIG. 1; and
FIG. 8 is a front elevational view of the dispenser cap of FIG. 7;
FIG. 9 is a rear elevational view of the dispenser cap of FIG. 7;
FIG. 10 is a right elevational view of the dispenser cap of FIG. 7;
FIG. 11 is a left elevational view of the dispenser cap of FIG. 7; and,
FIG. 12 is a top plan view of the dispenser cap of FIG. 7, of which the bottom of the second embodiment of the dispenser cap is unornamented.

The portions of the Figures shown in broken lines are not part of the claimed design and are for illustration only. The broken line(s) which define the bounds of the claimed design form no part thereof.

1 Claim, 12 Drawing Sheets

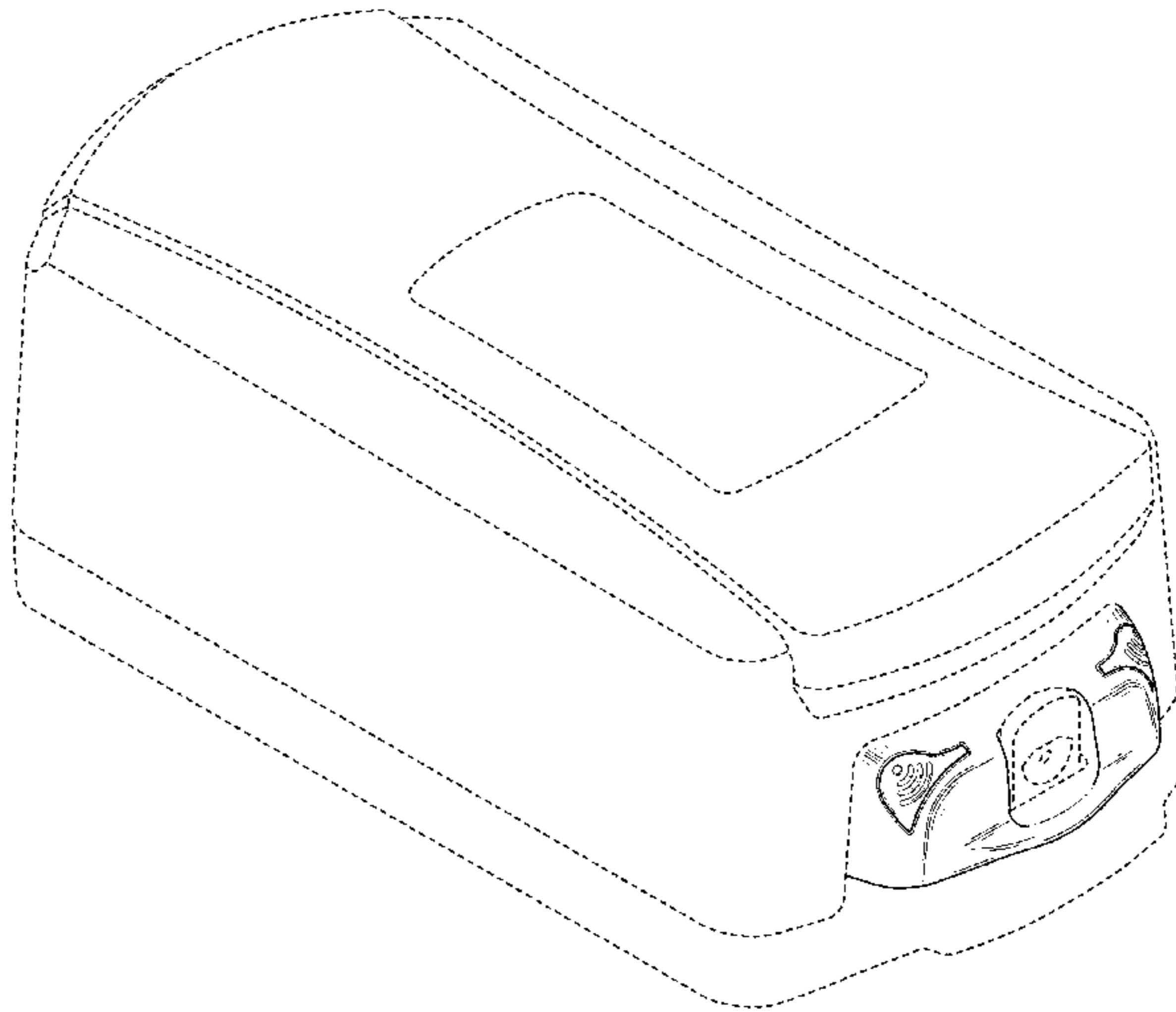
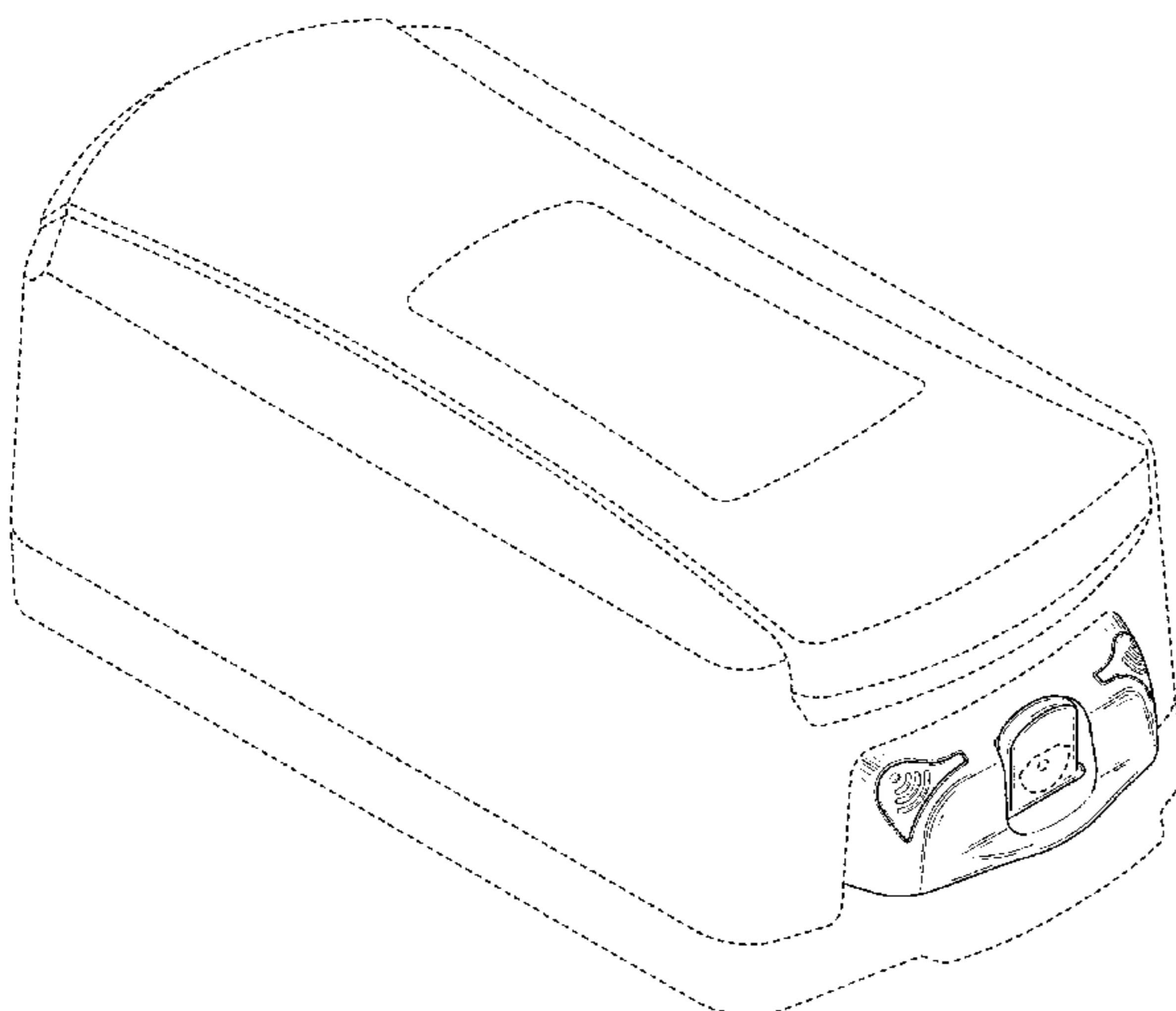

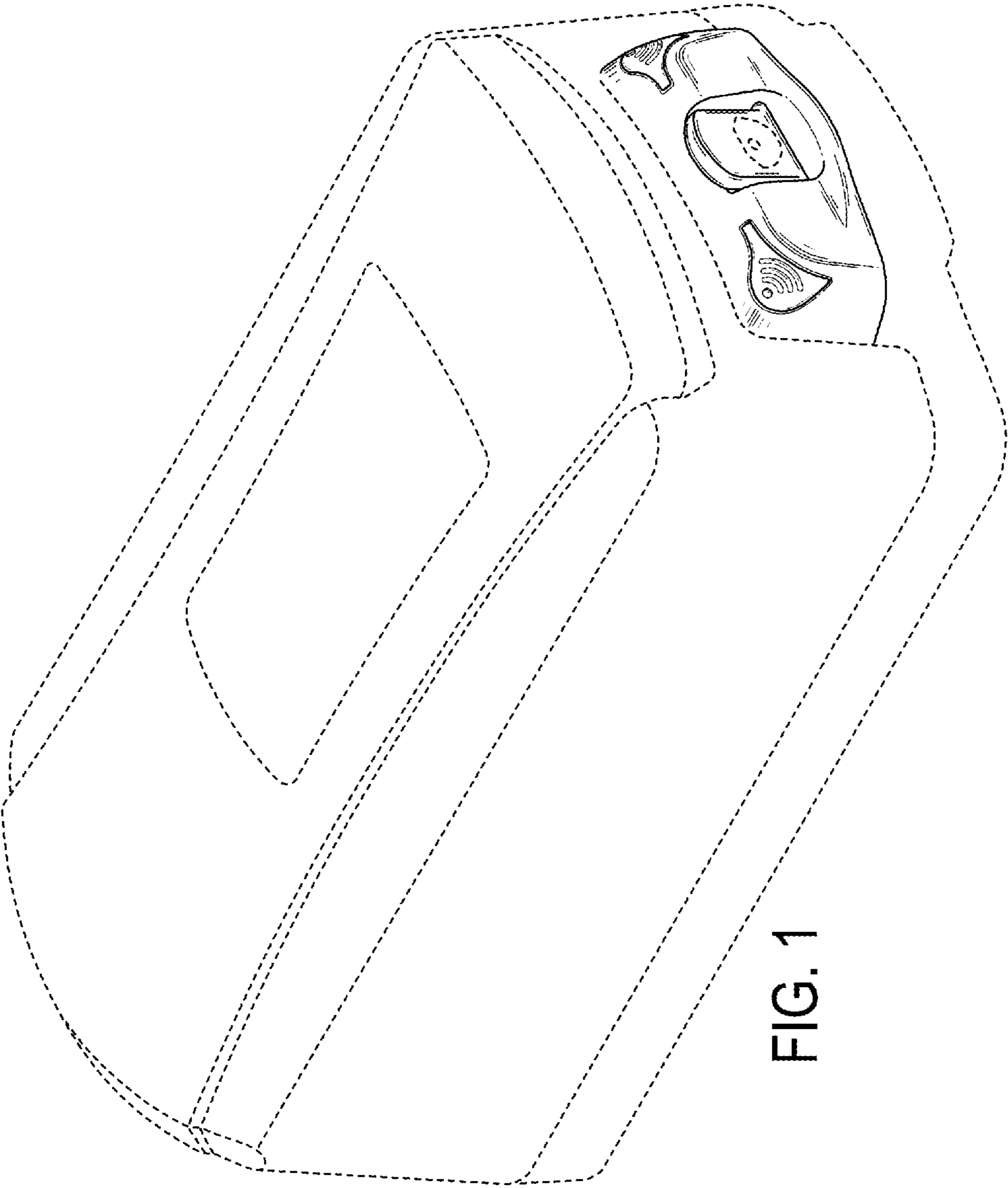

FIG. 1

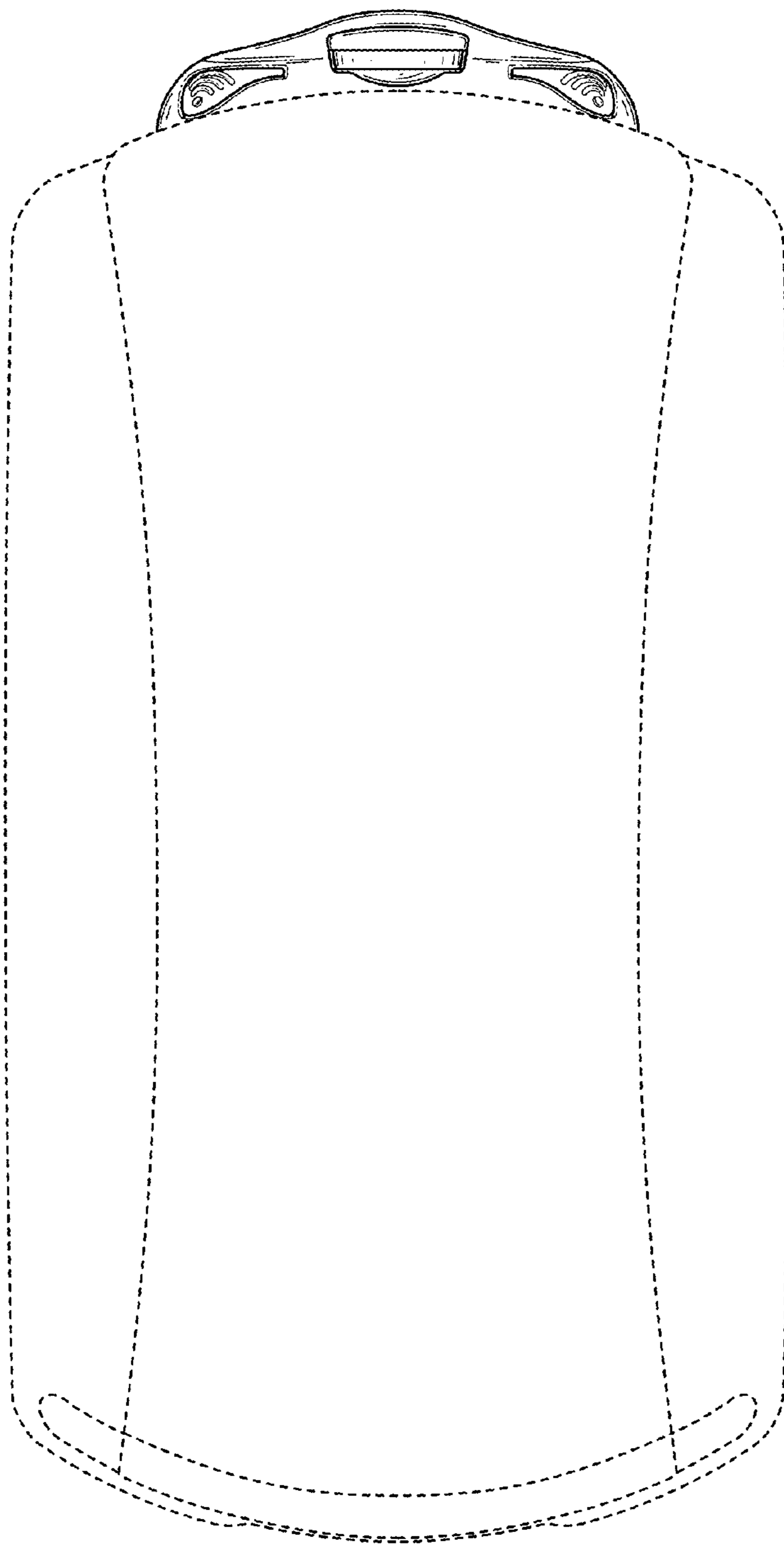

FIG. 2

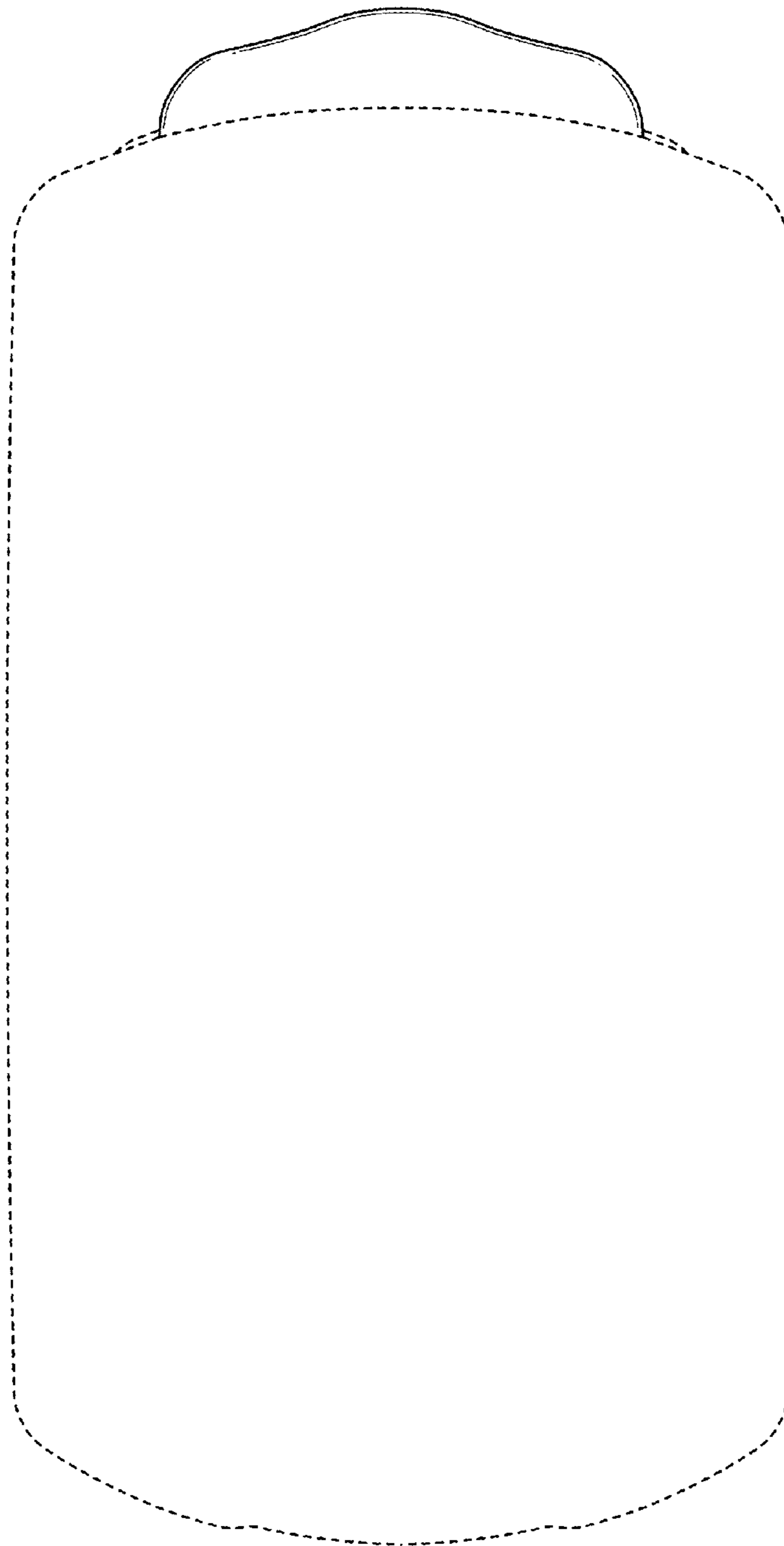

FIG. 3

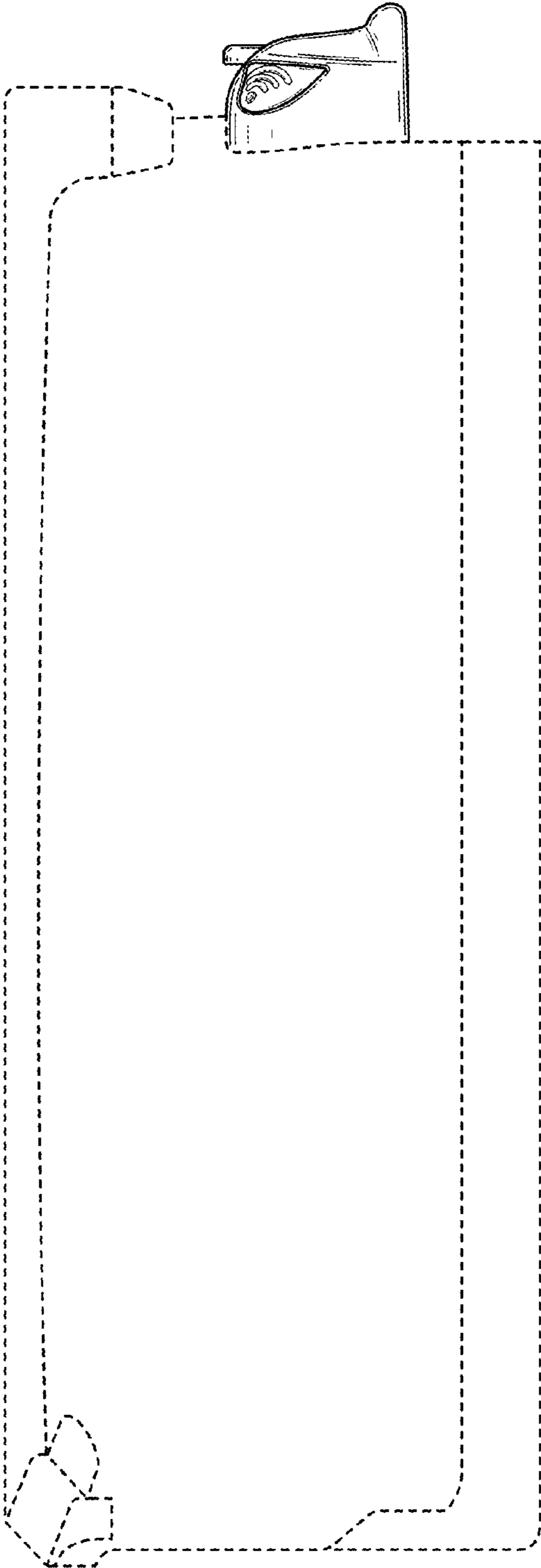

FIG. 4

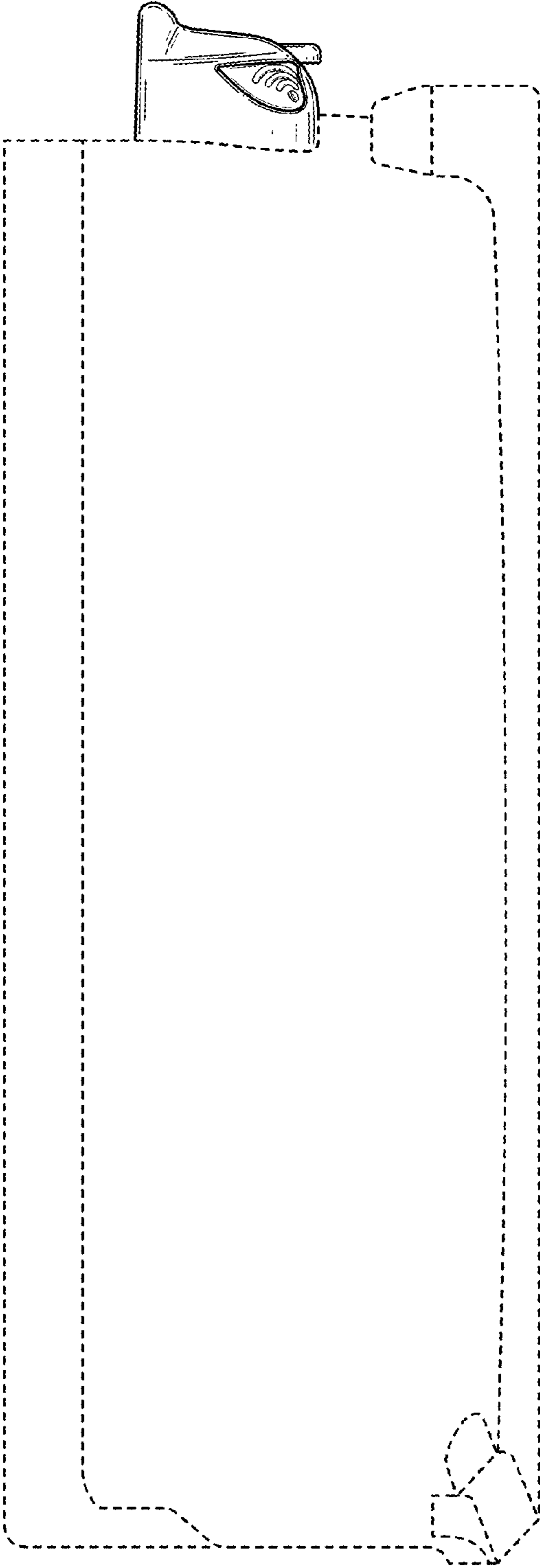

FIG. 5

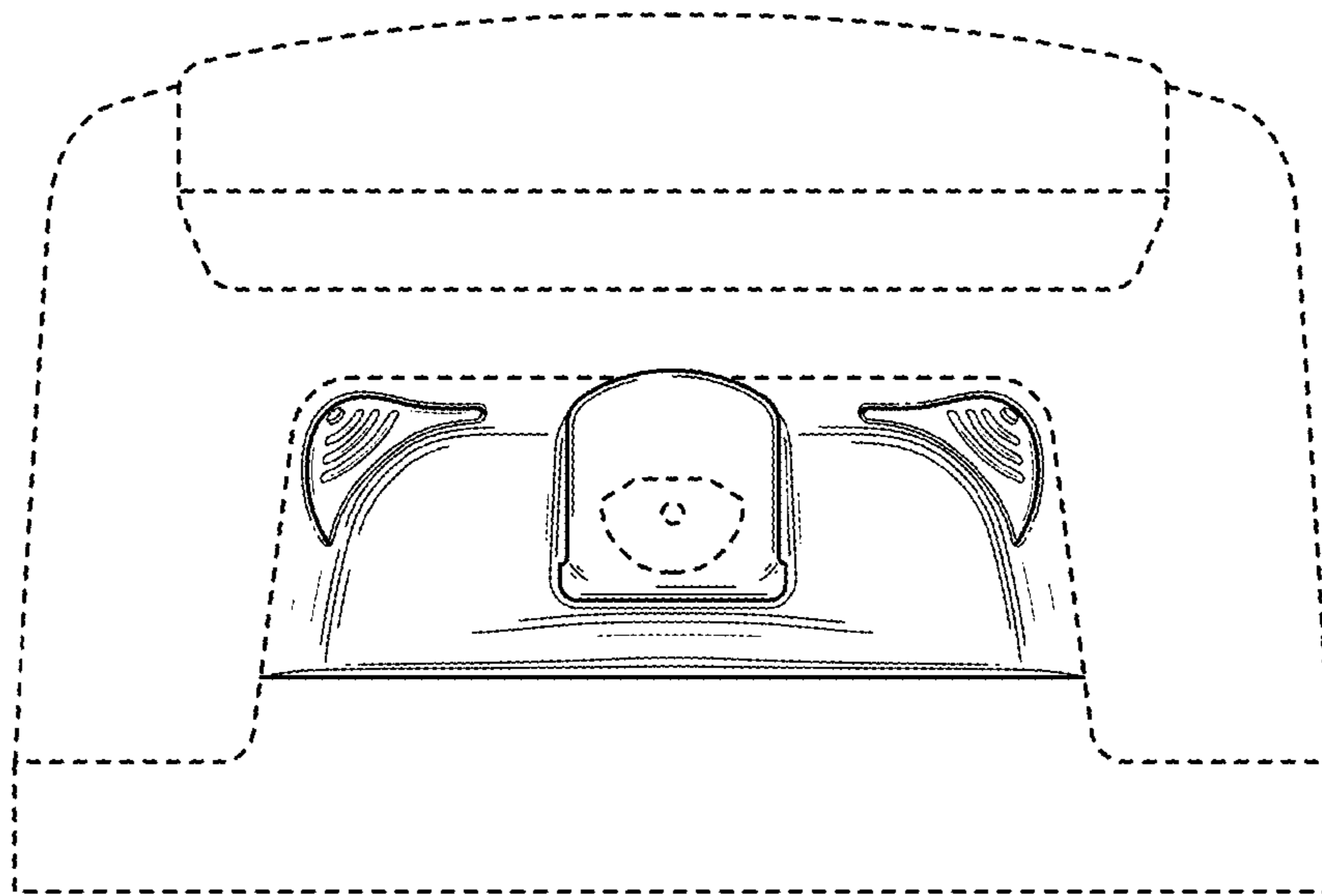

FIG. 6

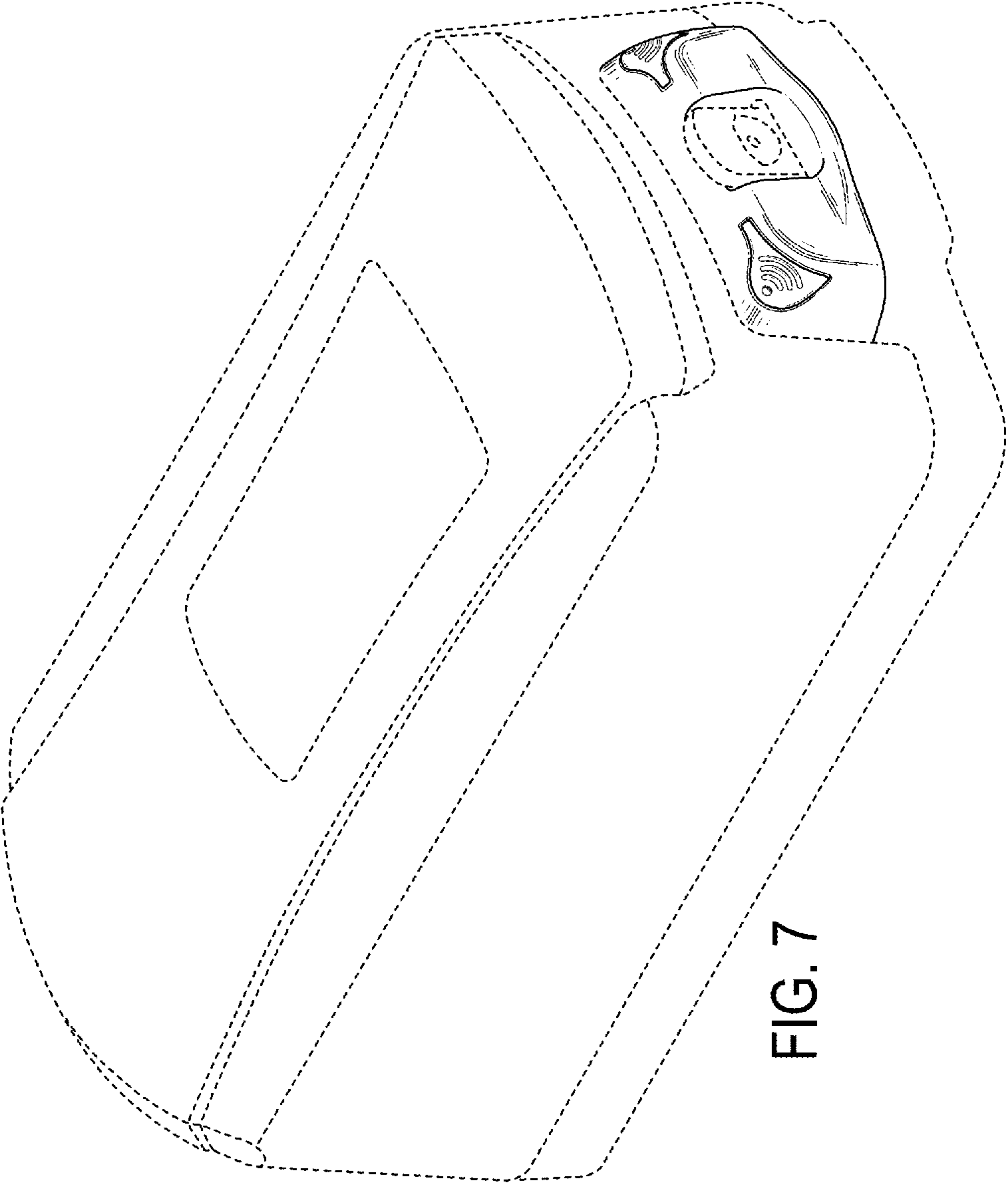

FIG. 7

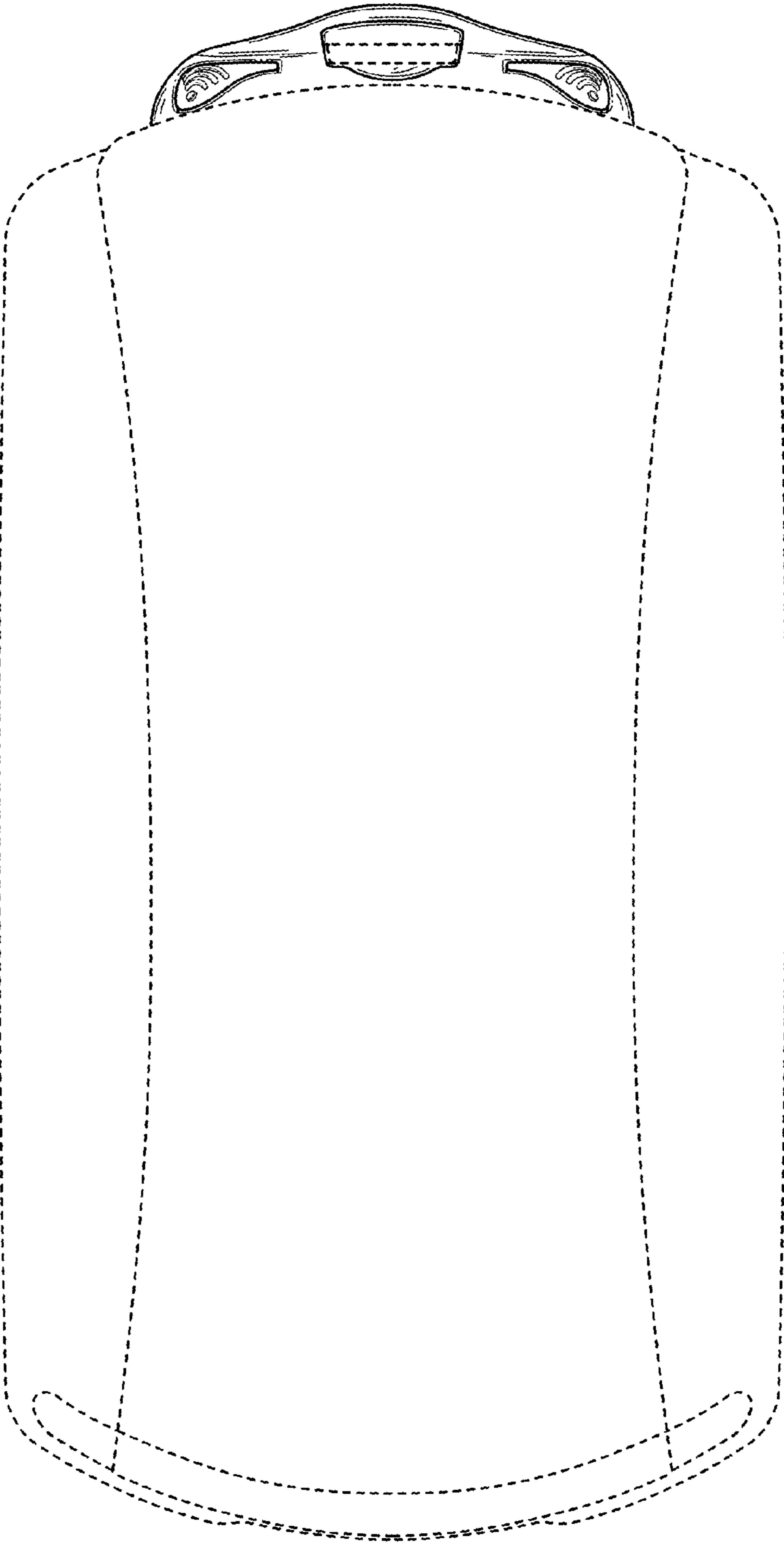

FIG. 8



FIG. 9

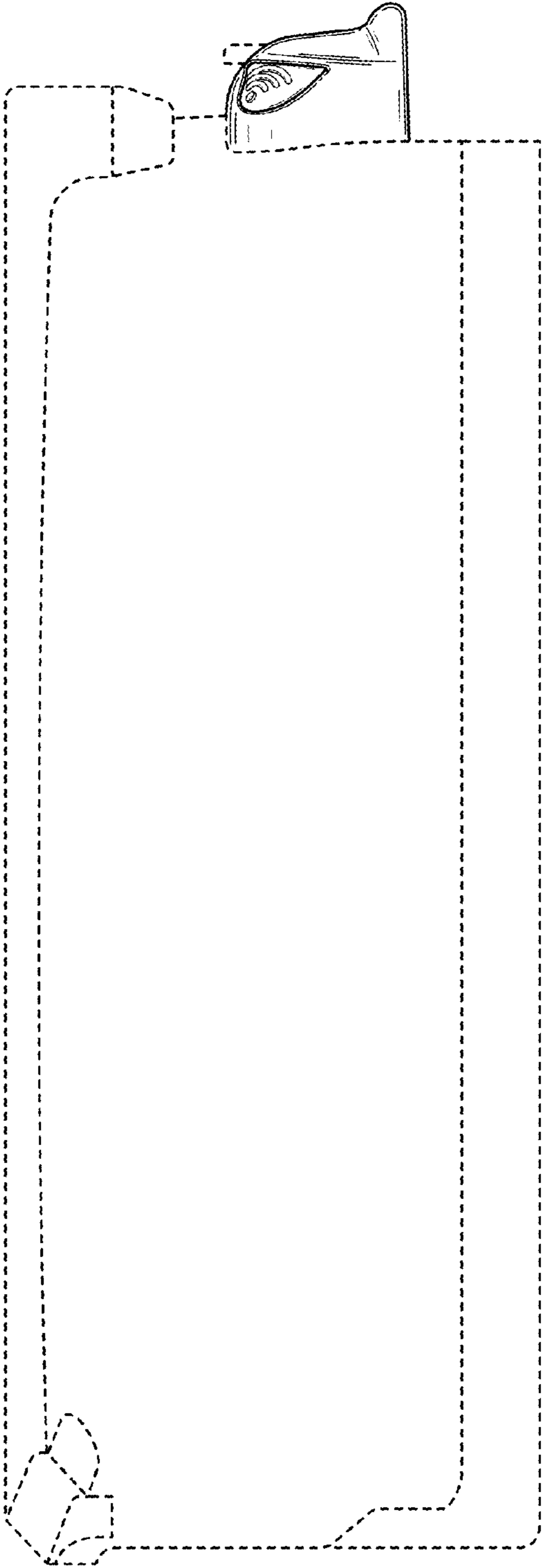

FIG. 10

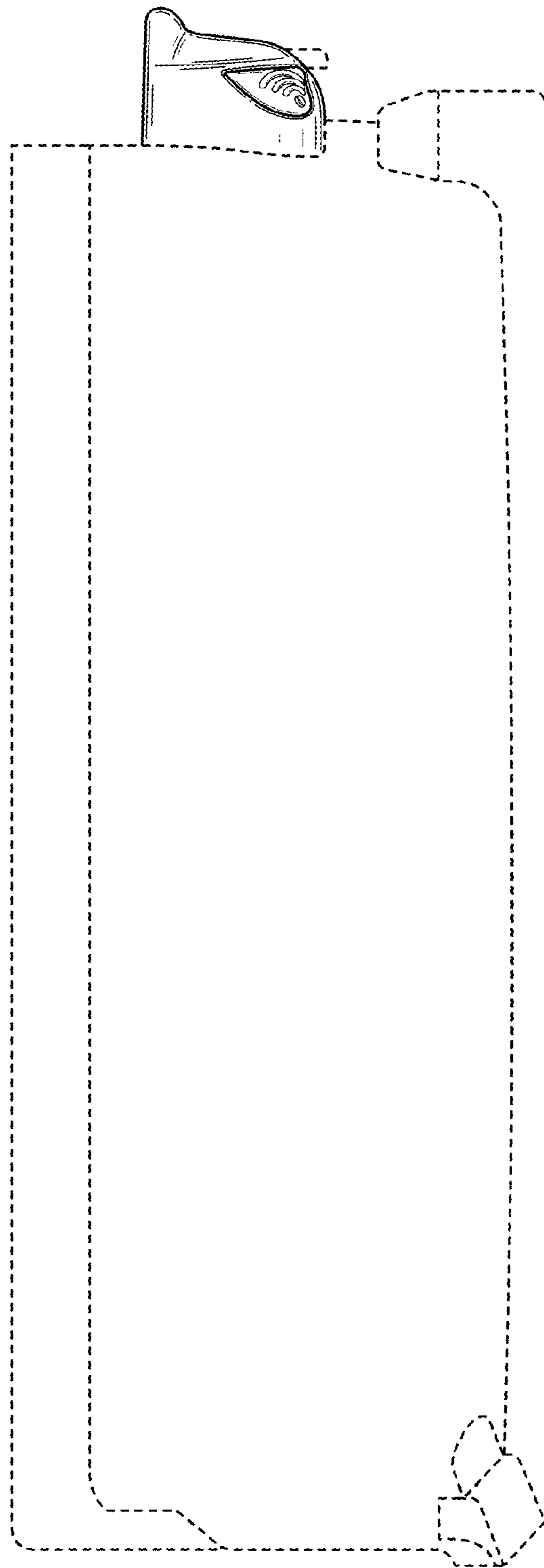

FIG. 11

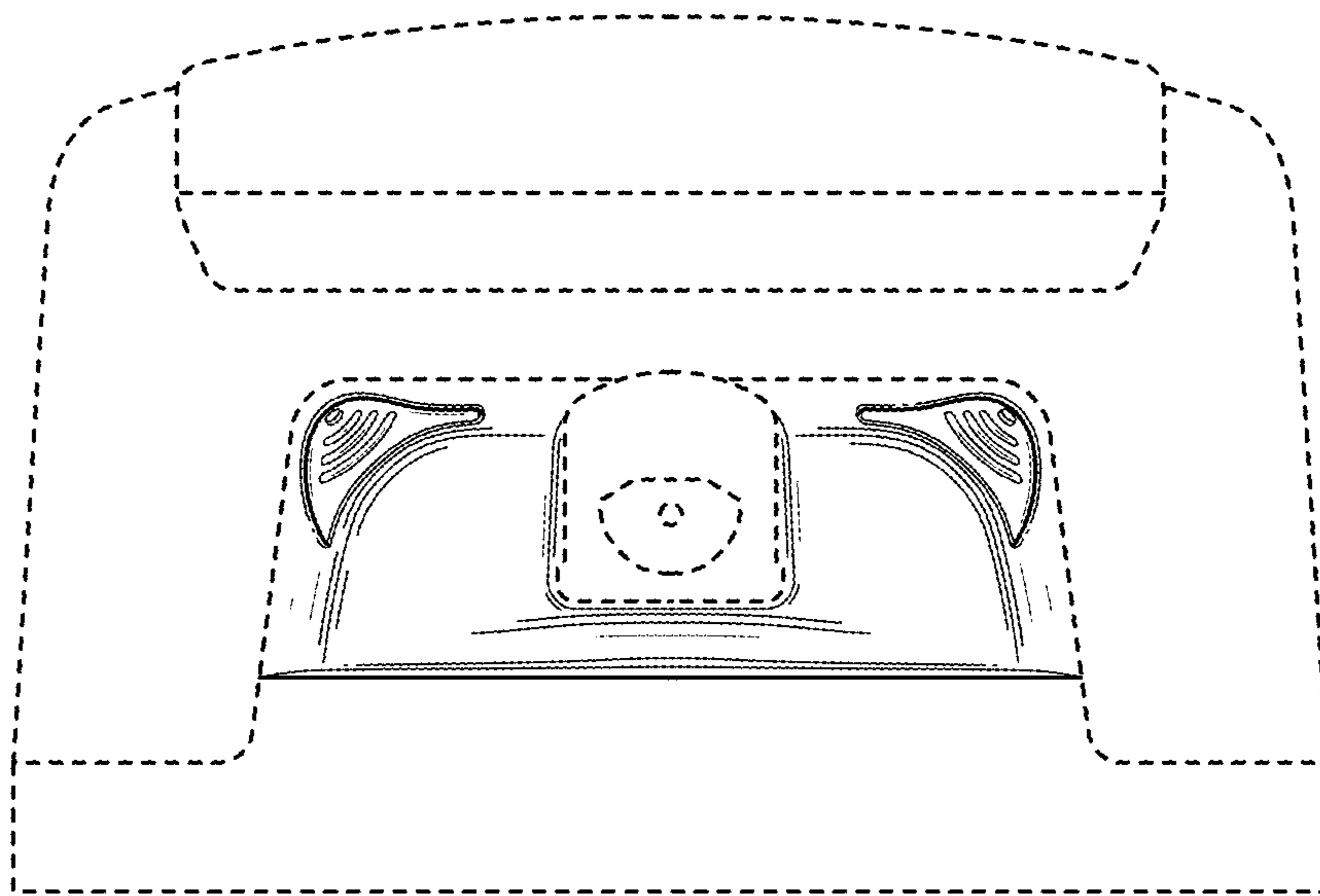

FIG. 12