



US00D725379S

(12) **United States Design Patent**
Dixon

(10) **Patent No.:** **US D725,379 S**
(45) **Date of Patent:** **** Mar. 31, 2015**

- (54) **MOBILE DEVICE CASE**
- (71) Applicant: **Desmond D'Keith Dixon**, Desoto, TX
(US)
- (72) Inventor: **Desmond D'Keith Dixon**, Desoto, TX
(US)
- (**) Term: **14 Years**
- (21) Appl. No.: **29/487,880**
- (22) Filed: **Apr. 14, 2014**
- (51) **LOC (10) Cl.** **03-01**
- (52) **U.S. Cl.**
USPC **D3/218**
- (58) **Field of Classification Search**
CPC A45F 5/00; A45F 5/02; A45F 5/021;
A45F 5/022; A45F 2005/00; A45F 2005/008;
A45F 2005/006; A45F 2005/02; A45F
2200/05; A45F 2200/0516
USPC D3/218-219, 215, 201, 224, 226, 228,
D3/269, 303; 224/240-241, 245, 578, 674,
224/676-681; 206/305, 320, 576, 759, 762;
455/575.1-575.8; D14/248, 250-251
See application file for complete search history.

- D551,847 S * 10/2007 Yeap et al. D3/201
- D551,855 S * 10/2007 Yeh et al. D3/218
- D697,305 S * 1/2014 Culver D3/218
- D705,534 S * 5/2014 Manjerico D3/218
- 8,737,044 B2 * 5/2014 Liu et al. 455/575.1

* cited by examiner

Primary Examiner — Catheri Oliver-Garcia

(57) **CLAIM**
The ornamental design for a mobile device case, as shown and described.

DESCRIPTION

FIG. 1 is a perspective front view of a mobile device case, shown hanging from a chain;
 FIG. 2 is a front elevation view of the mobile device case;
 FIG. 3 is a rear elevation view of the mobile device case;
 FIG. 4 is a left side elevation view of the mobile device case, shown with a hand grip, right side elevation view being a mirror image thereof;
 FIG. 5 is a top plan view of the mobile device case, shown with the hand grip; and,
 FIG. 6 is a bottom plan view of the mobile device case, shown with the hand grip.
 The chain and hand grip are shown in broken lines for illustrative purposes only and form no part of the claimed design.

- (56) **References Cited**
U.S. PATENT DOCUMENTS
D542,028 S * 5/2007 Yang et al. D3/218

1 Claim, 3 Drawing Sheets

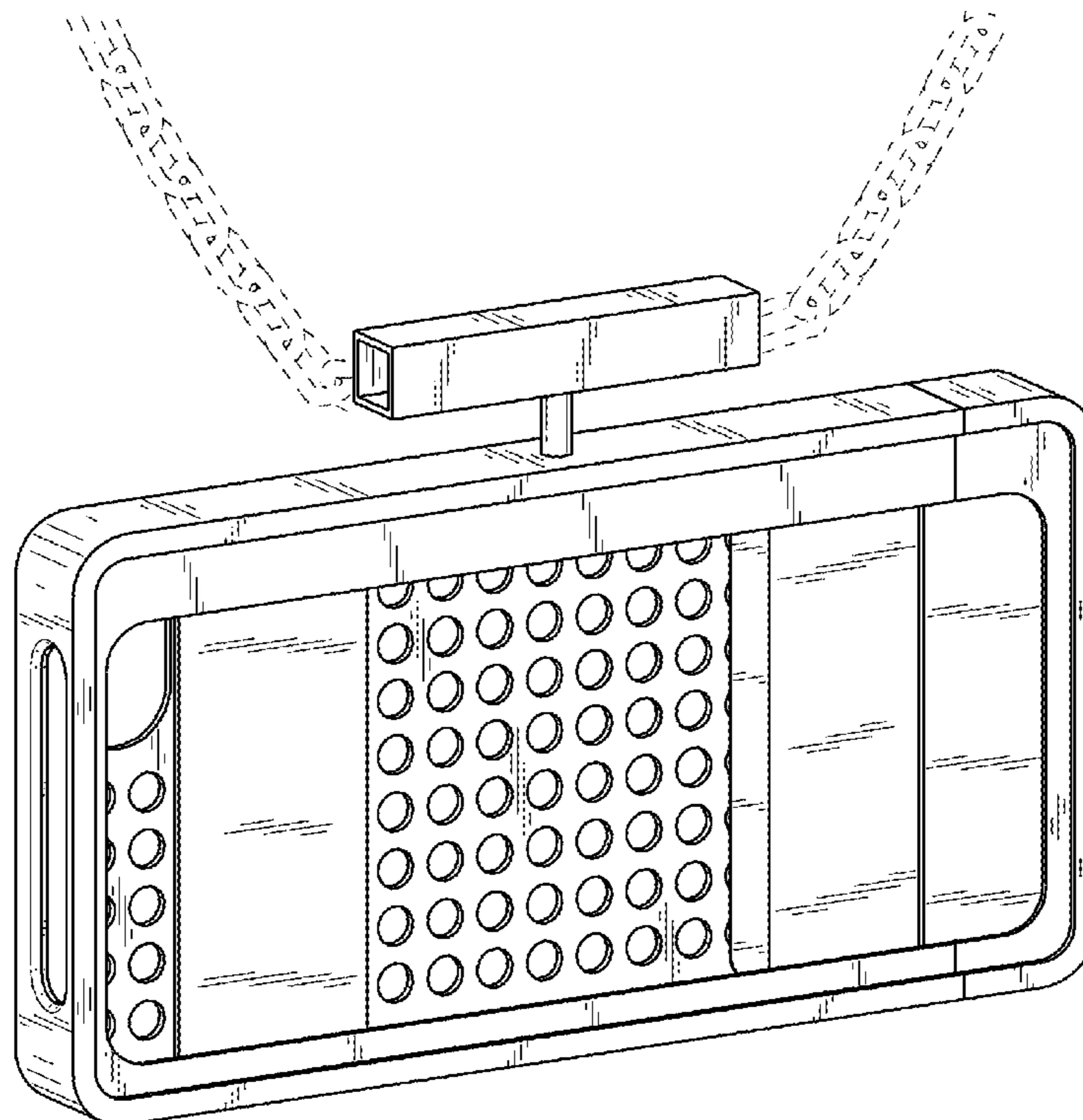

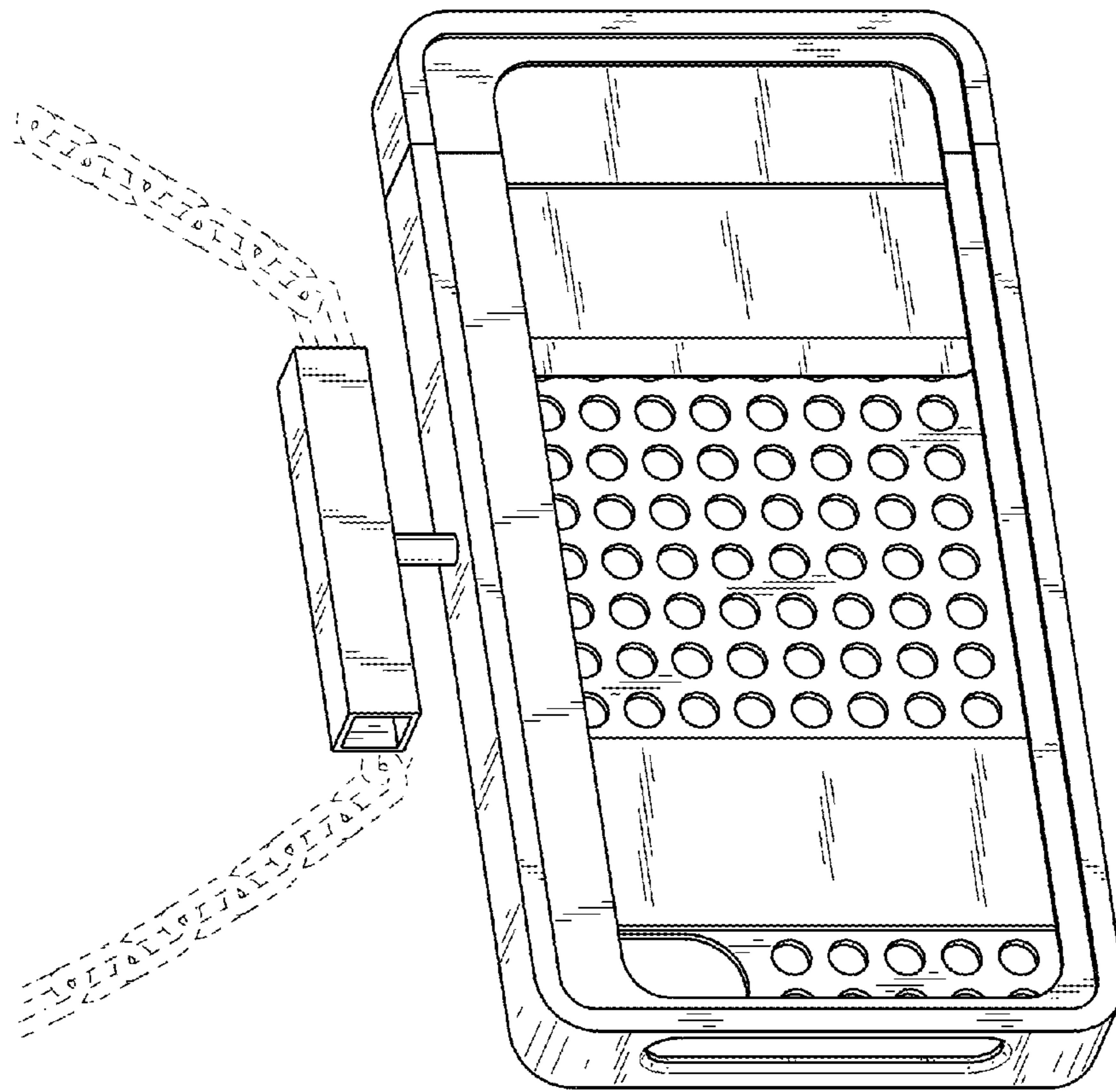

FIG. 1

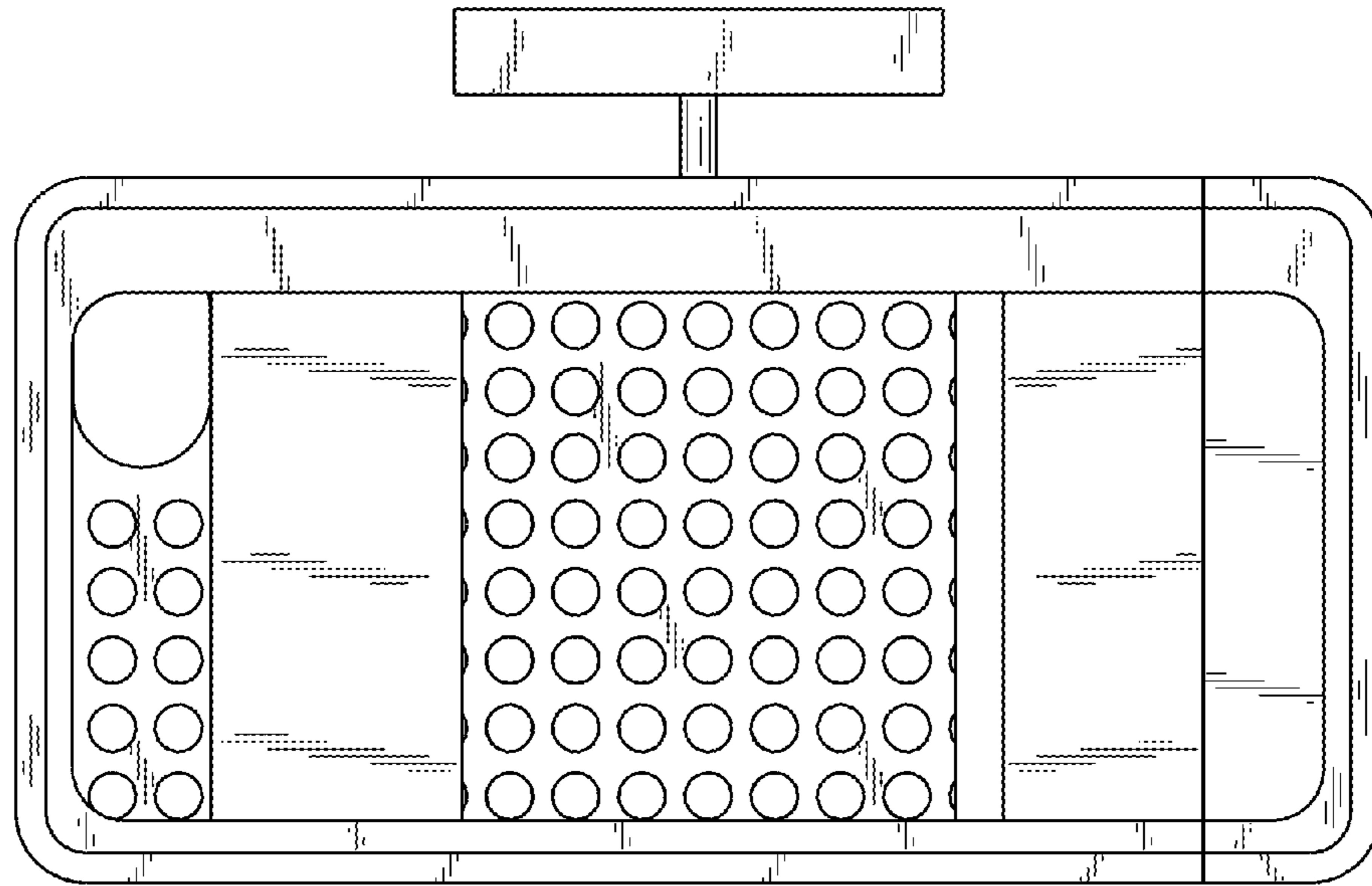

FIG. 2

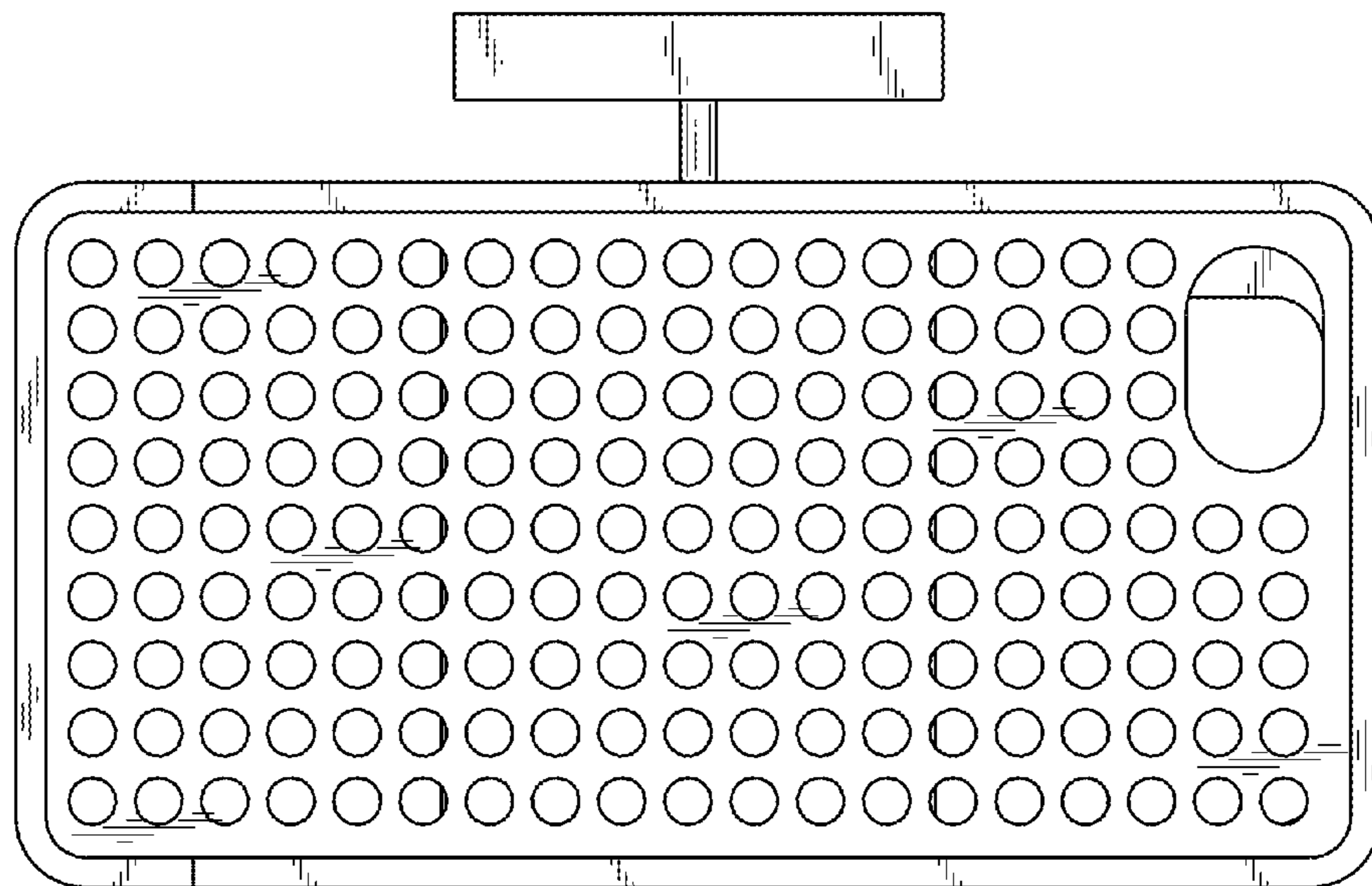

FIG. 3

FIG. 4

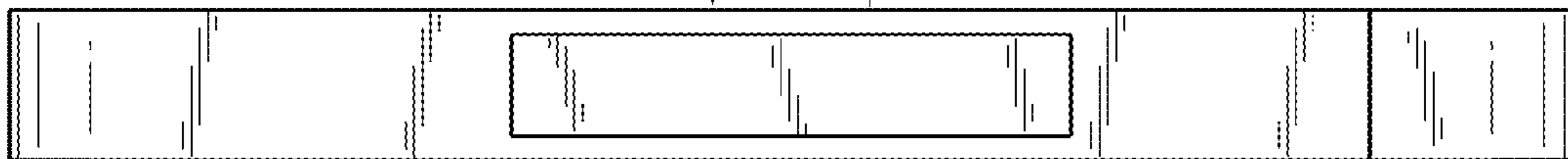
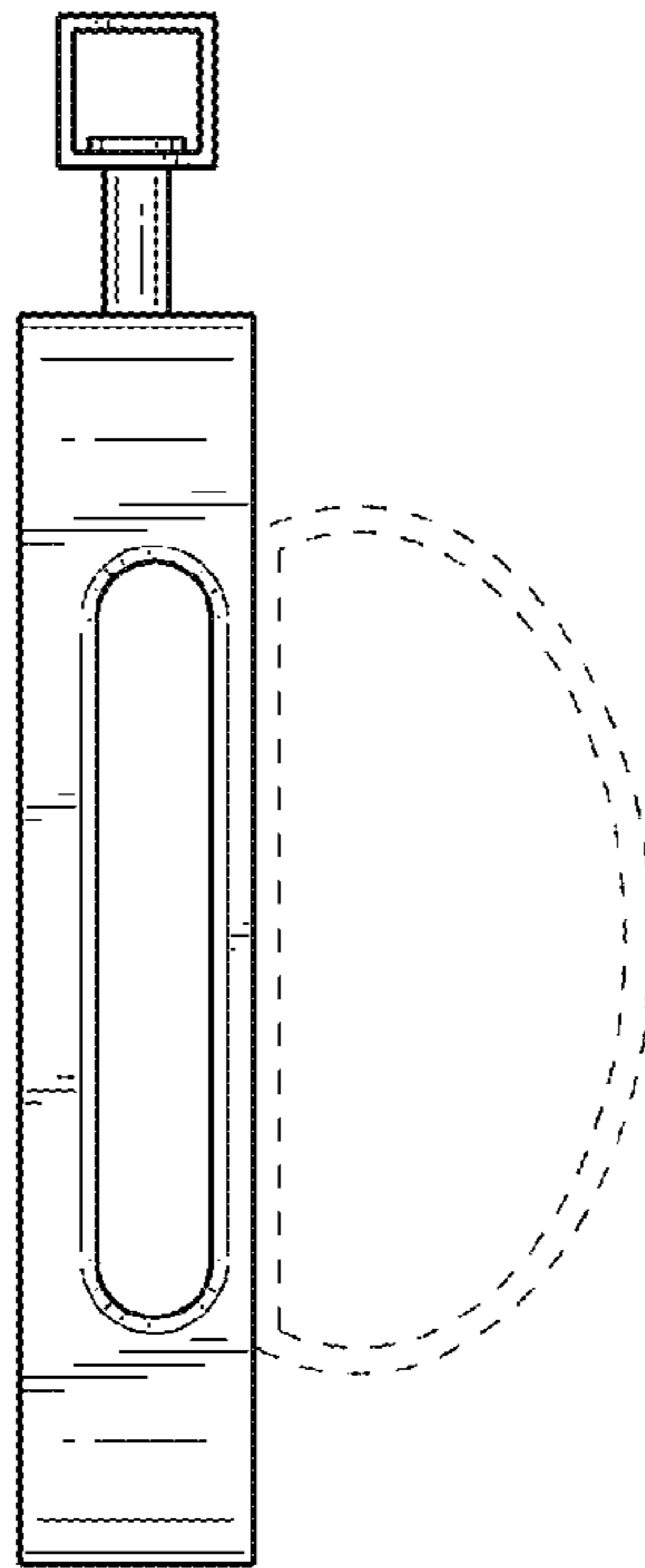

FIG. 5

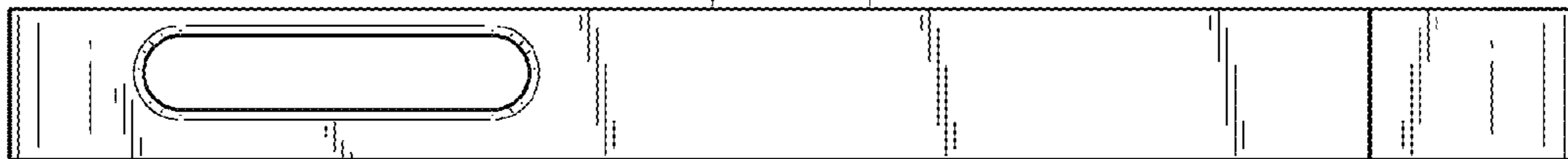

FIG. 6