



US00D725351S

(12) **United States Design Patent**
Tref

(10) **Patent No.:** **US D725,351 S**
(45) **Date of Patent:** **** Mar. 31, 2015**

(54) **SANDAL WITH HEEL**
(71) Applicant: **Fabien Tref**, Naples, FL (US)
(72) Inventor: **Fabien Tref**, Naples, FL (US)
(**) Term: **14 Years**
(21) Appl. No.: **29/488,617**
(22) Filed: **Apr. 22, 2014**
(51) **LOC (10) CI.** **02-04**
(52) **U.S. Cl.**
USPC **D2/918**
(58) **Field of Classification Search**
USPC D2/896, 916-918, 946, 969, 971;
36/83, 112, 113, 136, 3 A, 7.4, 7.5, 7.6,
36/11.5, 45
See application file for complete search history.

2012/0279083 A1 11/2012 Maselko
2013/0025162 A1 1/2013 Osiol
2013/0047468 A1 2/2013 Everett-Weber
2014/0007460 A1 1/2014 White

FOREIGN PATENT DOCUMENTS

CN 202941504 5/2013
WO 2012079646 6/2012

OTHER PUBLICATIONS

http://www.amazon.com/Soda-Womens-Sequined-Thong-Sandals/dp/B00CUQRB4K/ref=sr_1_3?ie=UTF8&qid=1398111422&sr=8-3&keywords=soda+tyra+sandal; Apr. 21, 2014, Amazon.com.
http://www.amazon.com/BETANI-Womens-beach-style-triangle/dp/B00BJGPGBW/ref=sr_1_2?ie=UTF8&qid=1398111525&sr=8-2&keywords=betani+eva+sandal; Apr. 21, 2014, Amazon.com.
http://www.amazon.com/Casual-Spring-Summer-Antiskid-Beach/dp/B00BIYADTA/ref=sr_1_26?ie=UTF8&qid=1398111668&sr=8-26&keywords=thick+sole+beach+sandals; Apr. 21, 2014, Amazon.com.
http://www.amazon.com/Skechers-Womens-Pinup2-Stud-Wedge-Sandal/dp/BooDQOO4R2/ref=sr_1_fkmr0_1?ie=UTF8&qid=1398111766&sr=8-1-fkmr0&keywords=skechers+women%27s+pinup+stud; Apr. 21, 2014.

(56) **References Cited**

U.S. PATENT DOCUMENTS

2,724,912 A 11/1955 Silombra
4,069,601 A * 1/1978 Robbins et al. 36/11.5
D247,657 S * 4/1978 York, Jr. D2/917
D260,570 S * 9/1981 Wong D2/917
D278,946 S * 5/1985 Chen D2/917
D333,904 S * 3/1993 Eminger D2/917
D450,178 S * 11/2001 Boncutter D2/917
D495,123 S 8/2004 Wakatake
6,769,204 B1 8/2004 Phillips
D511,241 S * 11/2005 Cobian D2/917
D542,512 S 5/2007 Krutilek
D545,034 S * 6/2007 Amado et al. D2/946
D592,840 S * 5/2009 Vasyli D2/917
D602,233 S * 10/2009 Feller et al. D2/917
D602,234 S * 10/2009 Feller D2/917
D603,588 S * 11/2009 McClaskie D2/950
D605,387 S 12/2009 Talenga
D640,451 S 6/2011 Chang
D643,188 S 8/2011 Tonkel
D647,289 S 10/2011 Schwinger
D656,716 S 4/2012 Eades
D688,852 S * 9/2013 Garvie et al. D2/918
2003/0200675 A1 10/2003 Gross
2008/0168682 A1 7/2008 Le
2012/0186109 A1 7/2012 Vanderbeck

* cited by examiner

Primary Examiner — Ian Simmons
Assistant Examiner — Rashida C McCoy
(74) *Attorney, Agent, or Firm* — Mark Terry

(57) **CLAIM**

The ornamental design for a sandal with heel, as shown and described.

DESCRIPTION

FIG. 1 is a front perspective view of a sandal with heel, showing the new design;
FIG. 2 is a rear perspective view thereof;
FIG. 3 is a left side view thereof;
FIG. 4 is a right side view of thereof;
FIG. 5 is a front view thereof;
FIG. 6 is a rear view thereof;
FIG. 7 is a top view thereof; and,
FIG. 8 is a bottom view thereof.
The broken lines shown in the drawings represent unclaimed environment and form no part of the claim.

1 Claim, 3 Drawing Sheets

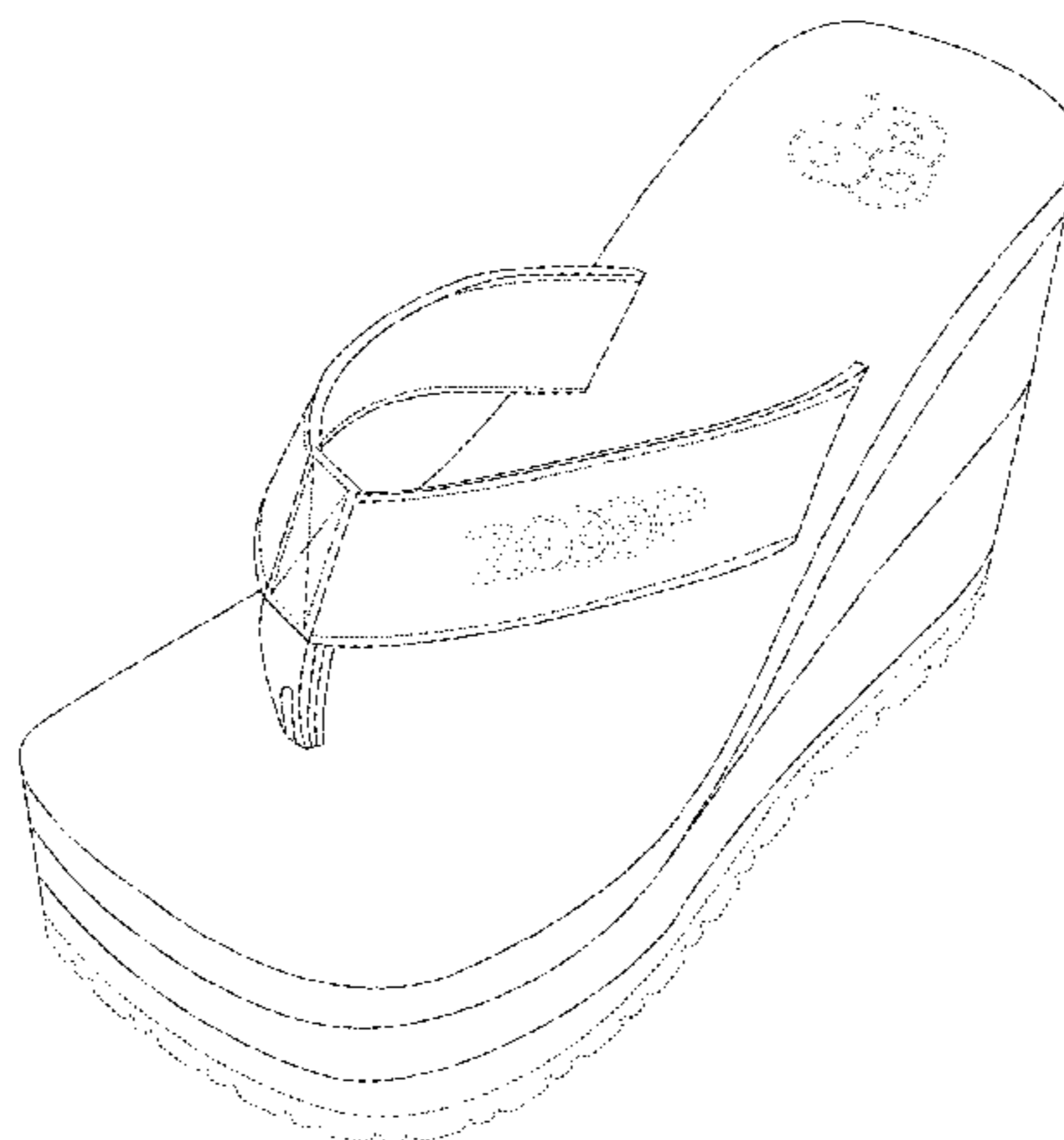

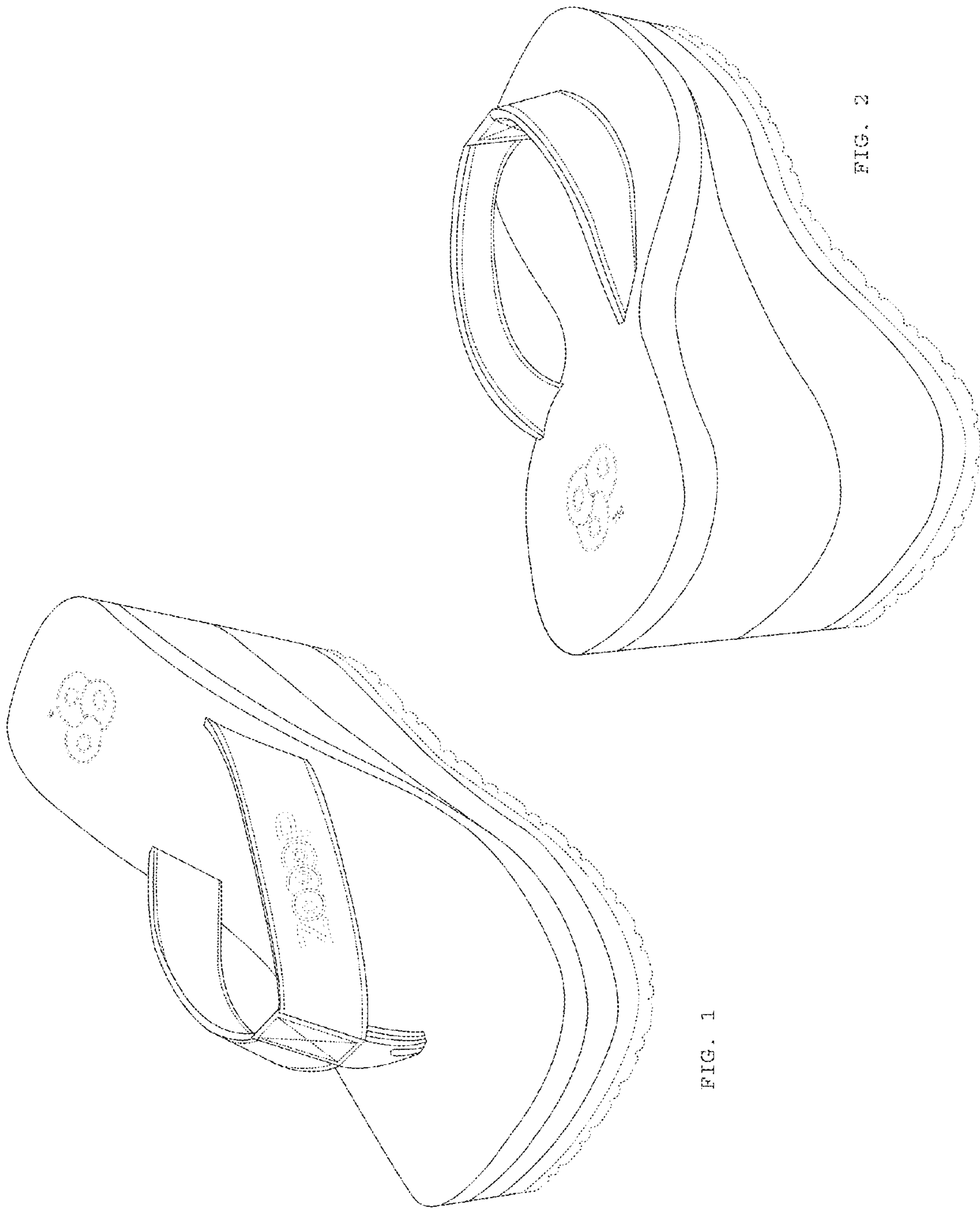

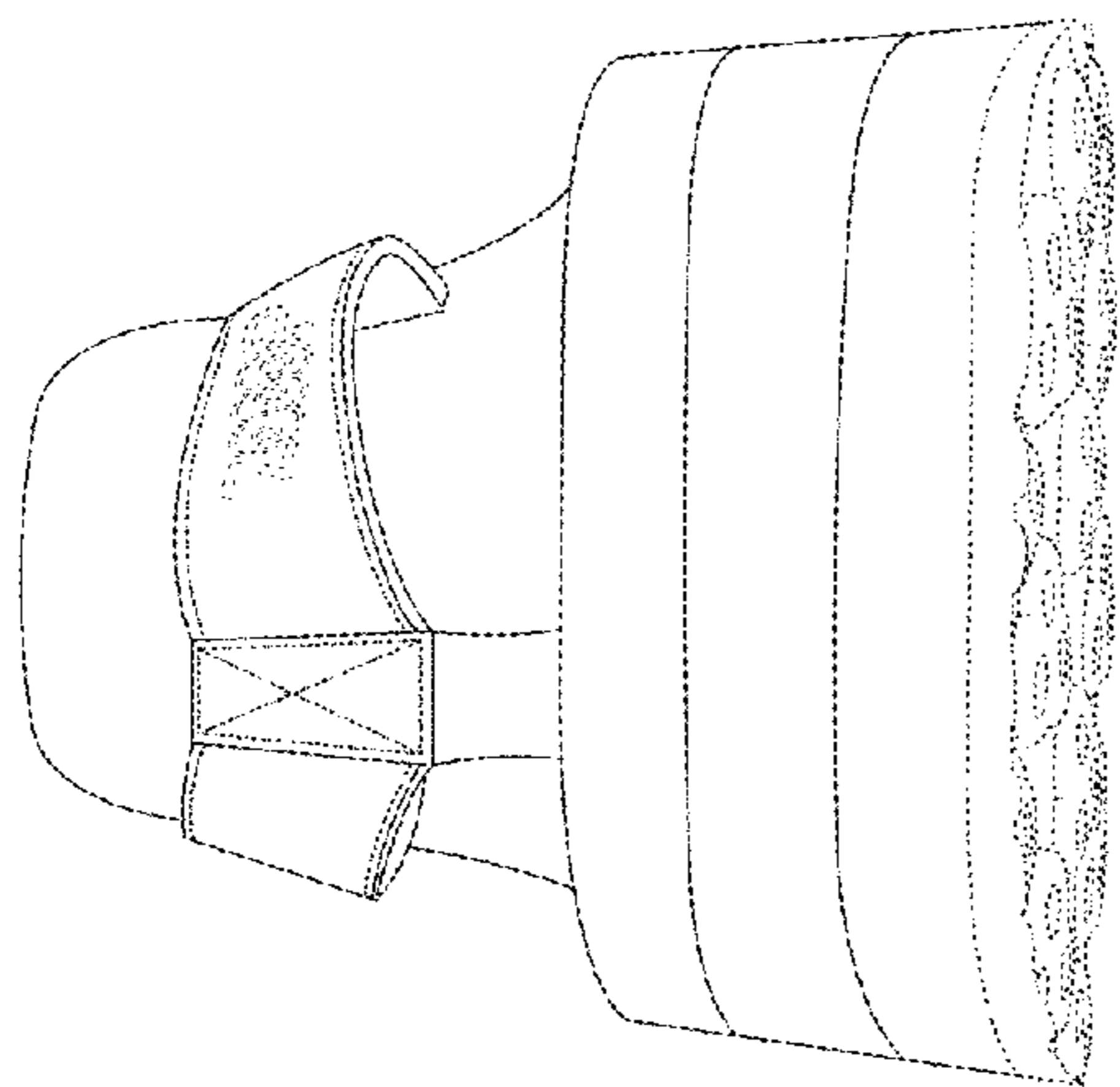

FIG. 5

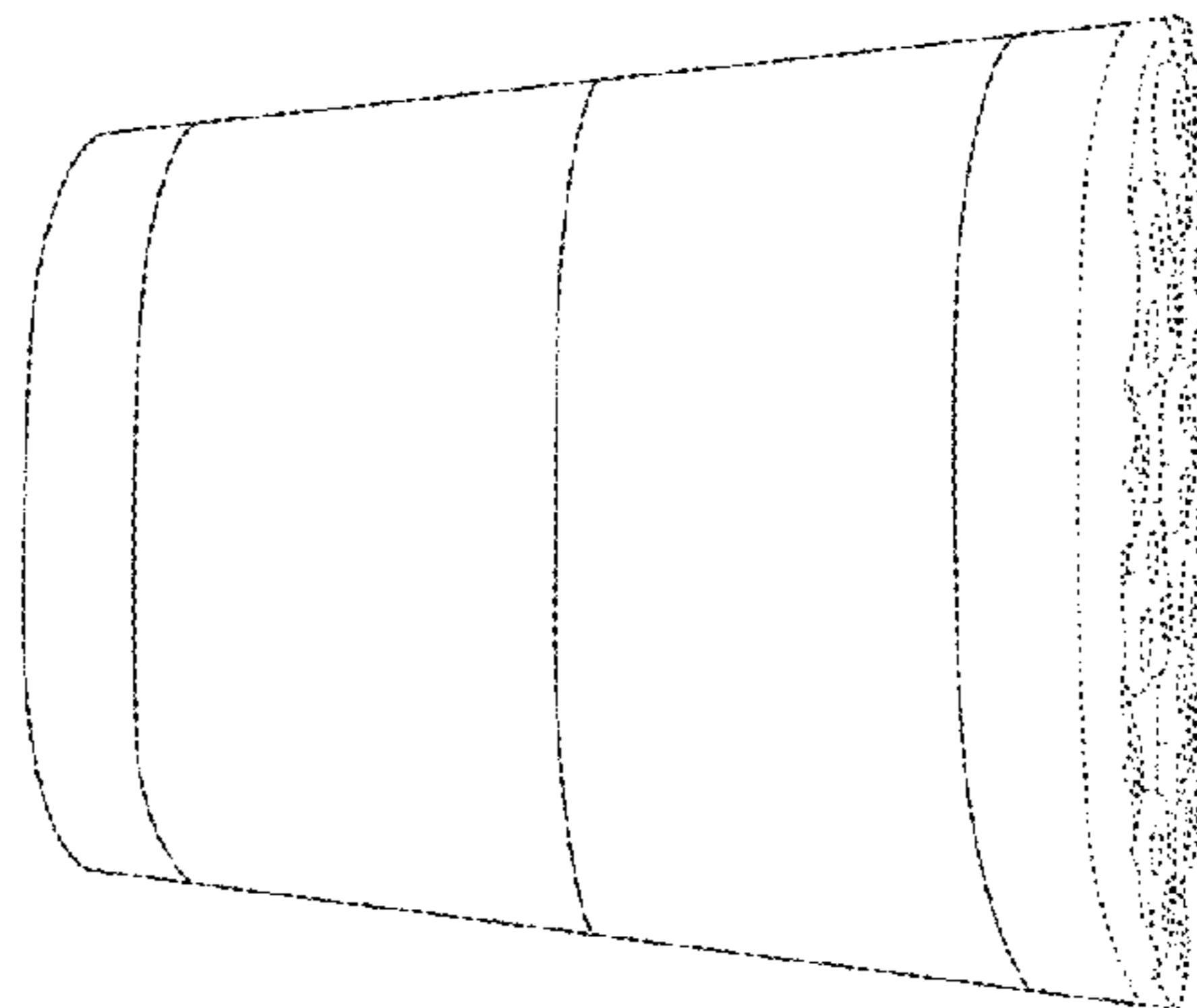

FIG. 6

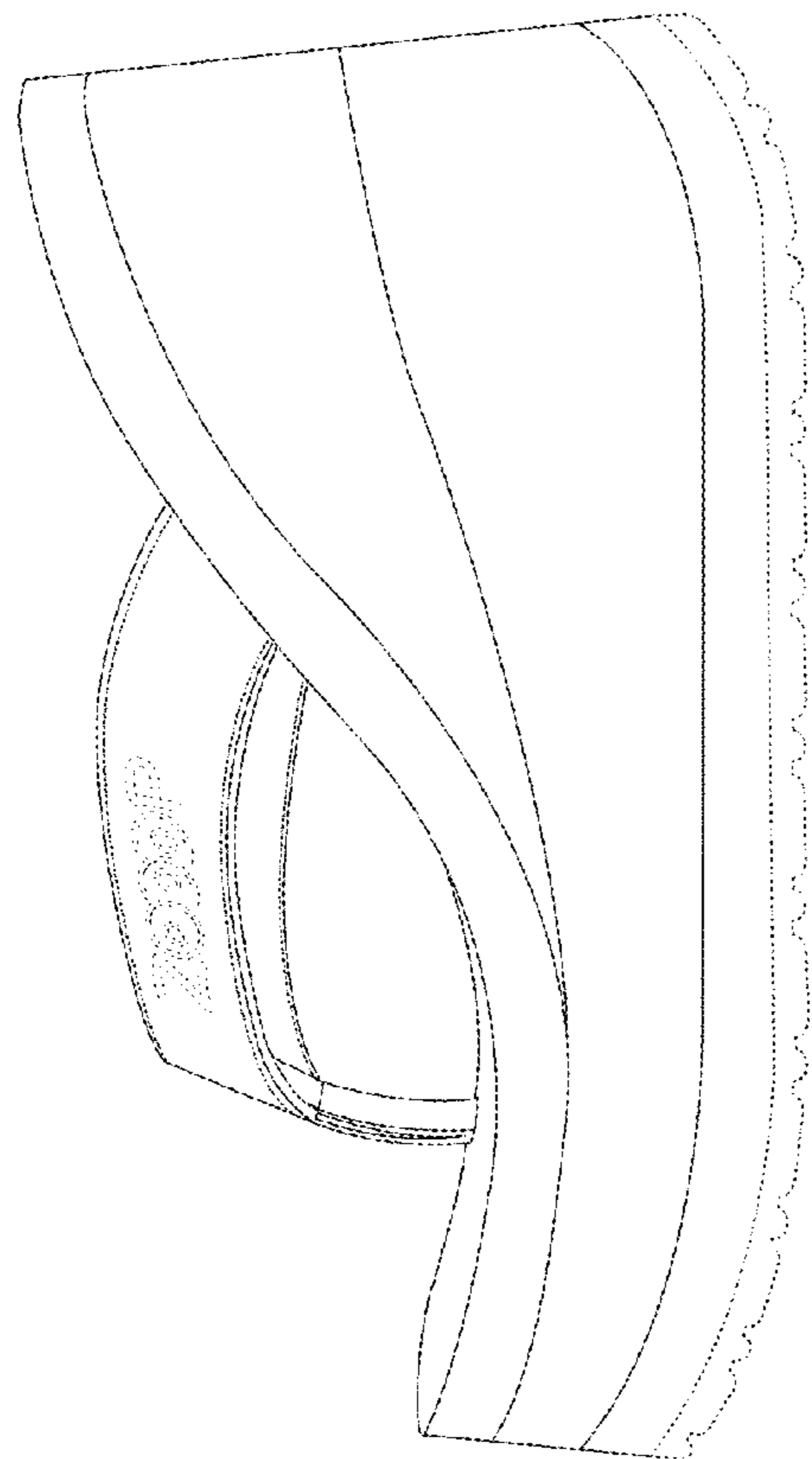

FIG. 3

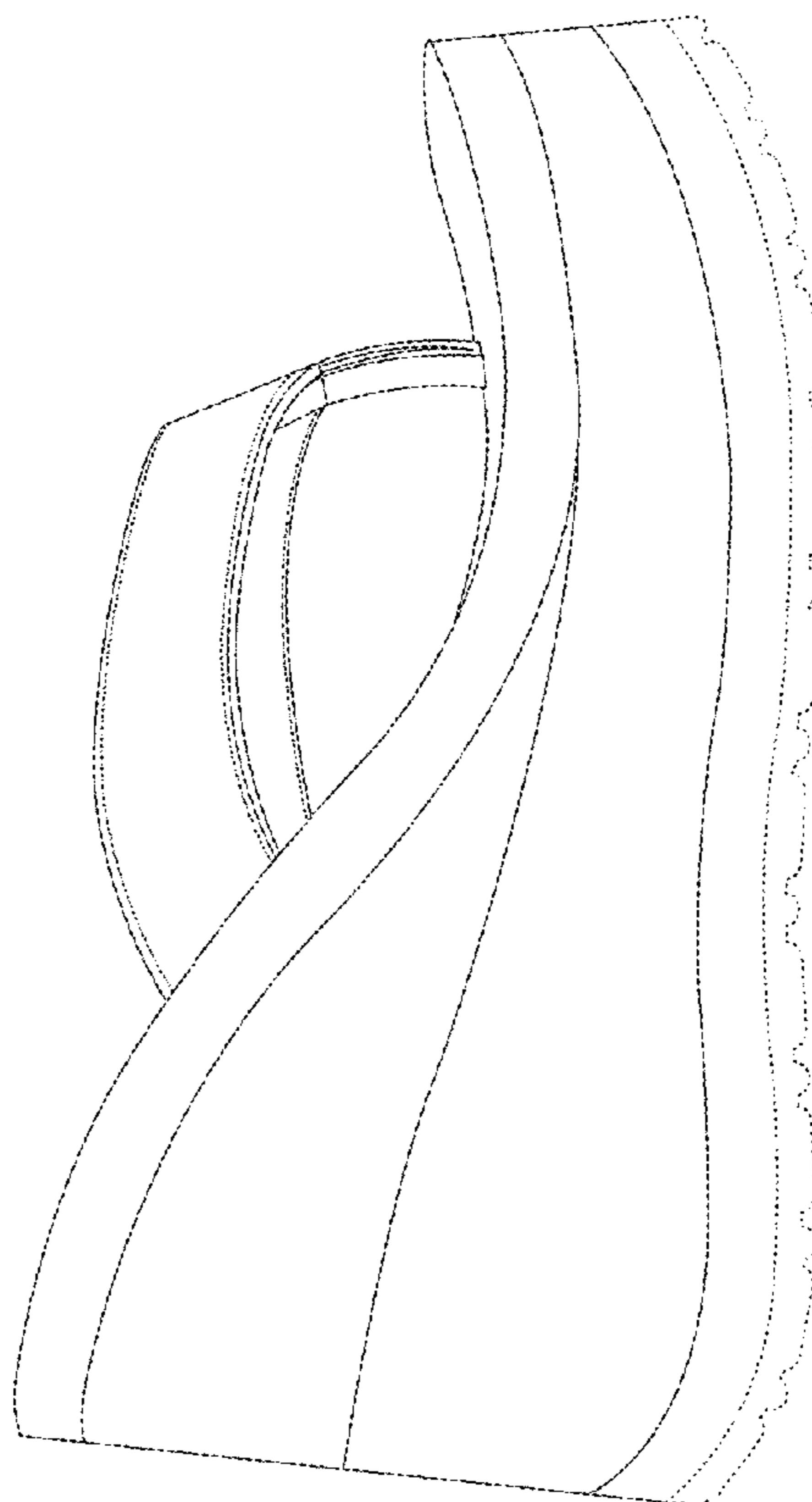

FIG. 4

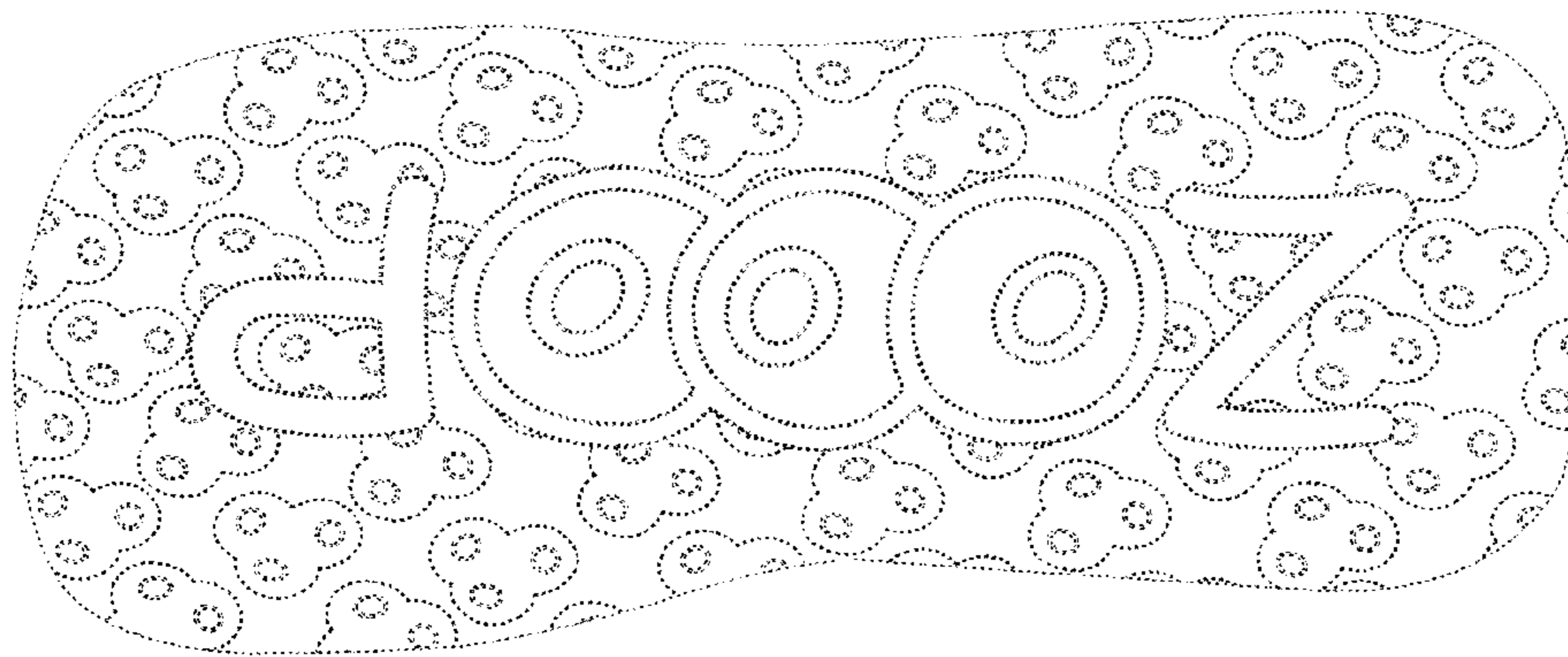

FIG. 8

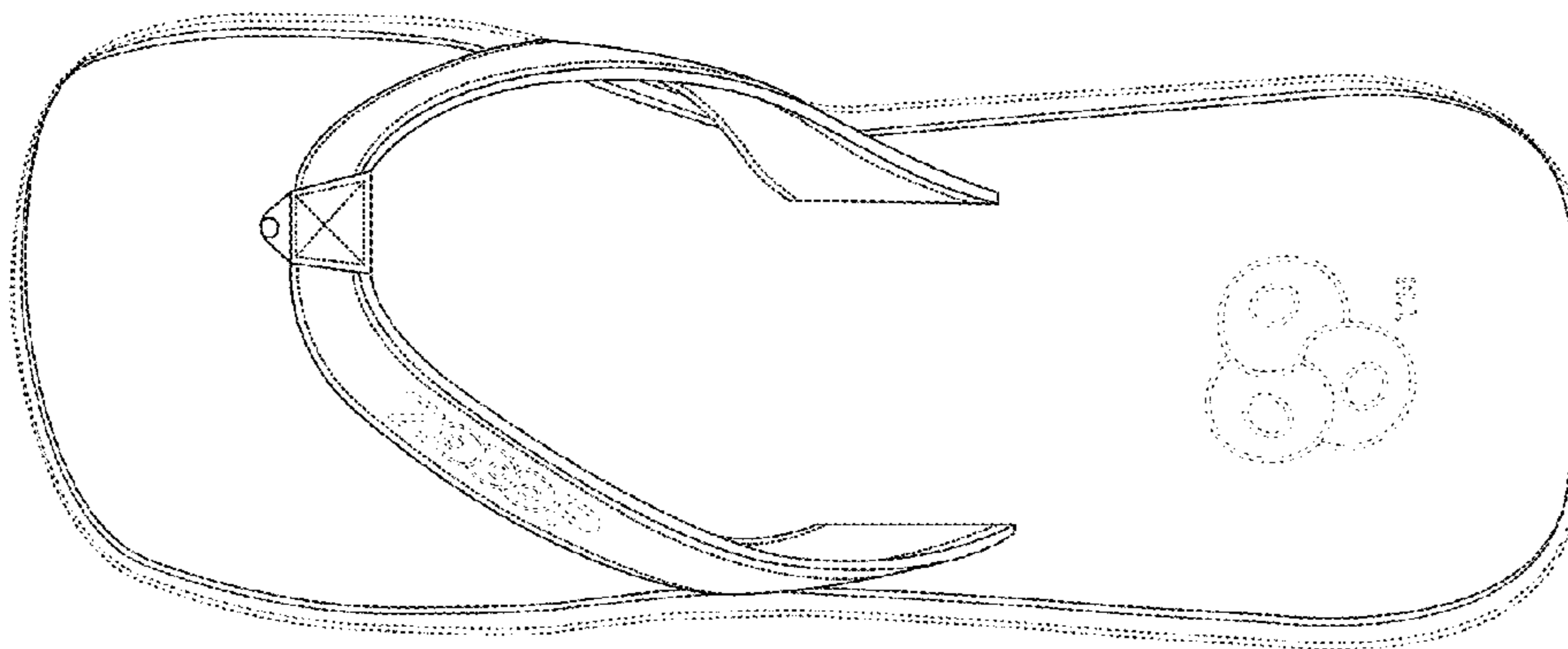

FIG. 7