



US00D725272S

(12) **United States Design Patent**
Marteau

(10) **Patent No.:** **US D725,272 S**
(45) **Date of Patent:** **** Mar. 24, 2015**

(54) **MEDICAL IMAGING SYSTEM**

(75) Inventor: **Jean-Michel Marteau**, Le Plessis-Robinson (FR)

(73) Assignee: **General Electric Company**, Schenectady, NY (US)

(**) Term: **14 Years**

(21) Appl. No.: **29/407,222**

(22) Filed: **Nov. 23, 2011**

(51) **LOC (10) Cl.** **24-01**

(52) **U.S. Cl.**
USPC **D24/158**

(58) **Field of Classification Search**
USPC D24/158-161, 186, 202, 209, 210;
378/4, 15, 17, 20, 21, 23-27, 62, 68,
378/146, 195, 198, 208, 209; 396/1.2;
600/1

See application file for complete search history.

(56) **References Cited**

U.S. PATENT DOCUMENTS

D553,748	S	*	10/2007	Ogiwara	D24/158
D648,028	S	*	11/2011	Yokoyama et al.	D24/158
D658,762	S	*	5/2012	Yokoyama et al.	D24/158
2010/0027761	A1	*	2/2010	Fadler et al.	378/198
2010/0296632	A1	*	11/2010	Bouvier	378/198
2011/0002444	A1	*	1/2011	Schmitt et al.	378/62
2011/0058656	A1	*	3/2011	Hartwich et al.	378/198
2011/0164721	A1	*	7/2011	Jank et al.	378/4
2011/0243309	A1	*	10/2011	Weijiang	378/197
2011/0268248	A1	*	11/2011	Simon et al.	378/62
2012/0155616	A1	*	6/2012	Rijken et al.	378/198

* cited by examiner

Primary Examiner — T. Chase Nelson
Assistant Examiner — Ania Aman

(74) *Attorney, Agent, or Firm* — The Small Patent Law Group LLC; Dean Small

(57) **CLAIM**

The ornamental design of a medical imaging system, as shown and described.

DESCRIPTION

FIG. 1 is a front perspective view of a medical imaging system in first operational configuration showing our new design; FIG. 2 is a side perspective view of the medical imaging system shown in FIG. 1; FIG. 3 is a rear perspective view of the medical imaging system shown in FIG. 1; FIG. 4 is another rear perspective view of the medical imaging system shown in FIG. 1; FIG. 5 is a rear view of the medical imaging system shown in FIG. 1; FIG. 6 is a side view of the medical imaging system shown in FIG. 1; FIG. 7 is a front view of the medical imaging system shown in FIG. 1; FIG. 8 is another front view of the medical imaging system shown in FIG. 1; FIG. 9 is a rear perspective view of a portion of the medical imaging system shown in FIG. 1; FIG. 10 is another front perspective view of another portion of the medical imaging system shown in FIG. 1; FIG. 11 is another front perspective view of still another portion of the medical imaging system shown in FIG. 1; FIG. 12 is a side perspective view of a medical imaging system shown in FIG. 1 in a second operational configuration; FIG. 13 is a side perspective view of a medical imaging system shown in FIG. 1 in a second operational configuration; and, FIG. 14 is a side perspective view of a medical imaging system shown in FIG. 1 in a second operational configuration. The broken lines shown in the drawings are for the purpose of illustrating portions of the article and form no part of the claimed design.

1 Claim, 14 Drawing Sheets

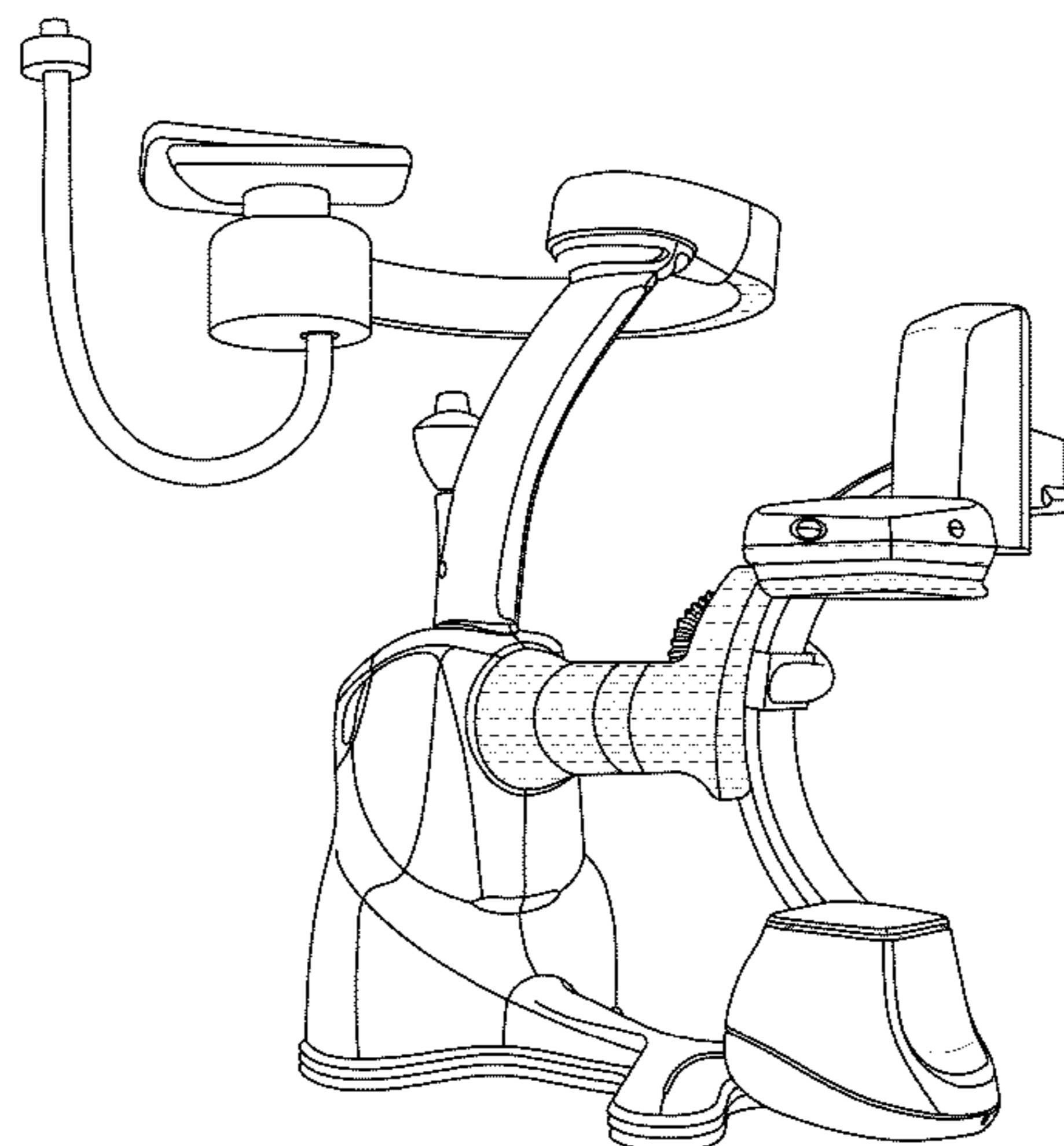

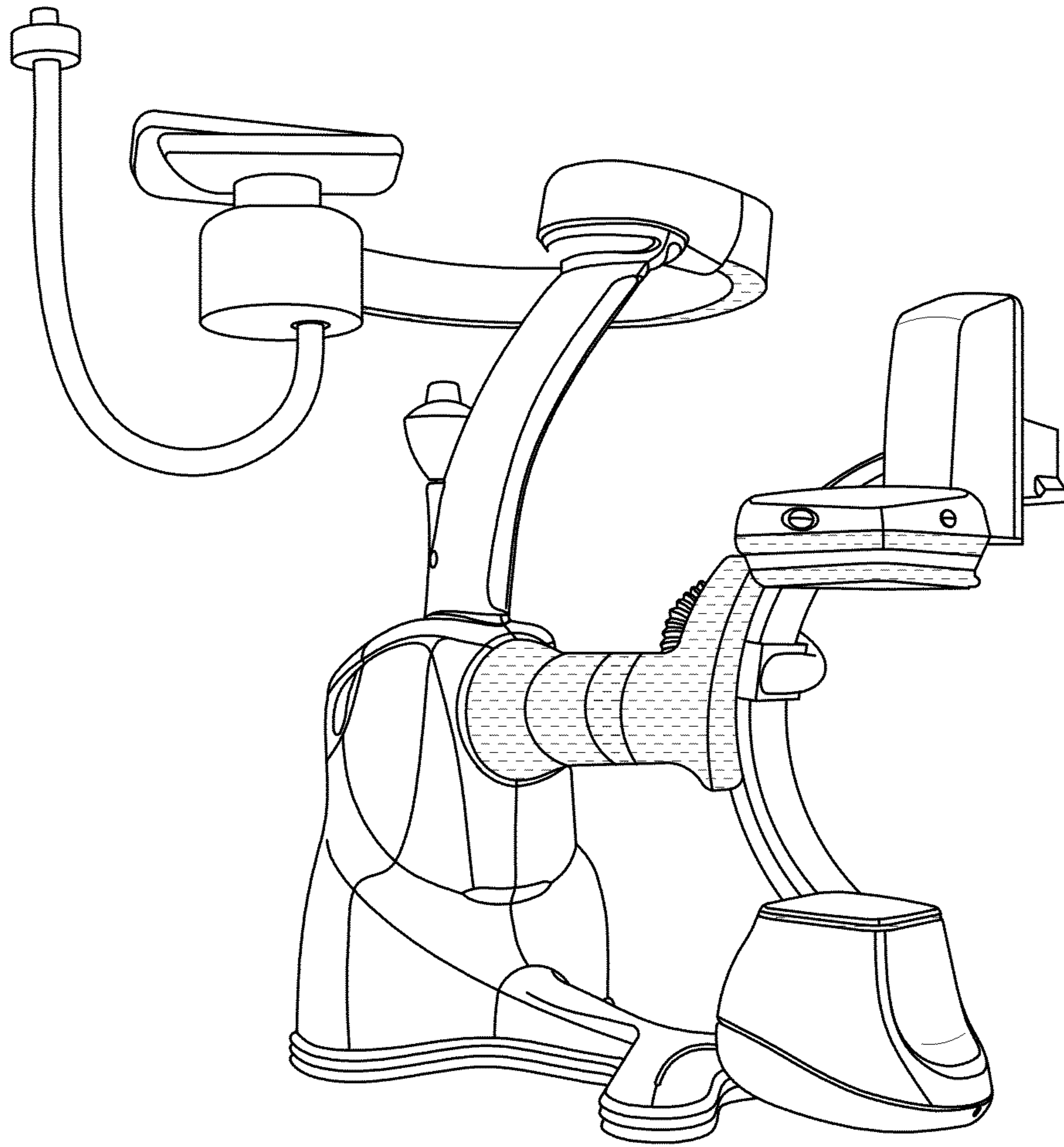

FIG. 1

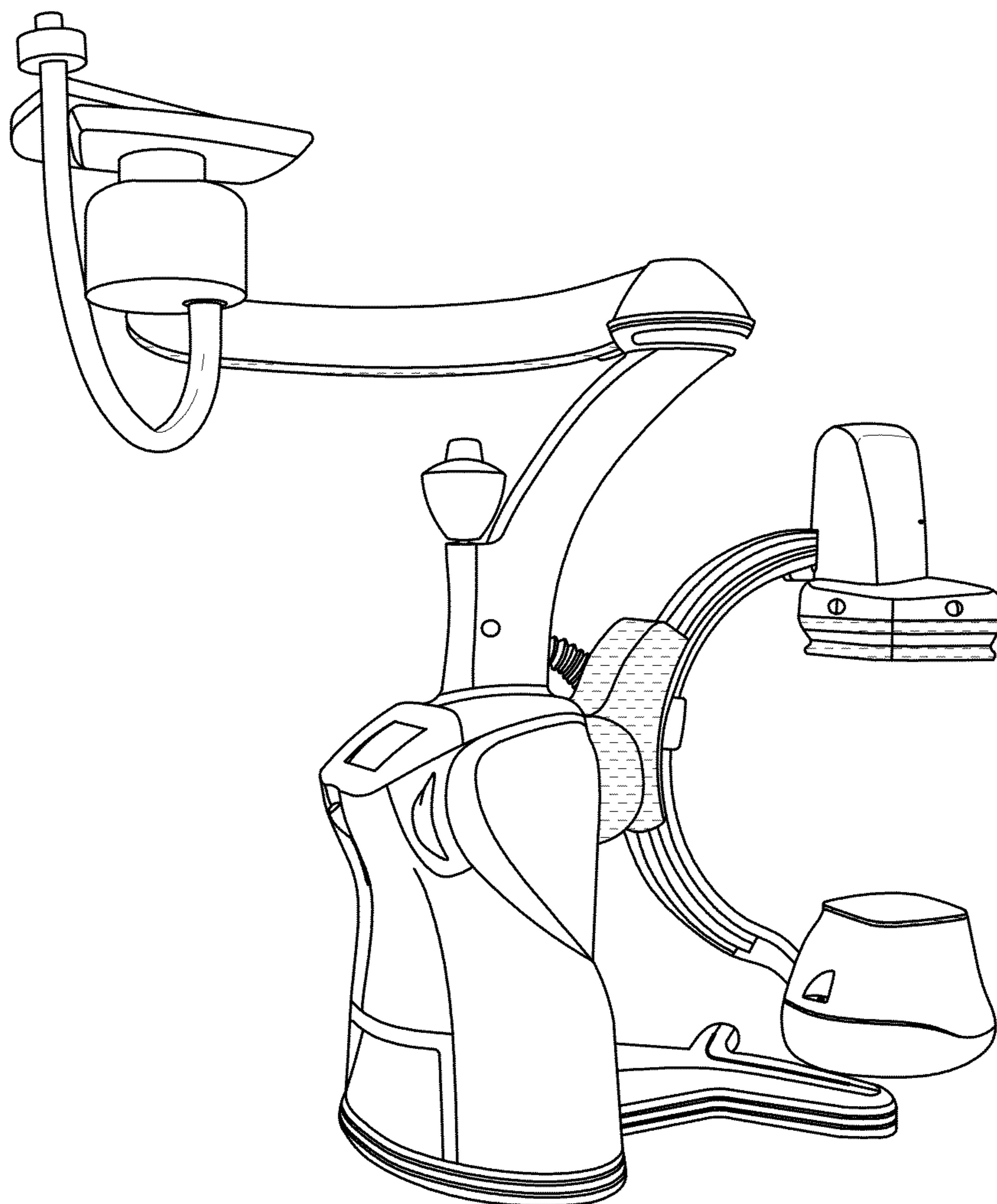

FIG. 2

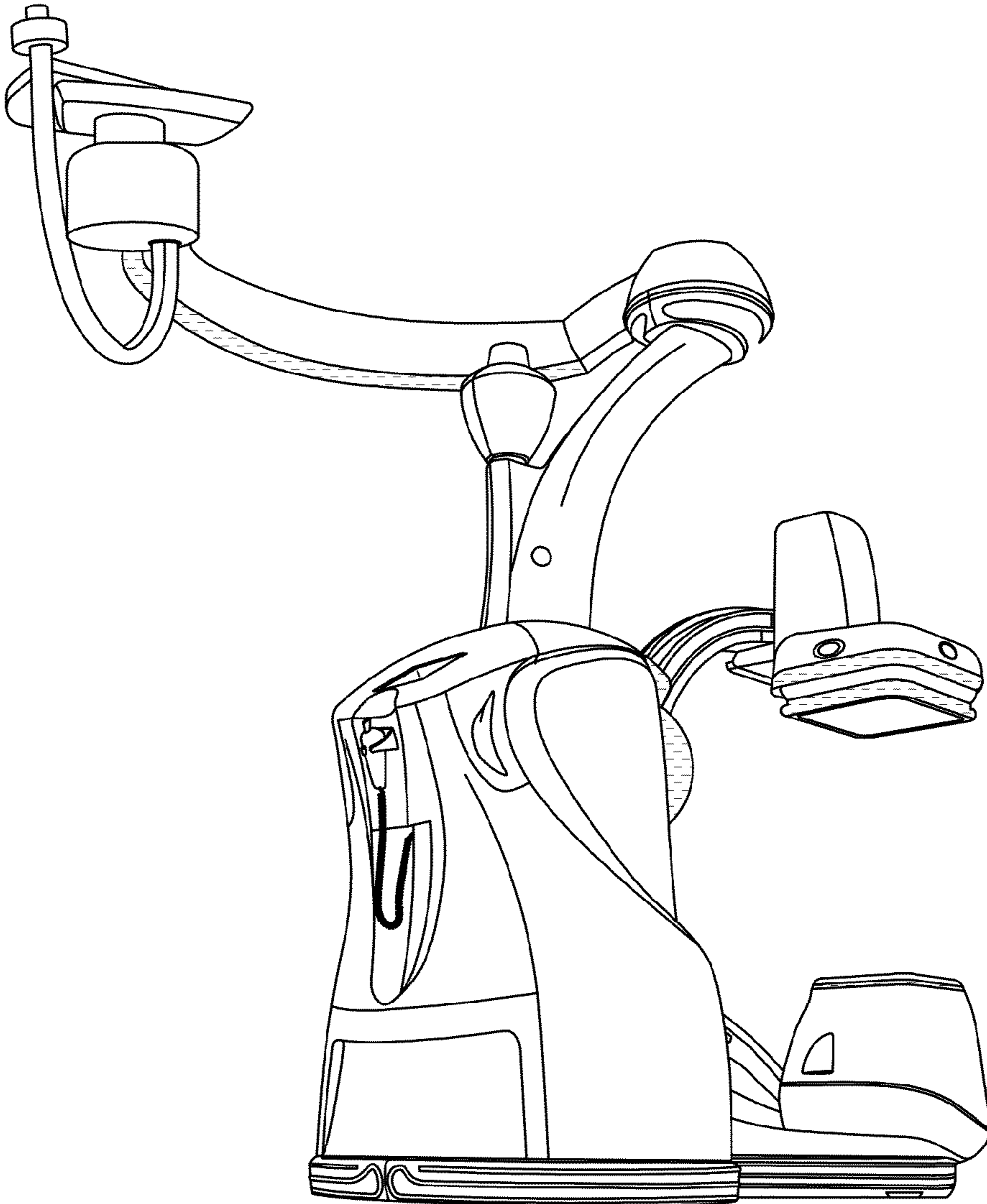

FIG. 3

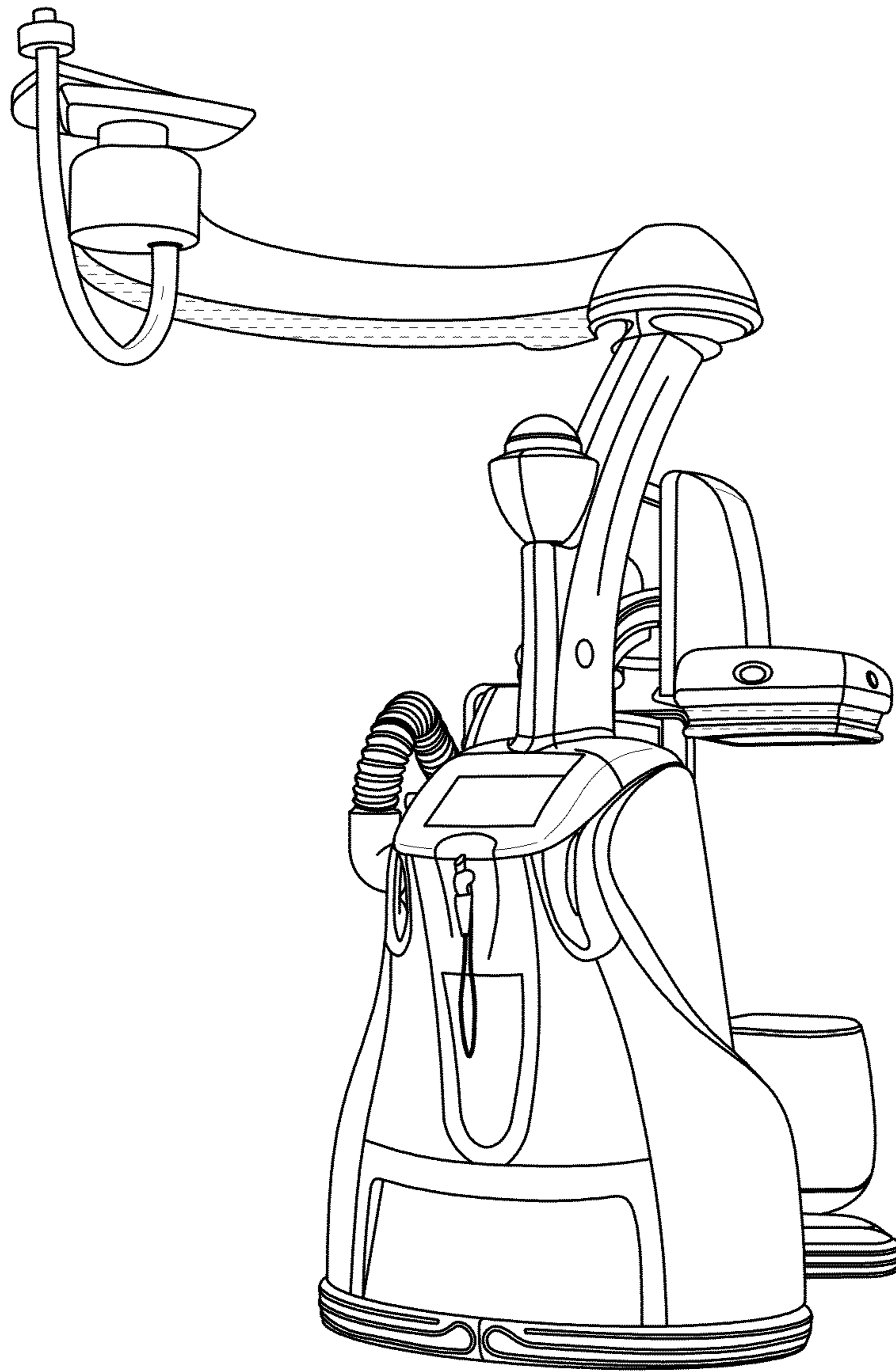

FIG. 4

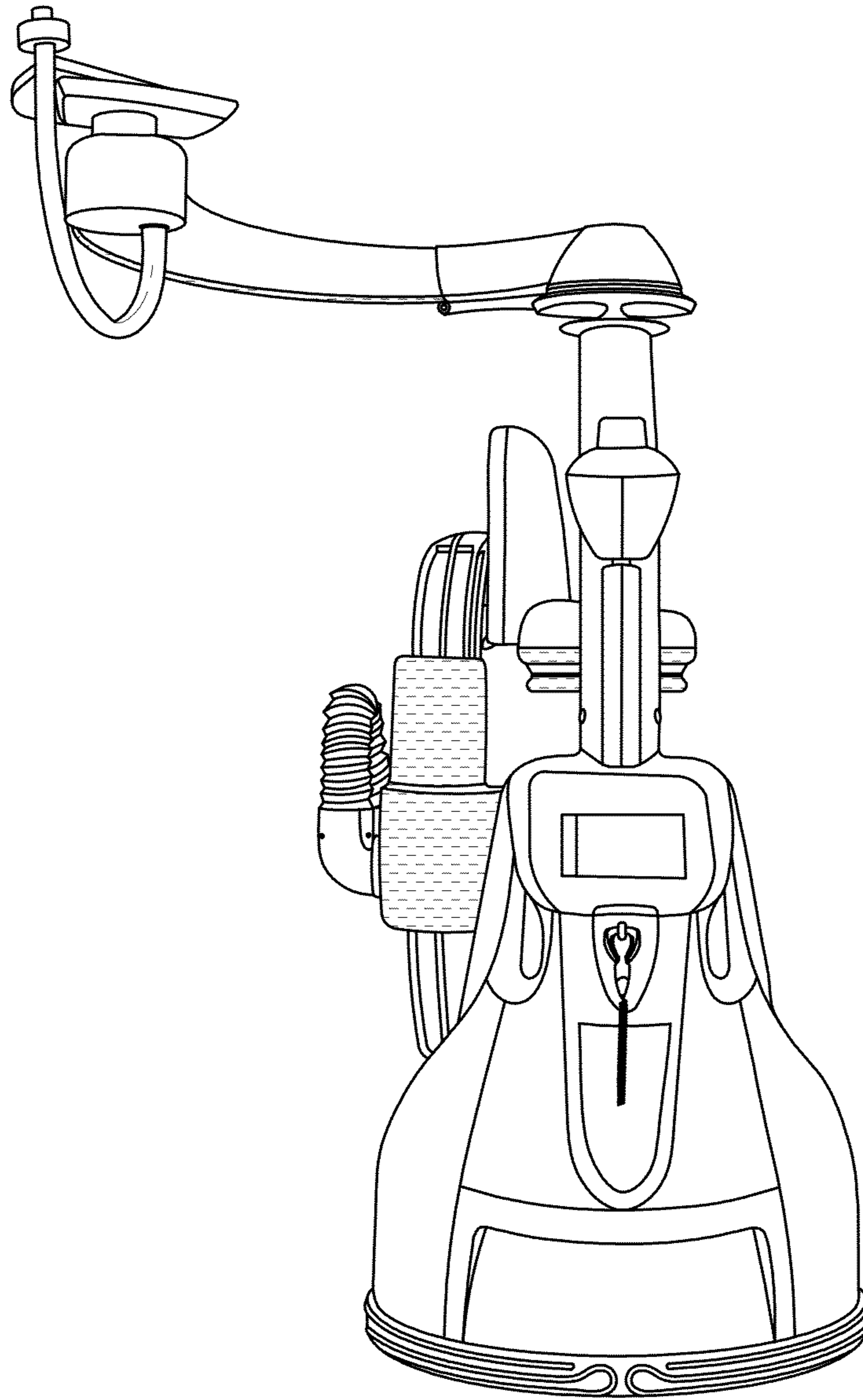

FIG. 5

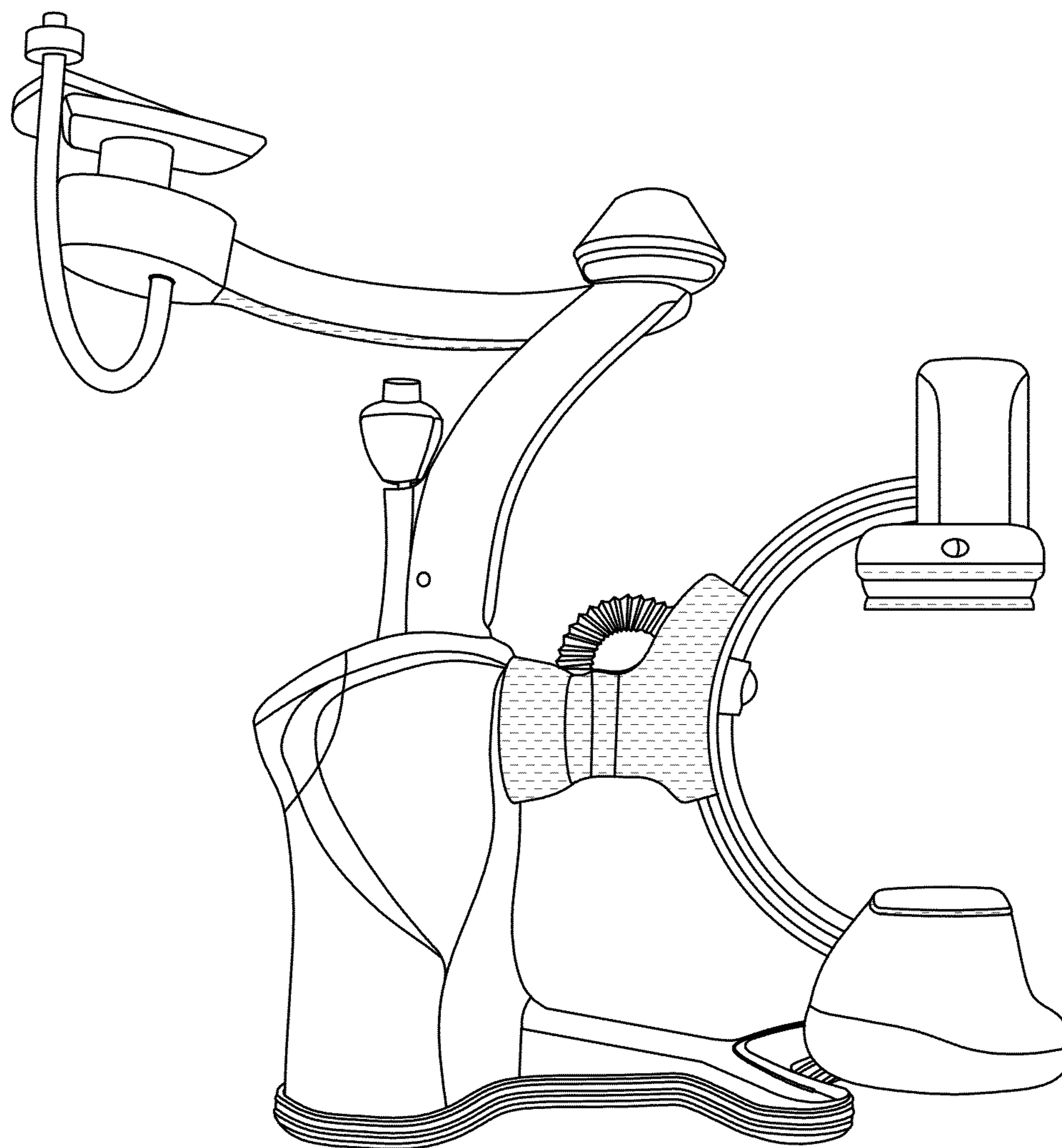

FIG. 6

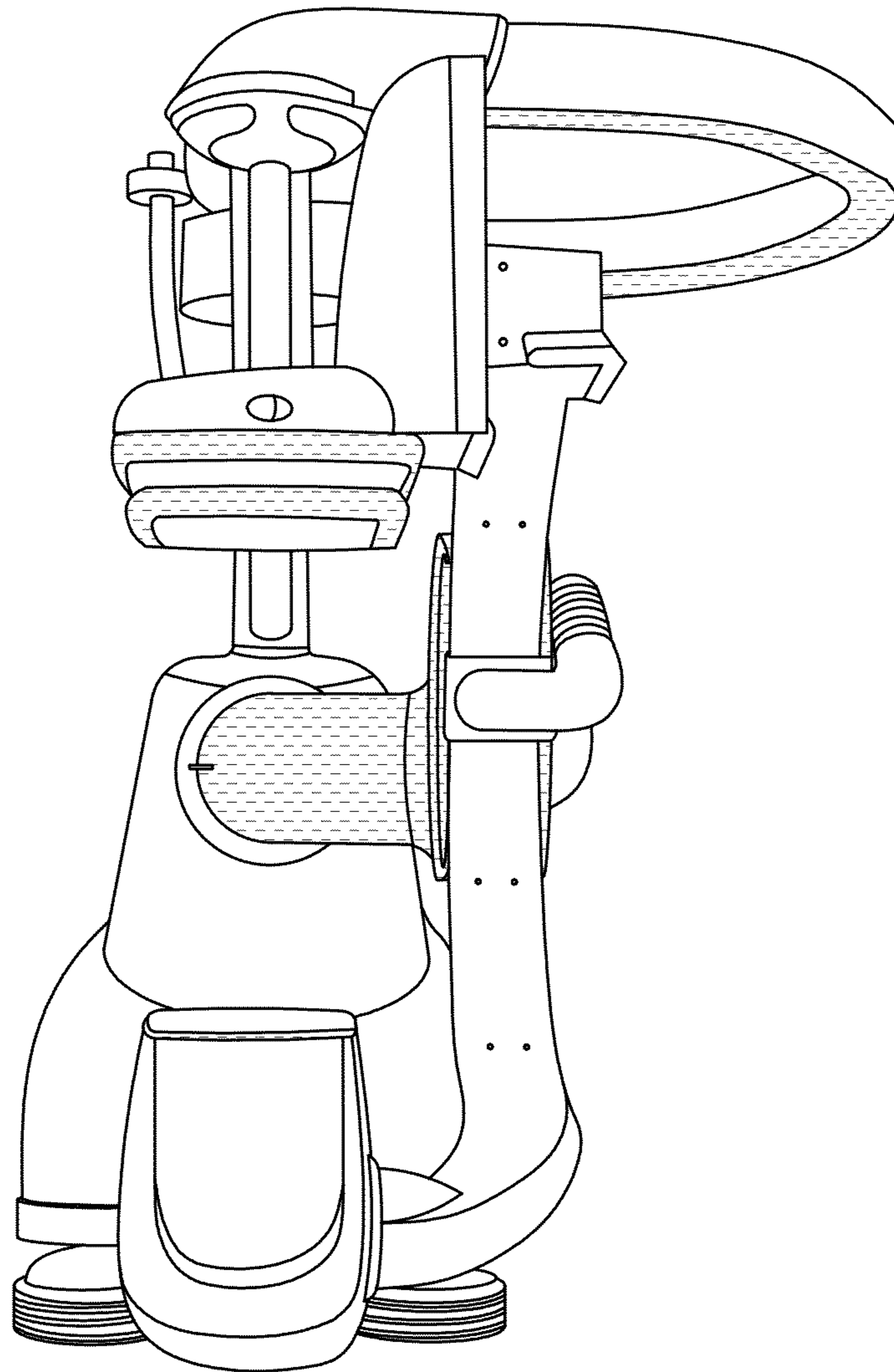

FIG. 7

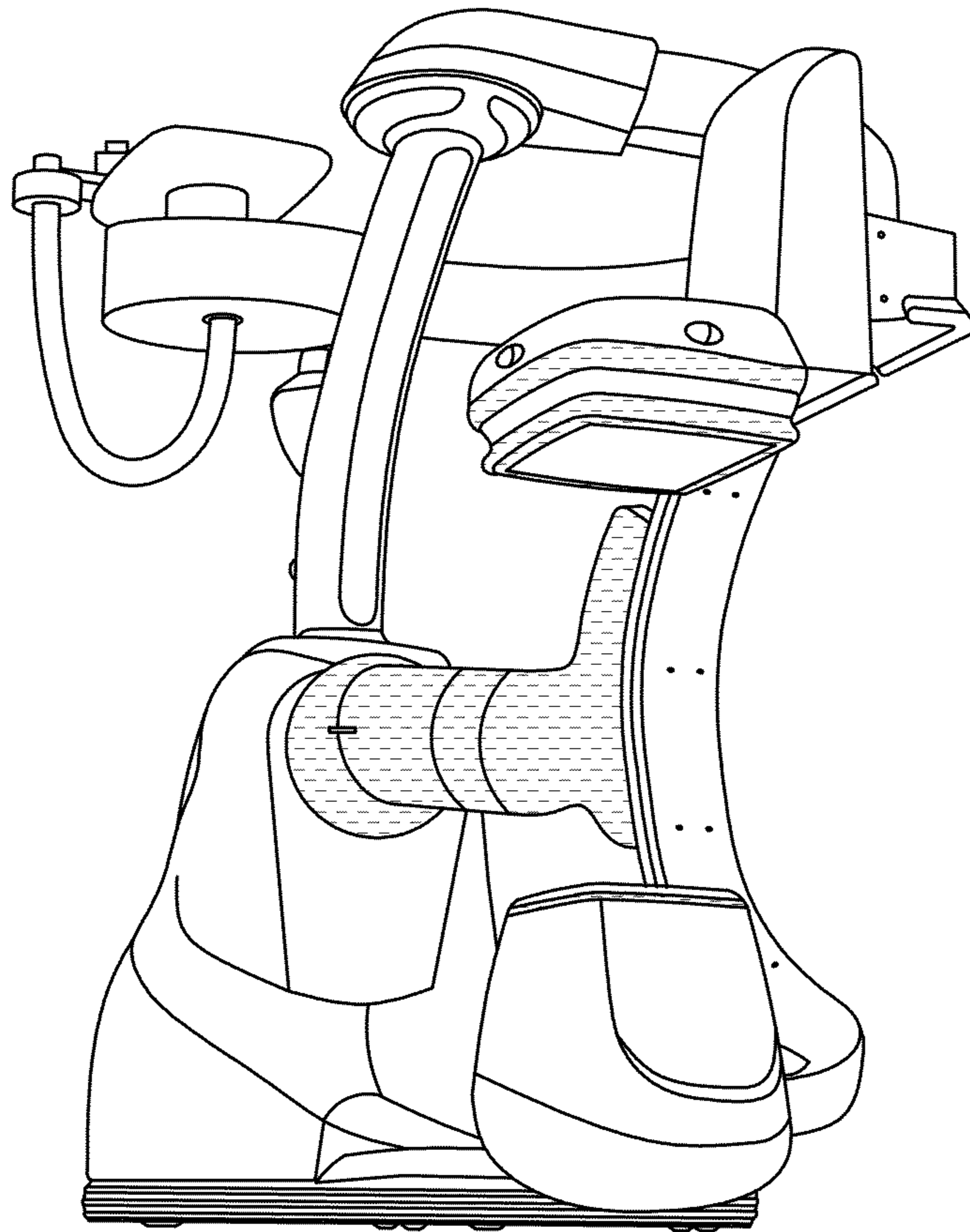

FIG. 8

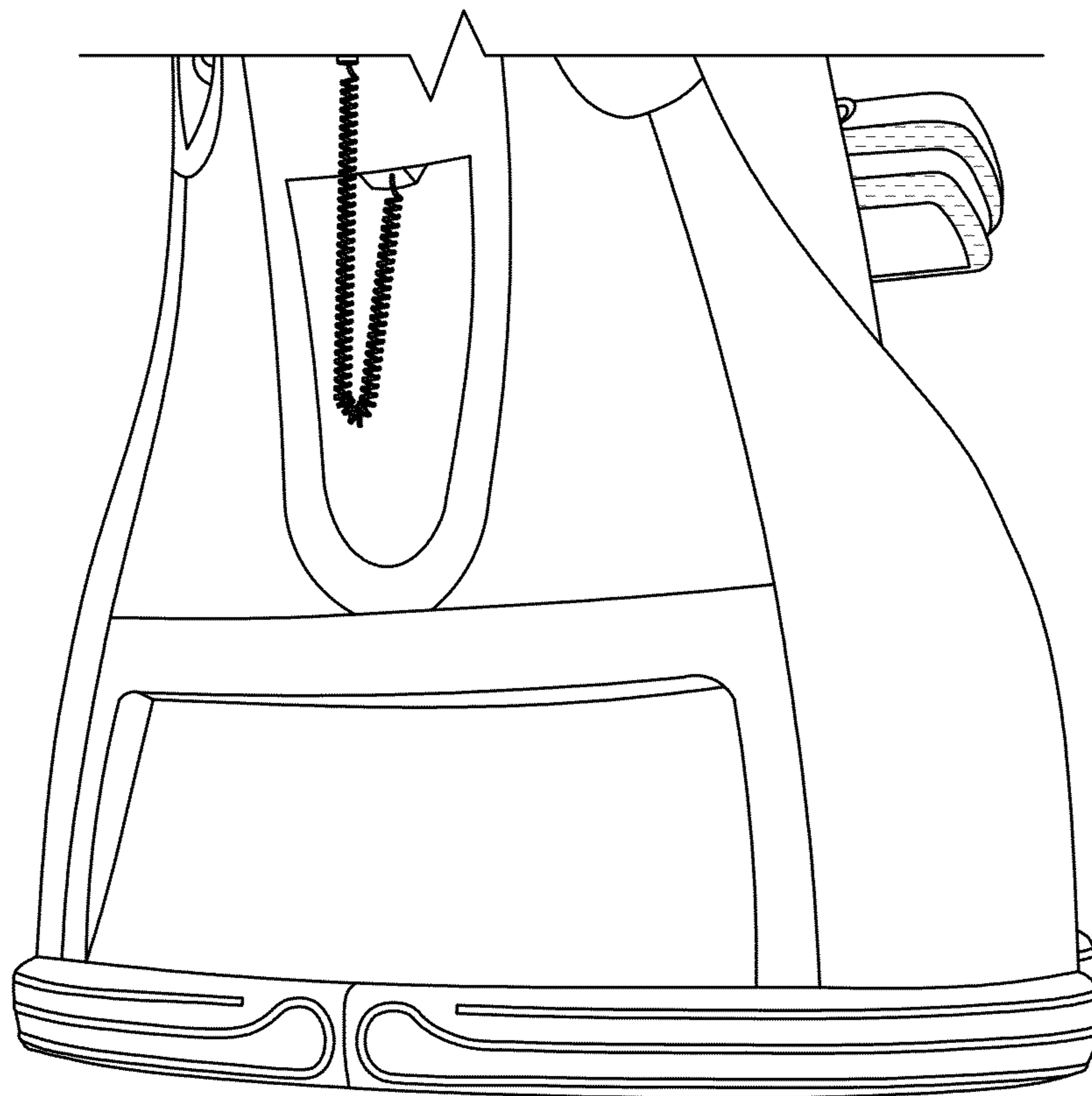

FIG. 9

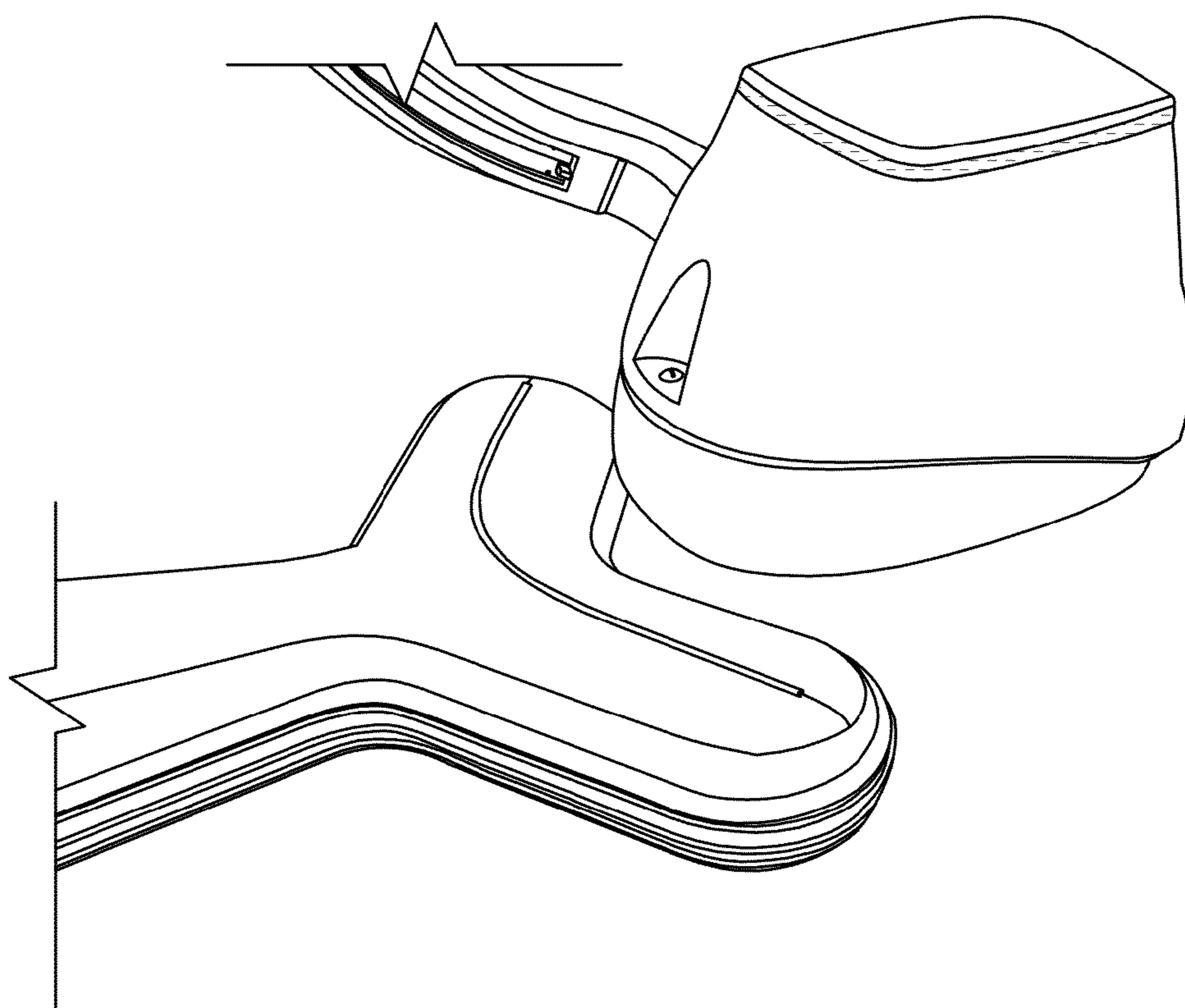

FIG. 10

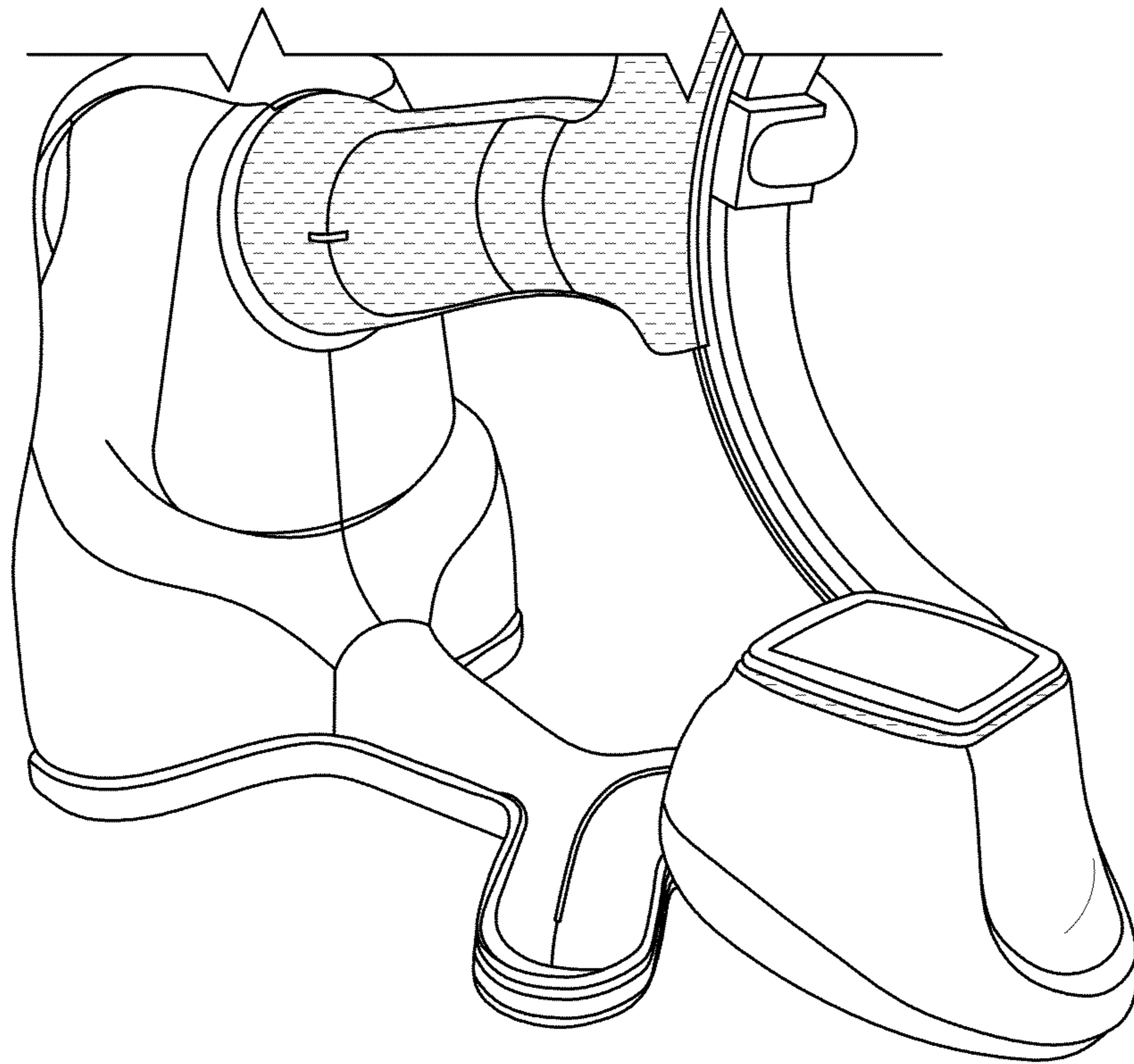

FIG. 11

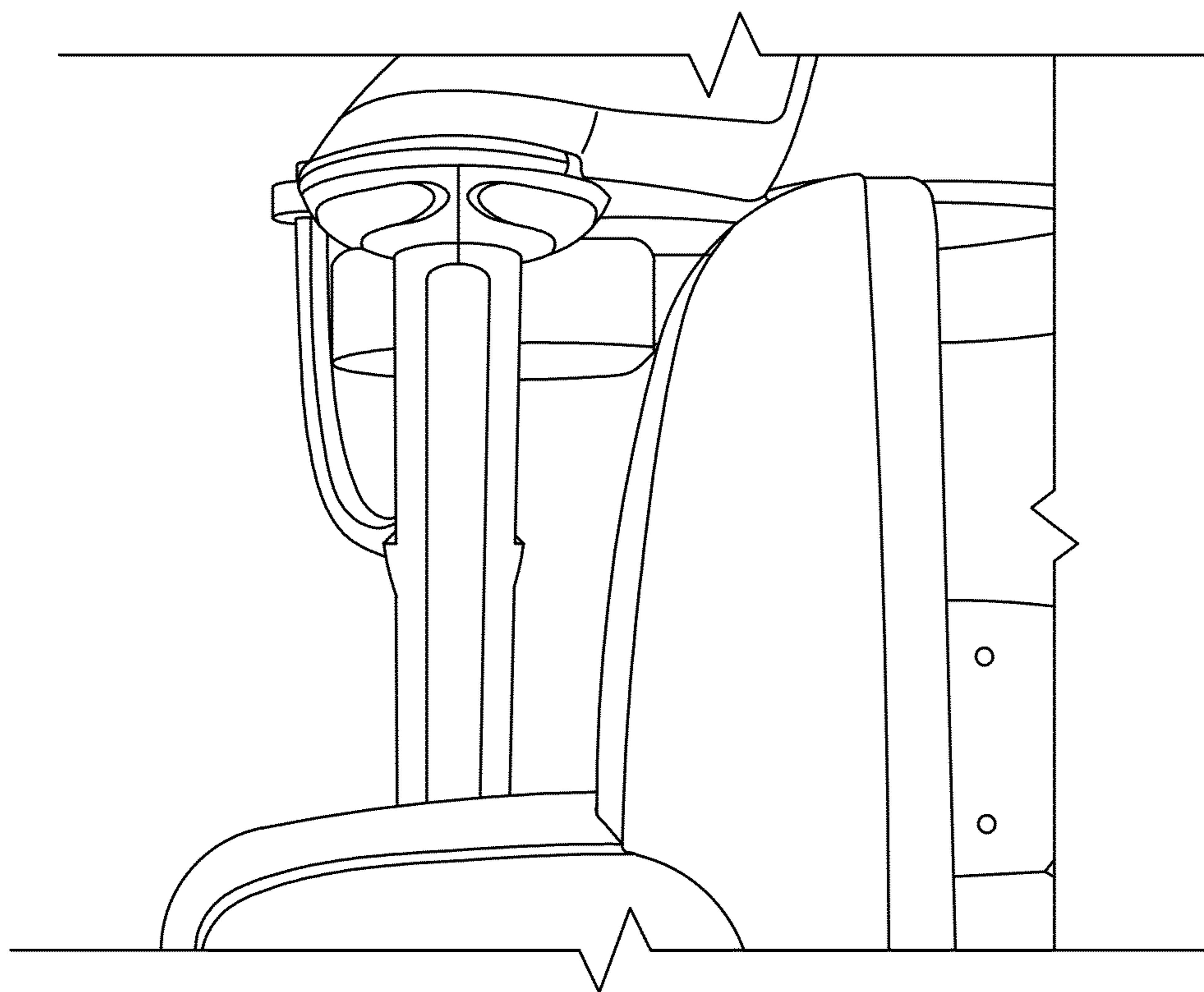

FIG. 12

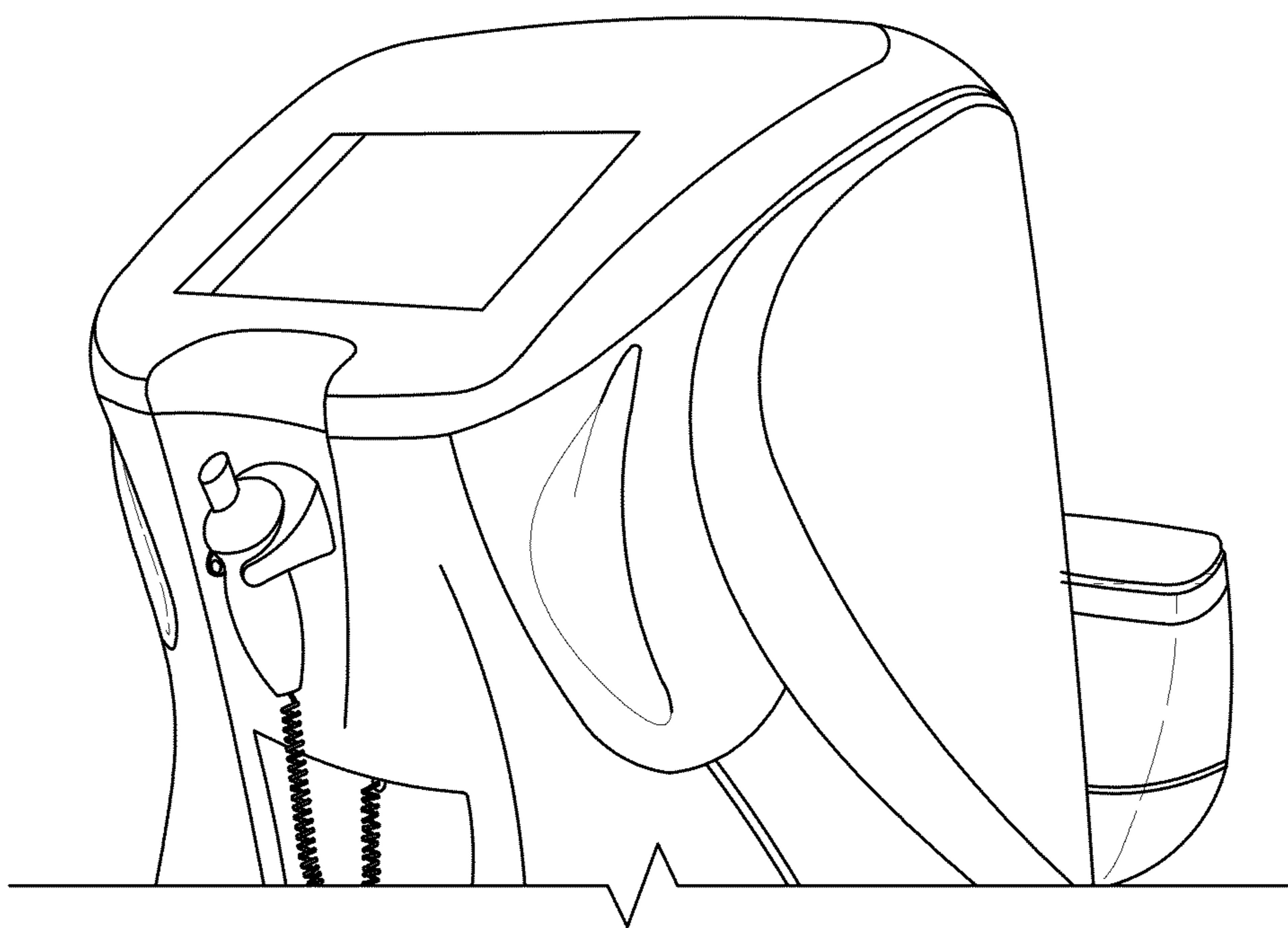

FIG. 13

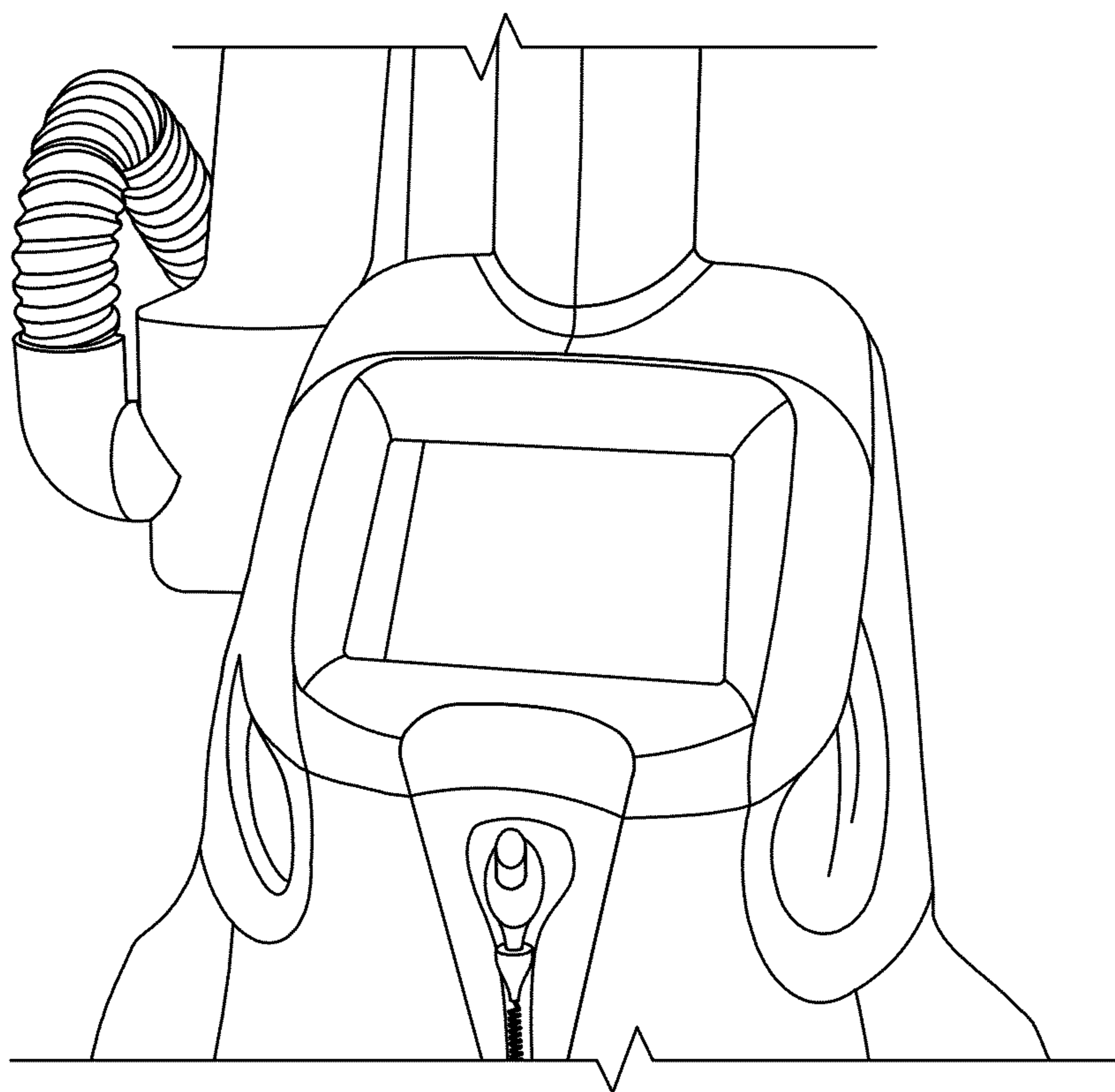

FIG. 14