



US00D725269S

(12) **United States Design Patent**
Chung et al.

(10) **Patent No.:** **US D725,269 S**
(45) **Date of Patent:** **** Mar. 24, 2015**

(54) **IMPLANT ASSEMBLY**

(71) Applicant: **Genoss Co., Ltd.**, Suwon-si,
Gyeonggi-do (KR)

(72) Inventors: **Sung-Min Chung**, Suwon-si (KR);
Sung-Geun Lee, Suwon-si (KR);
Sang-Yoon Kim, Suwon-si (KR)

(73) Assignee: **Genoss Co., Ltd.**, Suwon-si,
Gyeonggi-do (KR)

(**) Term: **14 Years**

(21) Appl. No.: **29/443,713**

(22) Filed: **Jan. 22, 2013**

(30) **Foreign Application Priority Data**

Dec. 17, 2012 (KR) 30-2012-0060799

(51) **LOC (10) Cl.** **24-02**

(52) **U.S. Cl.**
USPC **D24/155**

(58) **Field of Classification Search**
USPC D24/155, 156, 176; 606/194, 198, 106,
606/304, 374; D8/387, 310-312; 411/178,
411/378; D15/21, 28; 433/172-174,
433/191-195; 623/17.16, 17.17, 11.11,
623/23.26, 23.27

See application file for complete search history.

(56) **References Cited**

U.S. PATENT DOCUMENTS

D565,181 S * 3/2008 Anitua Aldecoa D24/156
D577,122 S * 9/2008 Aldecoa D24/156

D583,945 S * 12/2008 Anitua Aldecoa D24/156
D588,699 S * 3/2009 Aldecoa D24/156
D588,700 S * 3/2009 Anitua Aldecoa D24/156
D603,512 S * 11/2009 Emanuelli D24/156
D603,513 S * 11/2009 Emanuelli D24/156
D603,514 S * 11/2009 Emanuelli D24/156
D604,851 S * 11/2009 Ishikawa D24/156
D605,291 S * 12/2009 Ishikawa D24/156
7,905,905 B2 * 3/2011 Cragg et al. 606/246
D665,910 S * 8/2012 Hung D24/156
D666,295 S * 8/2012 Hung D24/156
D668,764 S * 10/2012 Lussi et al. D24/156
D689,610 S * 9/2013 Dukhan D24/156

* cited by examiner

Primary Examiner — Ian Simmons

Assistant Examiner — Charles Hanson

(74) *Attorney, Agent, or Firm* — Davis & Bujold, PLLC;
Michael J. Bujold

(57) **CLAIM**

The ornamental design for an implant assembly, as shown and described.

DESCRIPTION

FIG. 1 is a perspective view of an implant assembly;
FIG. 2 is a front view thereof;
FIG. 3 is a back view thereof;
FIG. 4 is a left side view thereof;
FIG. 5 is a right side view thereof;
FIG. 6 is a top view thereof; and,
FIG. 7 is a bottom view of an implant assembly.
The broken line showing is included for the purpose of illustrating environment and forms no part of the claimed design.

1 Claim, 7 Drawing Sheets

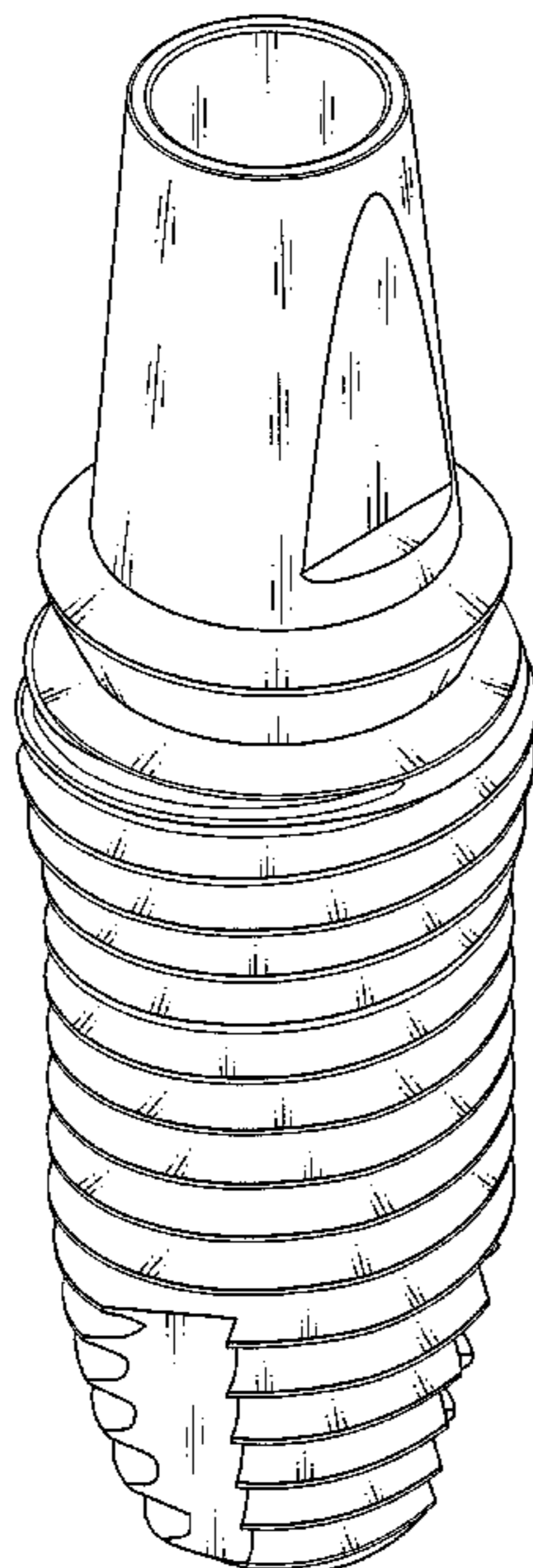

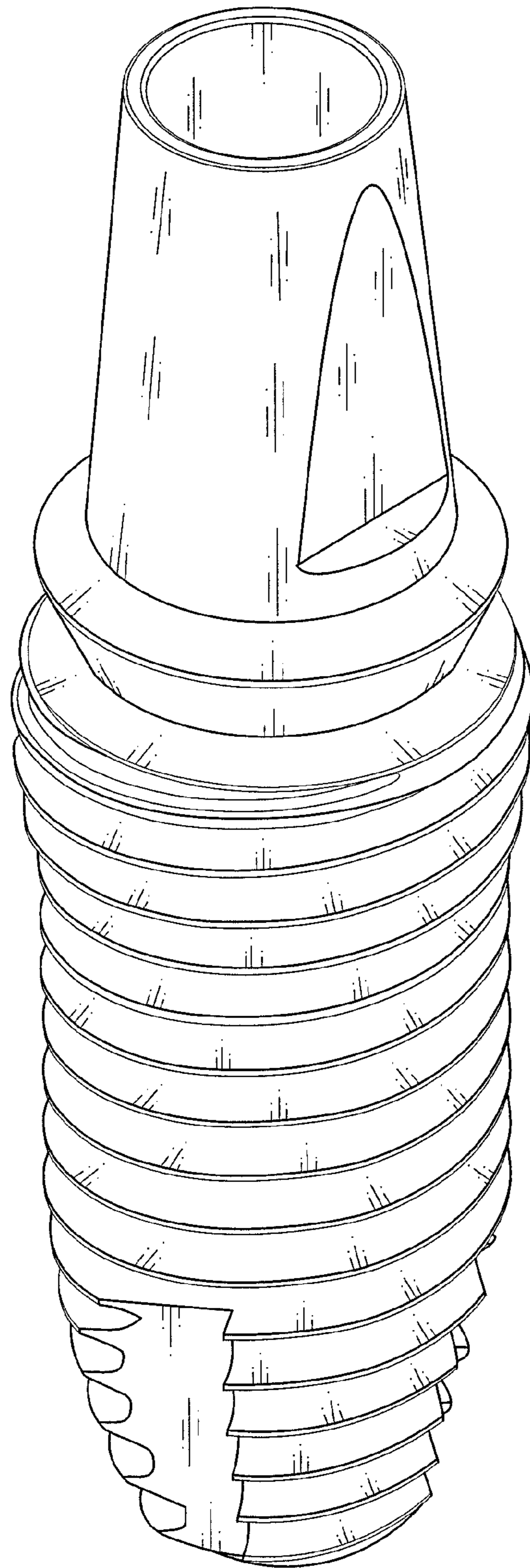

FIG. 1

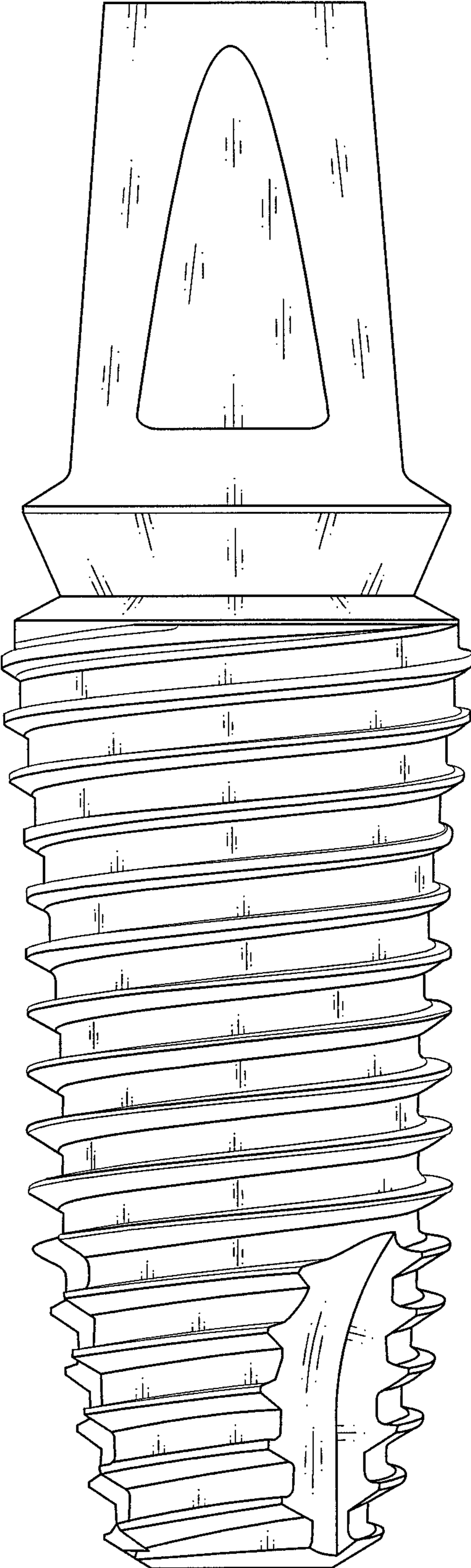

FIG.2

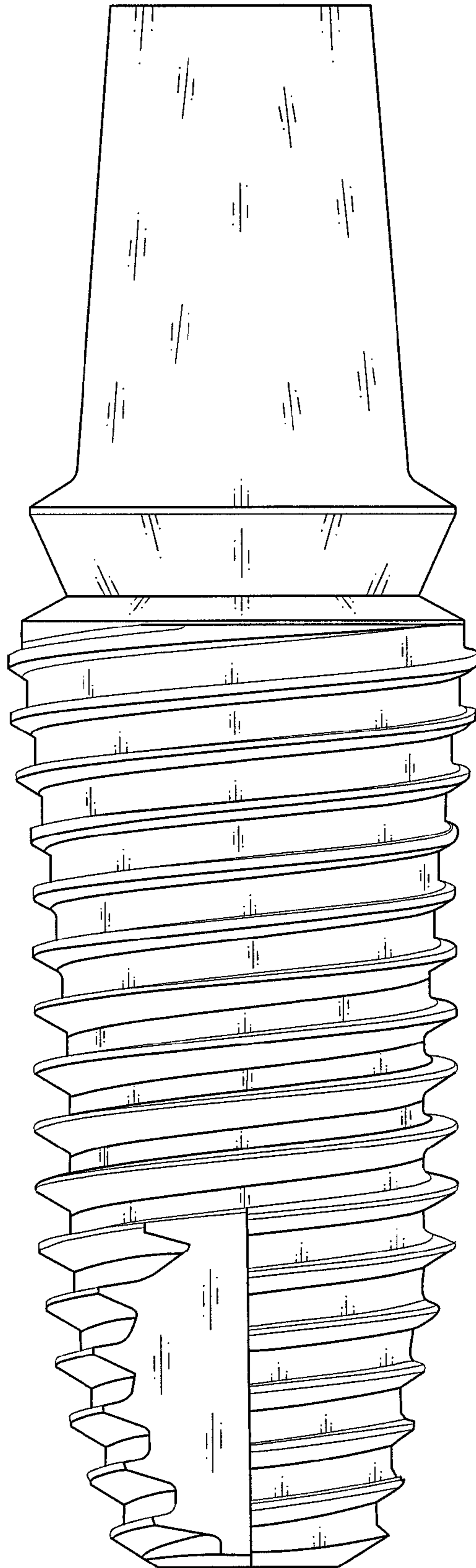

FIG.3

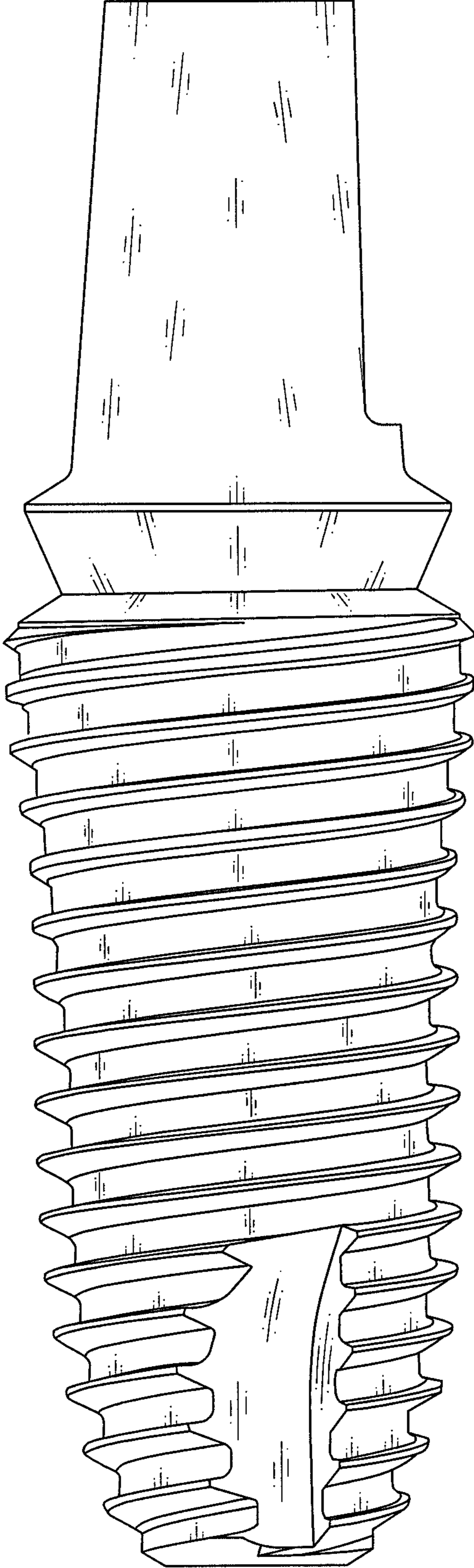

FIG.4

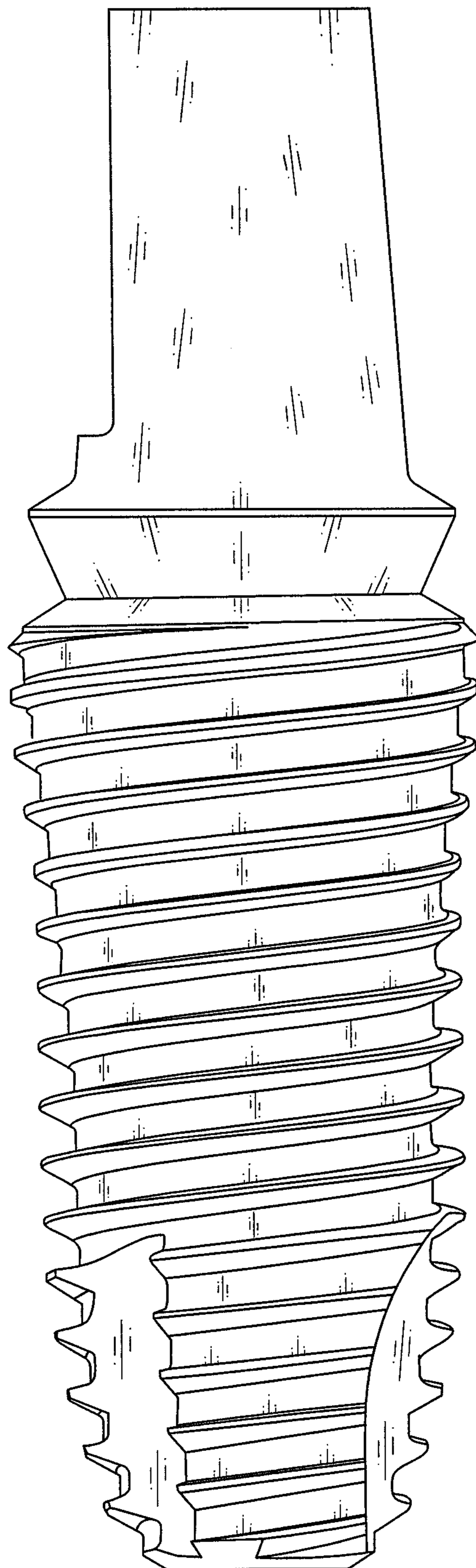

FIG.5

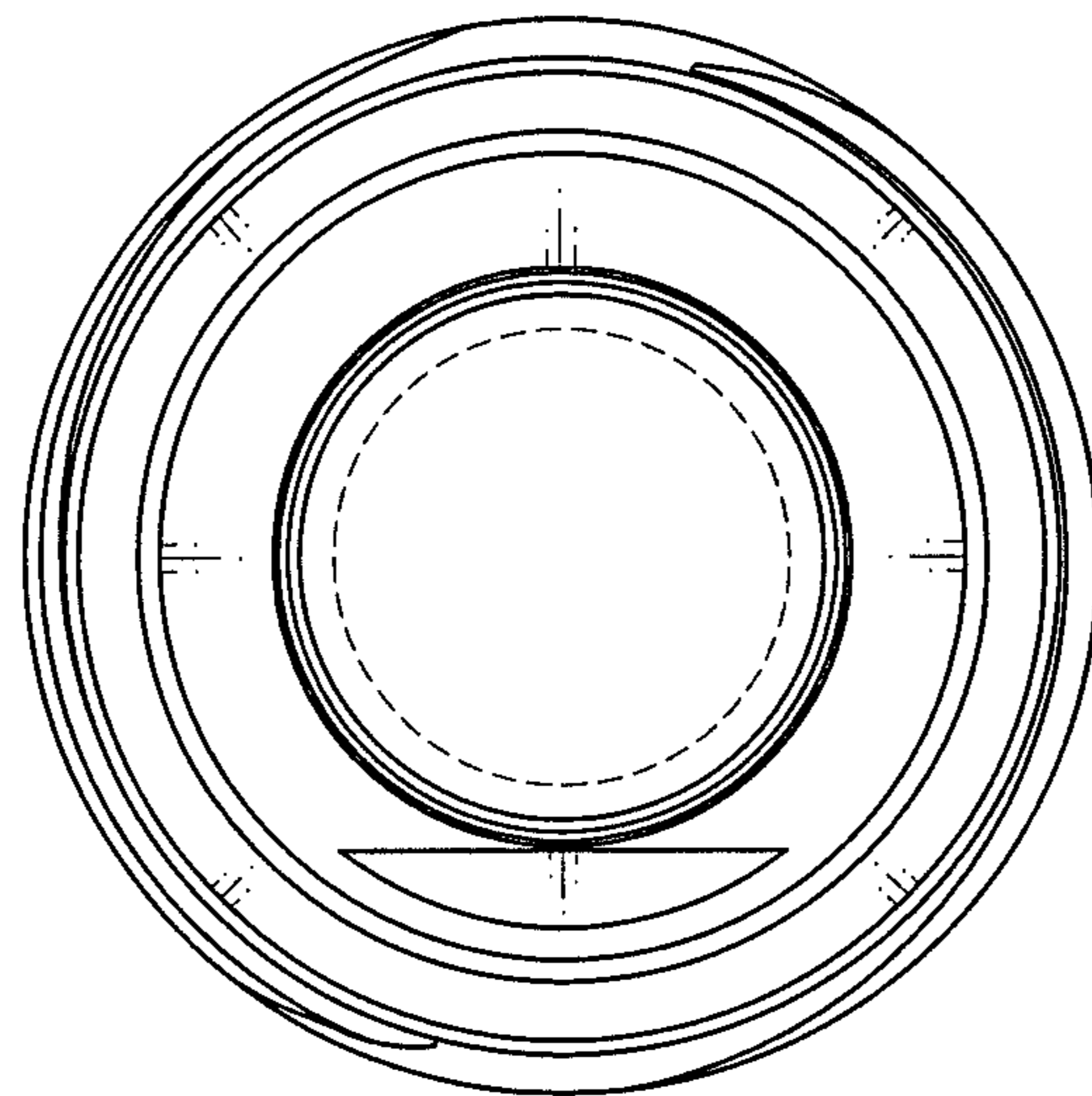

FIG.6

FIG. 7

