



US00D725111S

(12) **United States Design Patent**
Jeong et al.

(10) **Patent No.:** **US D725,111 S**
(45) **Date of Patent:** **** Mar. 24, 2015**

(54) **ELECTRONIC MOUSE**
(71) Applicant: **Microsoft Corporation**, Redmond, WA
(US)
(72) Inventors: **Sang Hyun Jeong**, Gong Ju (KR);
Michael Zheng, Shenzhen (CN)
(73) Assignee: **Microsoft Corporation**, Redmond, WA
(US)

| | | | |
|--------------|--------|----------------------|---------|
| D651,604 S * | 1/2012 | Fischer | D14/408 |
| D656,498 S * | 3/2012 | Kujawski et al. | D14/402 |
| D657,359 S * | 4/2012 | Kujawski et al. | D14/402 |
| D657,360 S * | 4/2012 | Kujawski et al. | D14/402 |
| D658,650 S * | 5/2012 | Kujawski et al. | D14/402 |
| D667,009 S * | 9/2012 | Kujawski et al. | D14/408 |
| D676,849 S * | 2/2013 | Kujawski et al. | D14/408 |
| D688,243 S * | 8/2013 | Widiaman et al. | D14/408 |
| D688,244 S * | 8/2013 | Widiaman | D14/408 |
| D689,494 S * | 9/2013 | Widiaman et al. | D14/408 |

* cited by examiner

(**) Term: **14 Years**

Primary Examiner — Austin Murphy

(21) Appl. No.: **29/502,546**

(74) *Attorney, Agent, or Firm* — Banner & Witcoff, Ltd.

(22) Filed: **Sep. 17, 2014**

(57) **CLAIM**

(51) **LOC (10) Cl.** **14-02**

The ornamental design for an electronic mouse, as shown and described.

(52) **U.S. Cl.**

USPC **D14/408**

(58) **Field of Classification Search**

DESCRIPTION

CPC G06F 3/03543; G06F 2203/0333;
G06F 3/039; G06F 3/038; G06F 2203/0384
USPC D14/402–411, 356, 388, 389, 383–385,
D14/417, 426; 345/156–167; 463/36–38;
358/471, 473; 273/148 B

See application file for complete search history.

FIG. 1 is a front perspective view of an electronic mouse showing our new design;
FIG. 2 is a top view thereof;
FIG. 3 is a right view thereof;
FIG. 4 is a left side view thereof;
FIG. 5 is a front side view thereof;
FIG. 6 is a rear view thereof; and,
FIG. 7 is a bottom view thereof.

The broken line showing of the remainder of the electronic mouse and the unshaded regions therein in FIGS. 1-7 is for environmental purposes only and forms no part of the claimed design.

(56) **References Cited**

U.S. PATENT DOCUMENTS

| | | | |
|--------------|--------|----------------------|---------|
| D591,747 S * | 5/2009 | Hu et al. | D14/402 |
| D591,748 S * | 5/2009 | Hu et al. | D14/402 |
| D630,214 S * | 1/2011 | Kim et al. | D14/408 |
| D630,217 S * | 1/2011 | Ng | D14/408 |
| D630,218 S * | 1/2011 | Kujawski et al. | D14/408 |

1 Claim, 5 Drawing Sheets

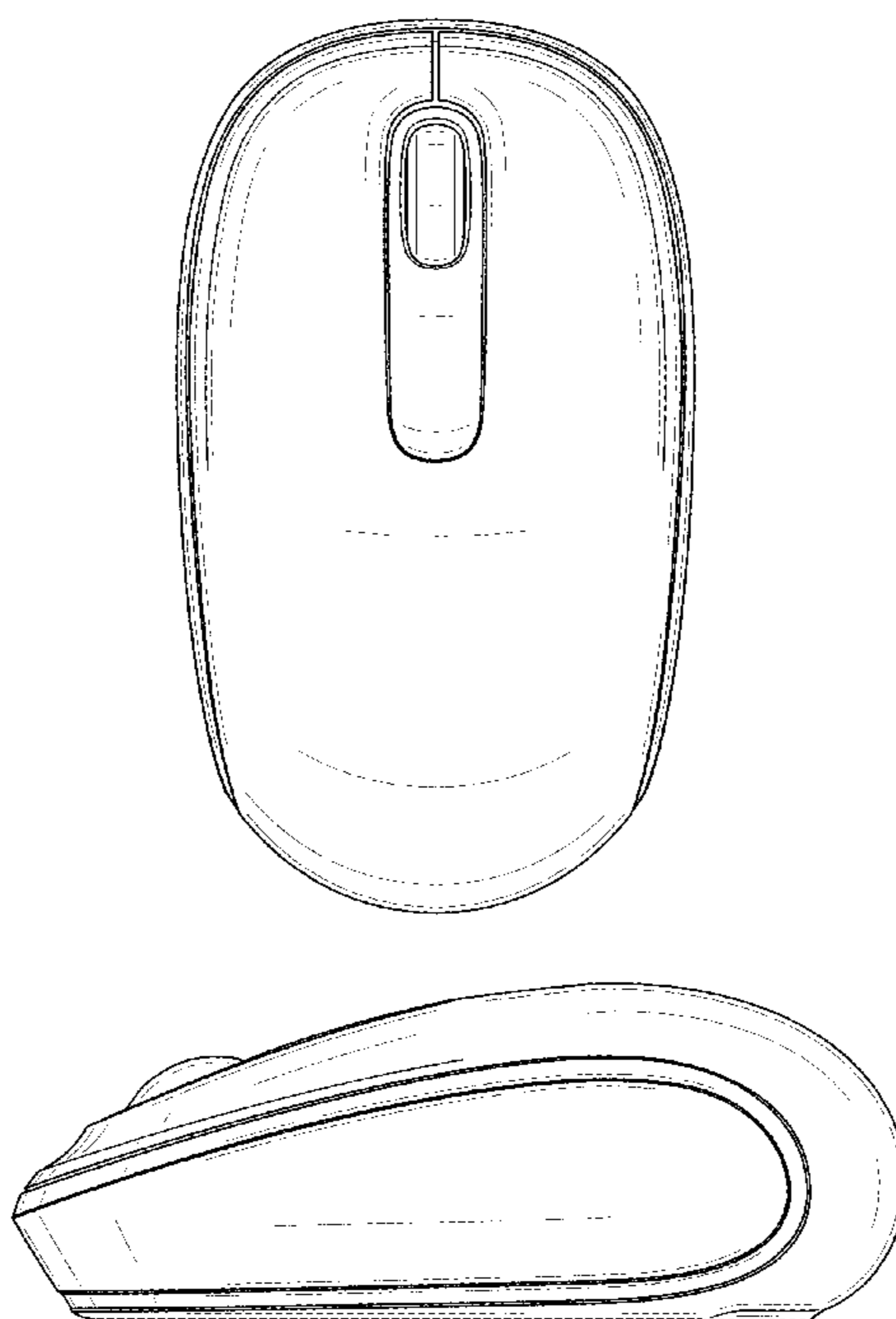

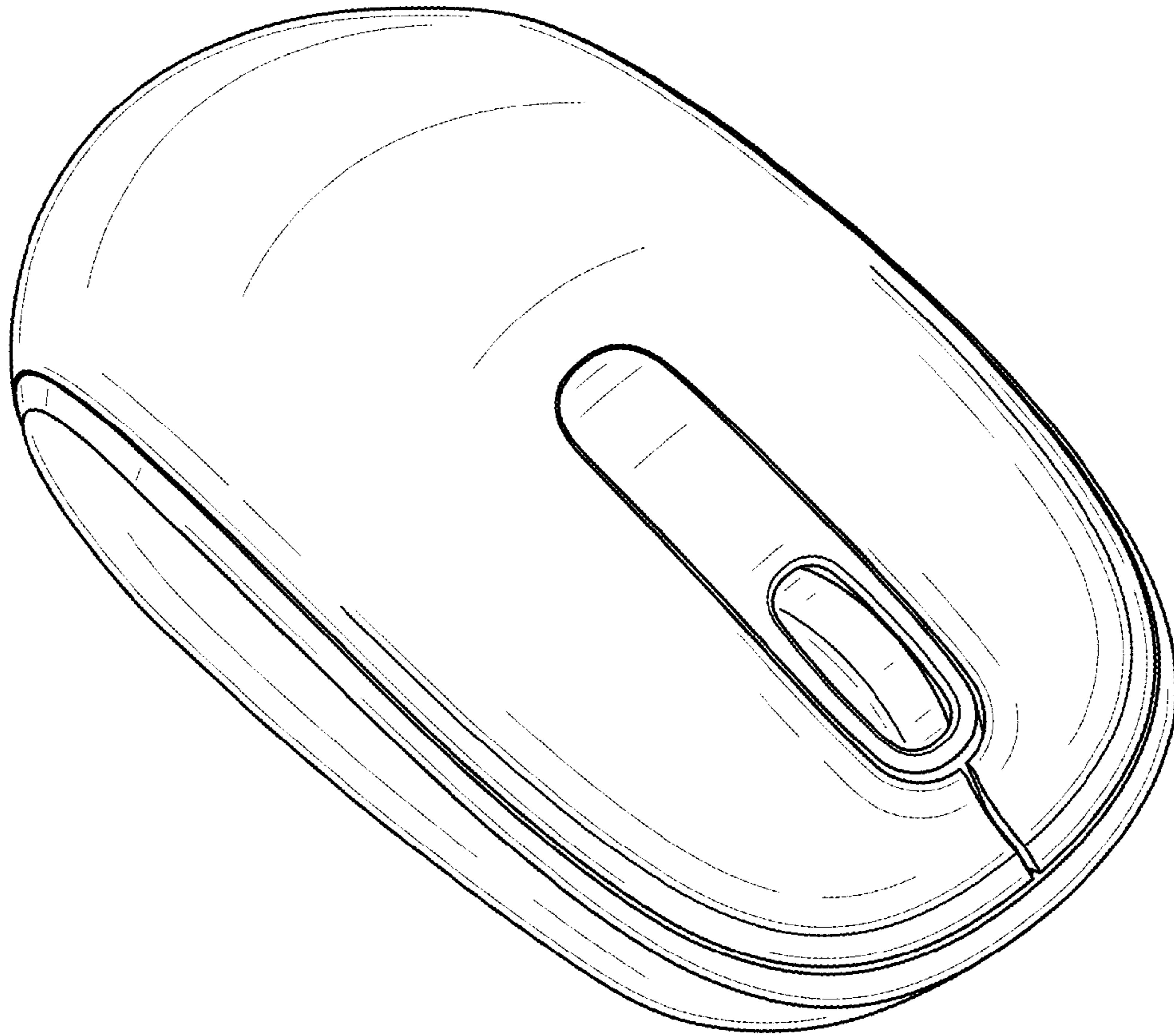

FIG. 1

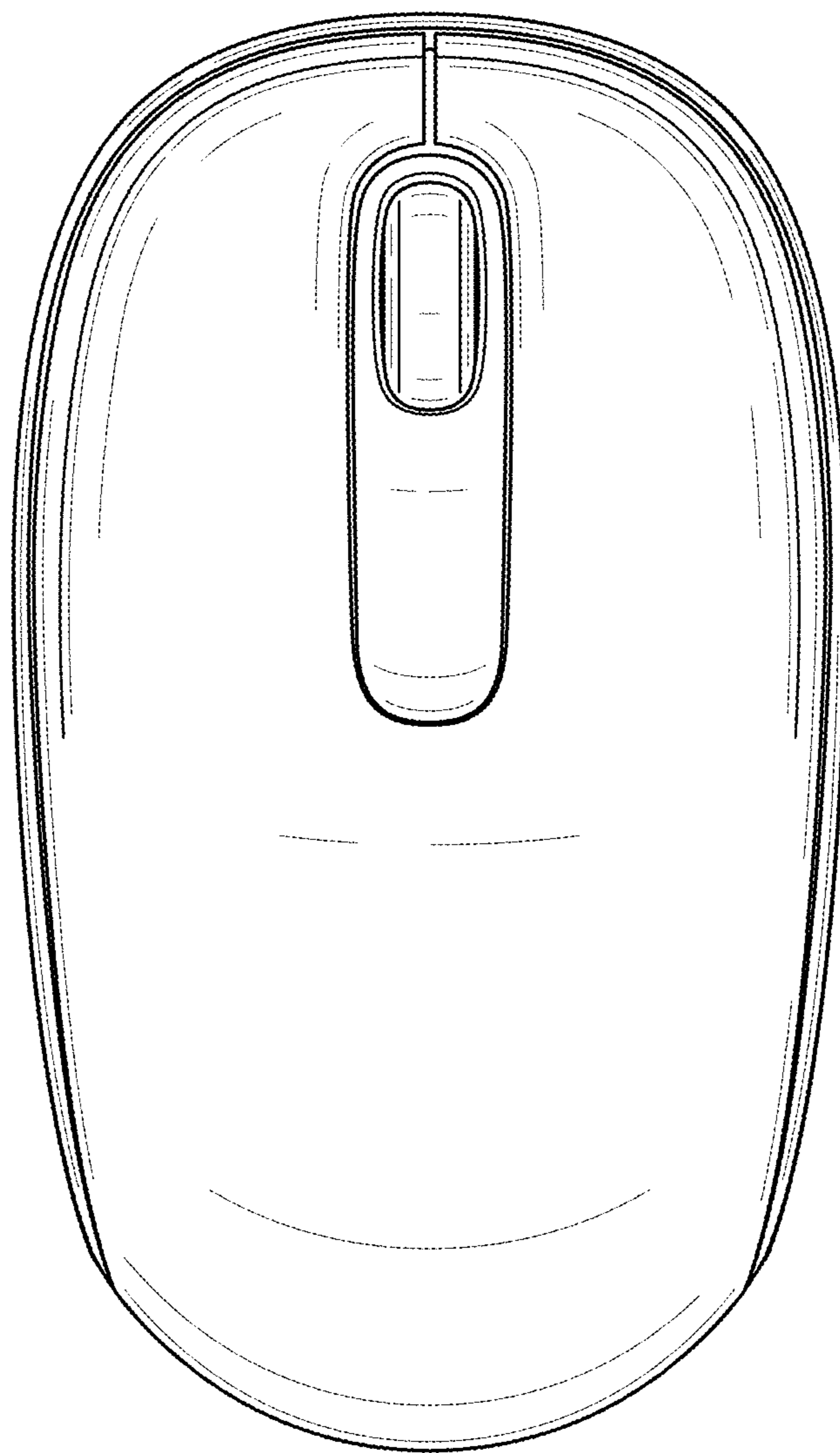

FIG. 2

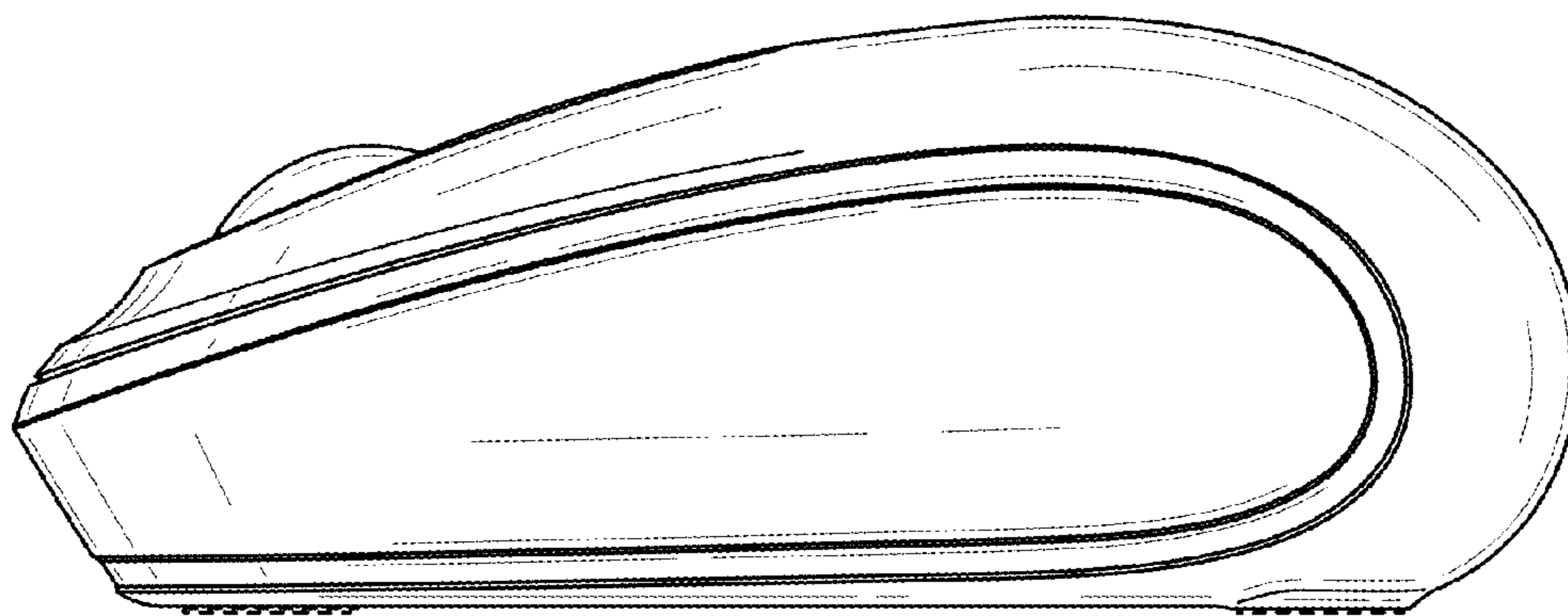

FIG. 3

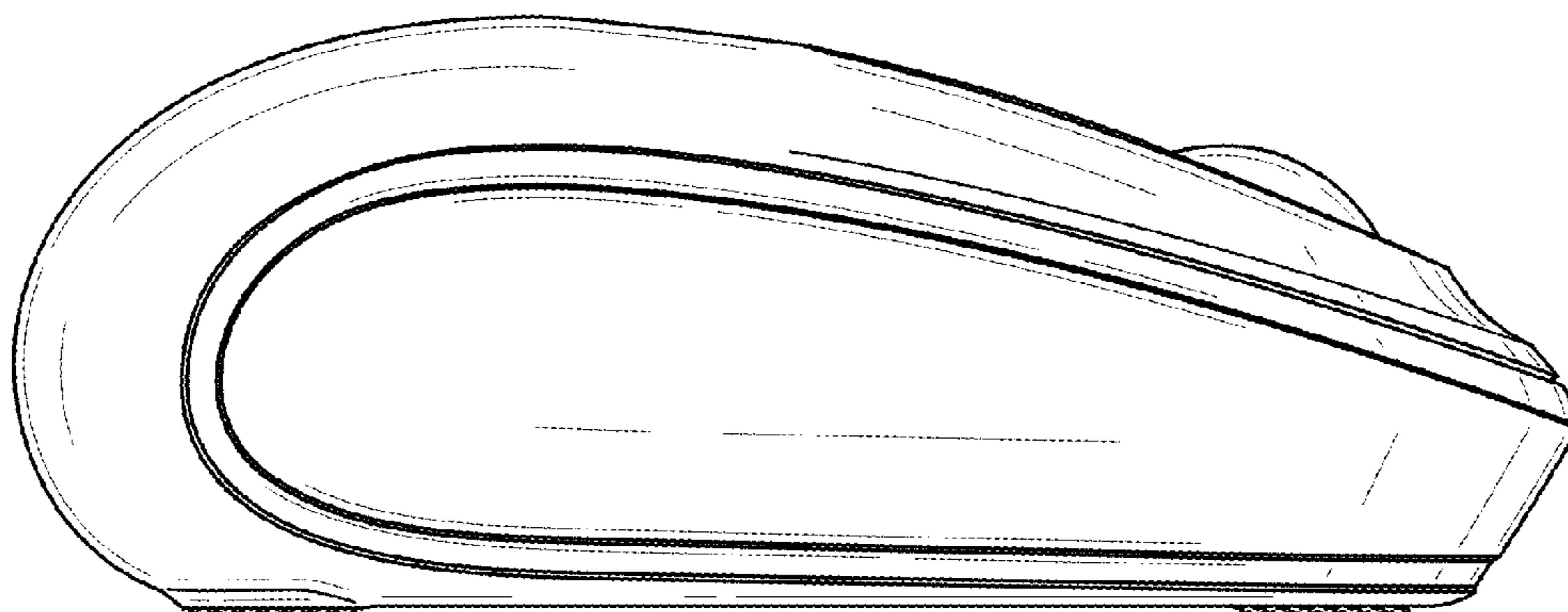

FIG. 4

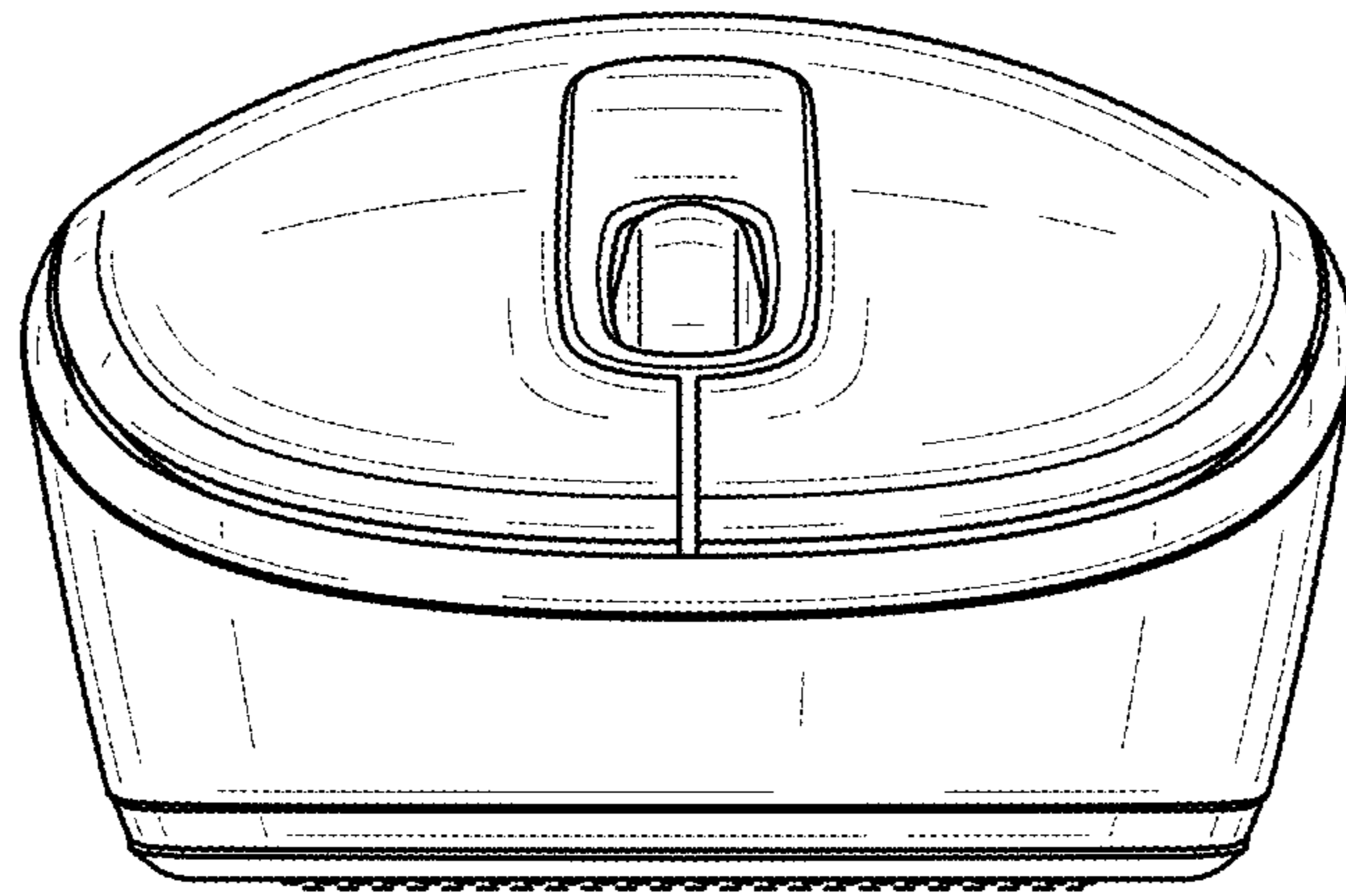

FIG. 5

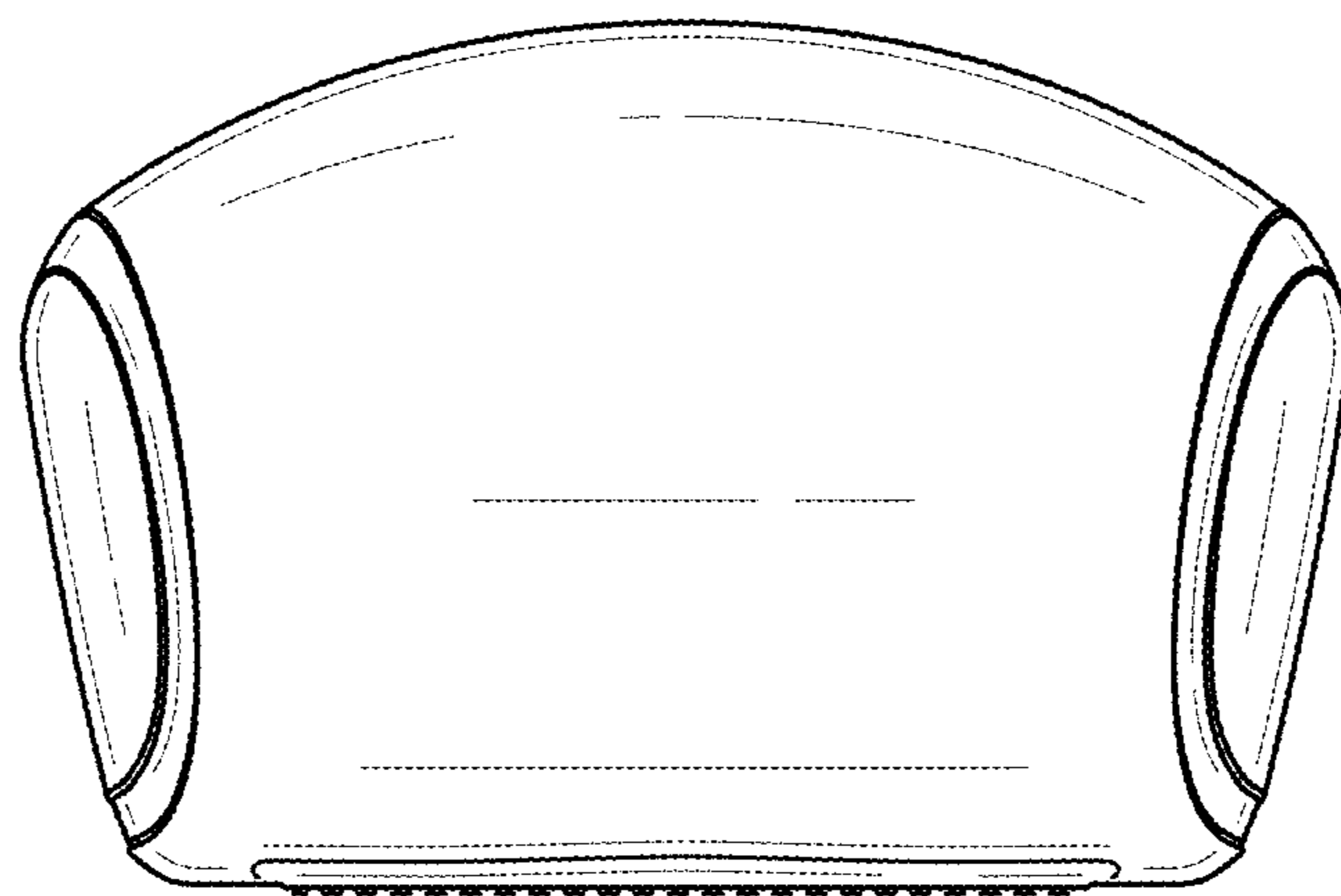

FIG. 6

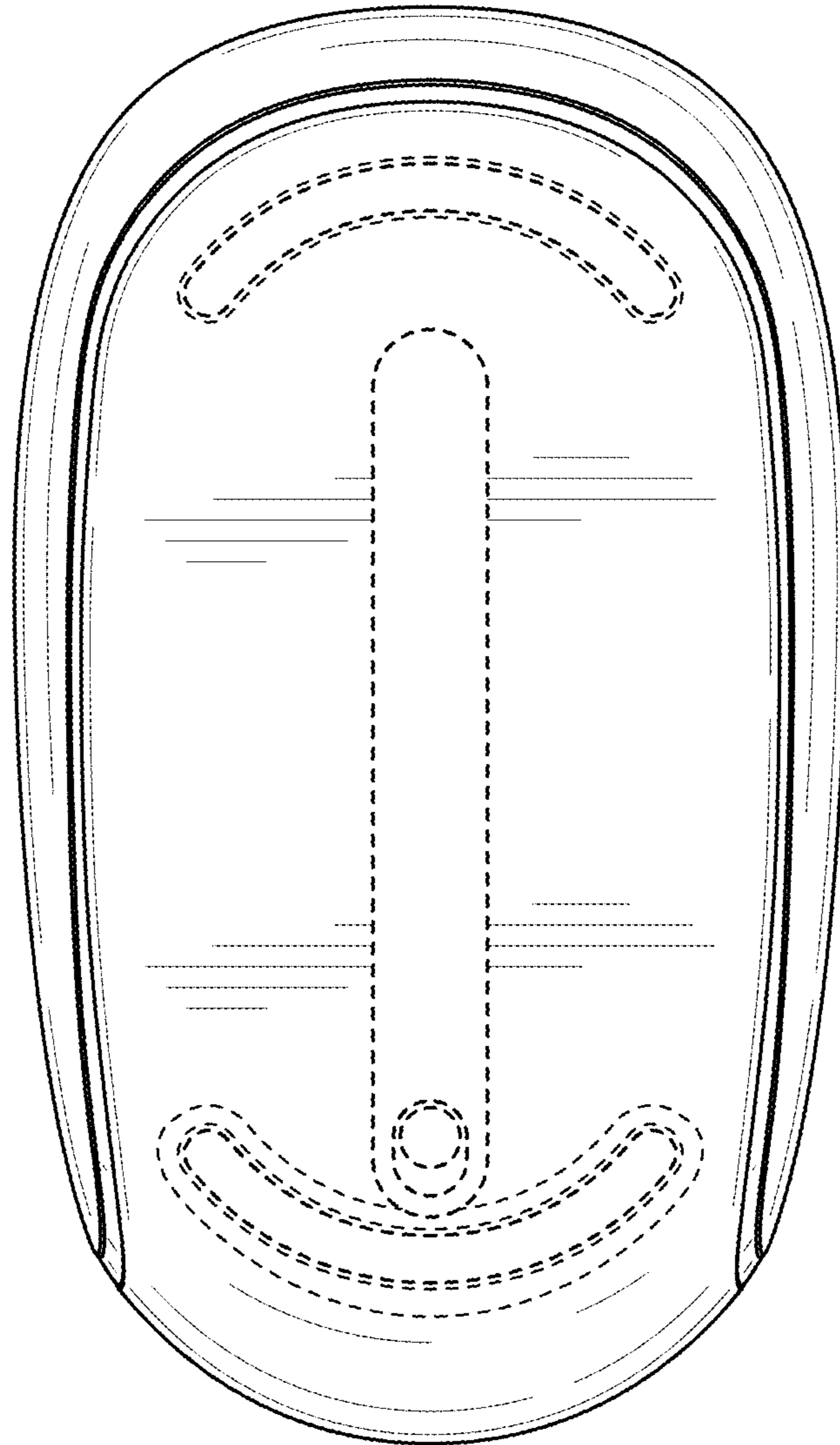

FIG. 7