



US00D725058S

(12) **United States Design Patent**
Kim et al.

(10) **Patent No.:** **US D725,058 S**
(45) **Date of Patent:** **** *Mar. 24, 2015**

(54) **TELEVISION RECEIVER**

(71) Applicant: **Samsung Electronics Co., Ltd.**,
Suwon-si, Gyeonggi-do (KR)
(72) Inventors: **Eui-Seok Kim**, Sungnam-Si (KR);
Su-An Choi, Seoul (KR)
(73) Assignee: **Samsung Electronics Co., Ltd.**,
Suwon-si (KR)

(*) Notice: This patent is subject to a terminal disclaimer.
(**) Term: **14 Years**

(21) Appl. No.: **29/445,927**
(22) Filed: **Feb. 19, 2013**

(30) **Foreign Application Priority Data**
Dec. 12, 2012 (KR) 30-2012-0060015
(51) **LOC (10) Cl.** **14-03**
(52) **U.S. Cl.**
USPC **D14/126**
(58) **Field of Classification Search**
None
See application file for complete search history.

(56) **References Cited**

U.S. PATENT DOCUMENTS

D655,266 S *	3/2012	Kim	D14/126
D655,684 S *	3/2012	Kim et al.	D14/126
D699,205 S *	2/2014	Kim et al.	D14/126
D703,626 S *	4/2014	Hermansen	D14/126

* cited by examiner

Primary Examiner — Raphael Barkai
(74) *Attorney, Agent, or Firm* — NSIP Law

(57) **CLAIM**

The ornamental design for a television receiver, as shown and described.

DESCRIPTION

FIG. 1 is a front perspective view of a television receiver; FIG. 2 is a front view of the television receiver of FIG. 1; FIG. 3 is a rear view of the television receiver of FIG. 1; FIG. 4 is a left-side view of the television receiver of FIG. 1; FIG. 5 is a right-side view of the television receiver of FIG. 1; FIG. 6 is a top plan view of the television receiver of FIG. 1; FIG. 7 is a bottom plan view of the television receiver of FIG. 1; and, FIG. 8 is a rear perspective view of the television receiver of FIG. 1. Features shown in broken lines in FIGS. 1, 2, 3, 4, 5, and 7, form no part of the claimed design.

1 Claim, 7 Drawing Sheets

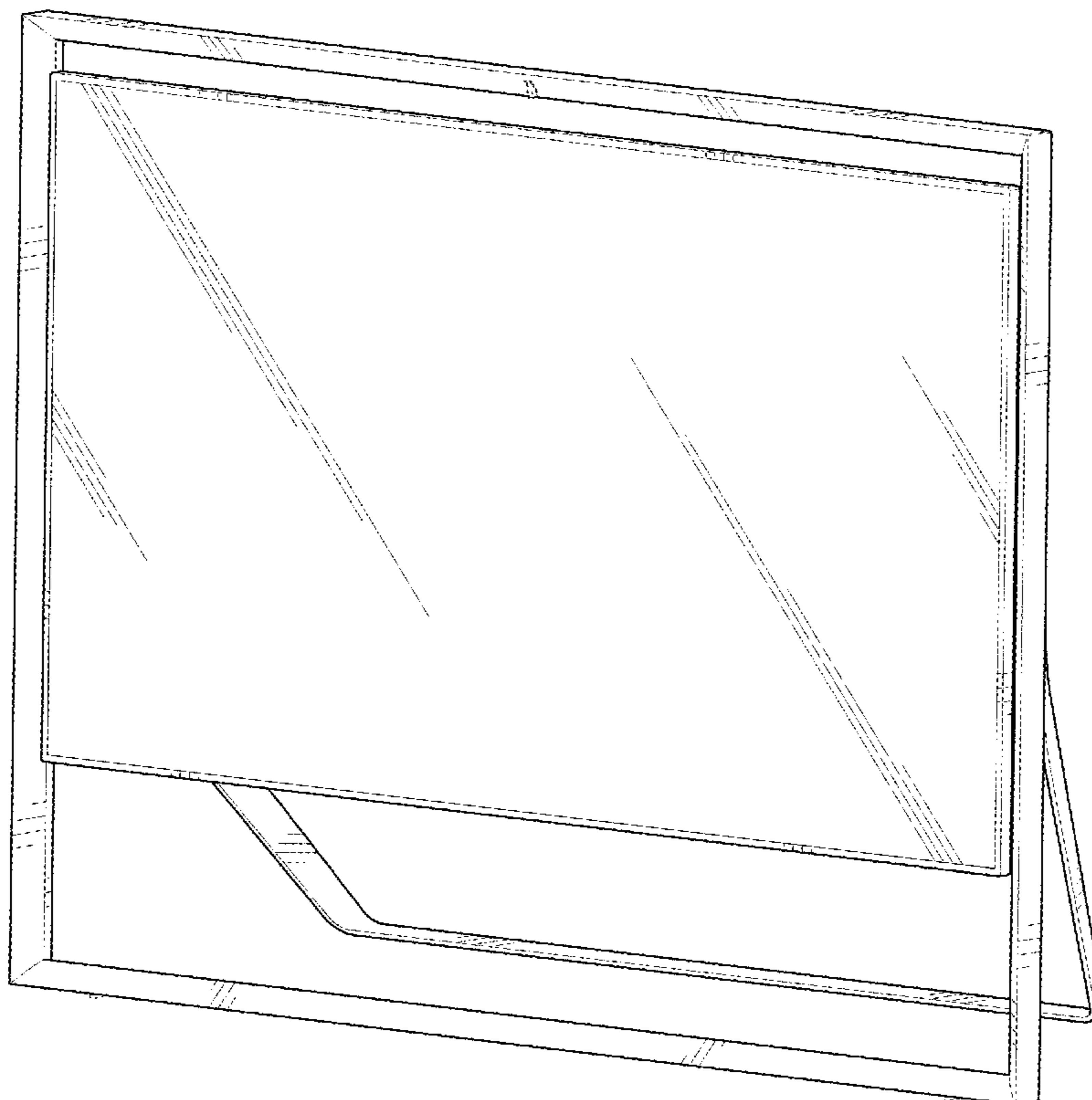

FIG. 1

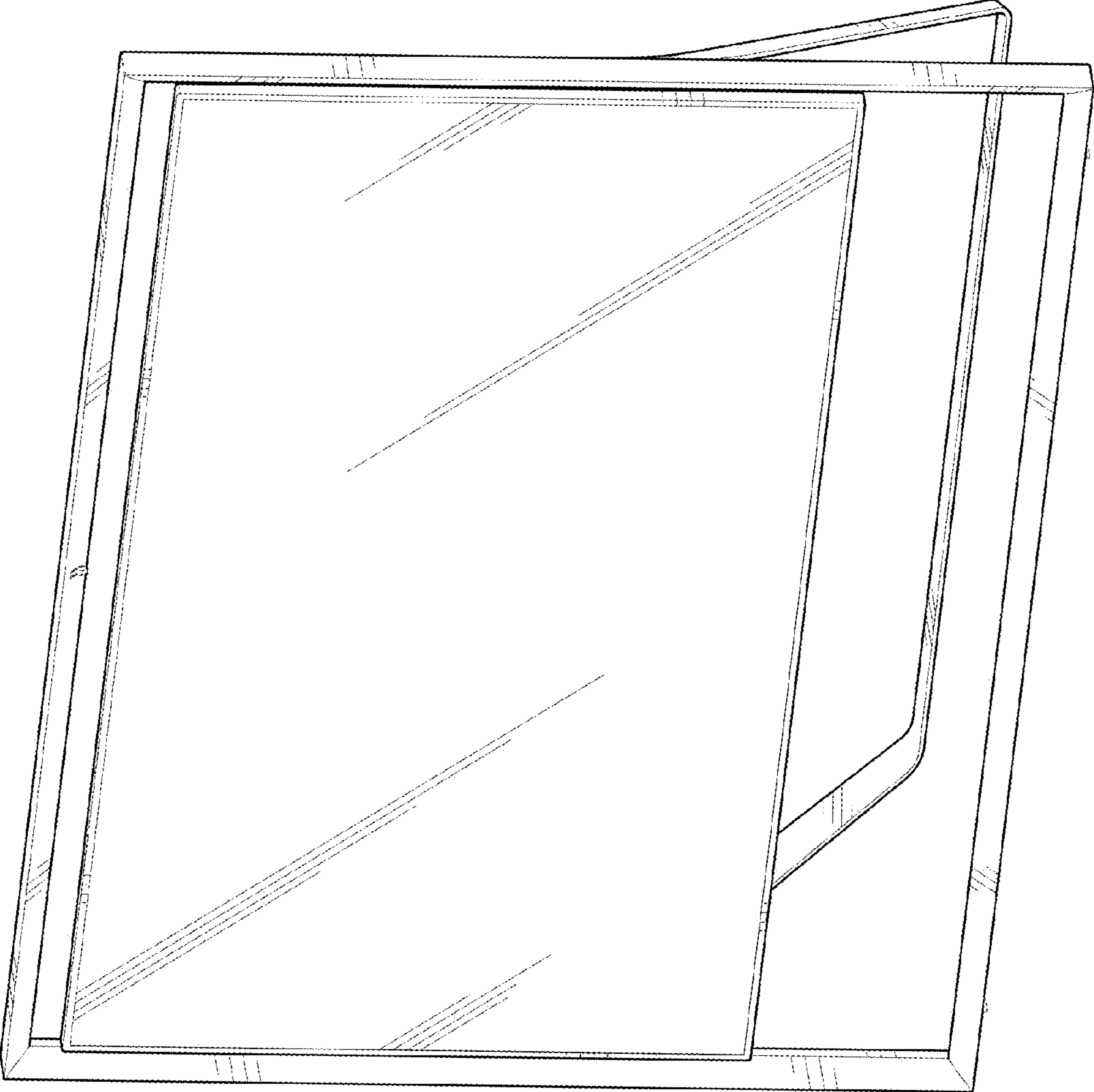

FIG. 2

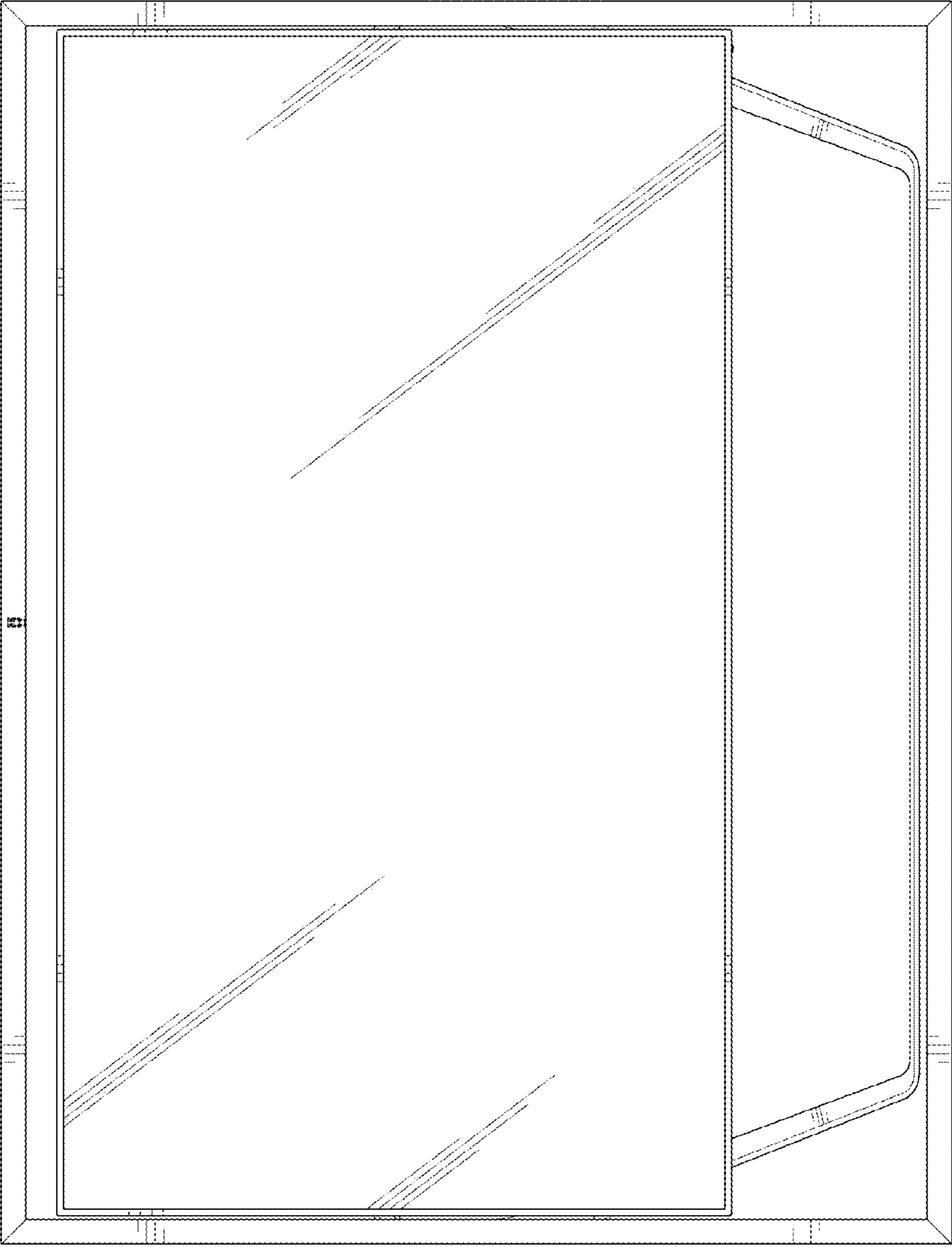

FIG. 3

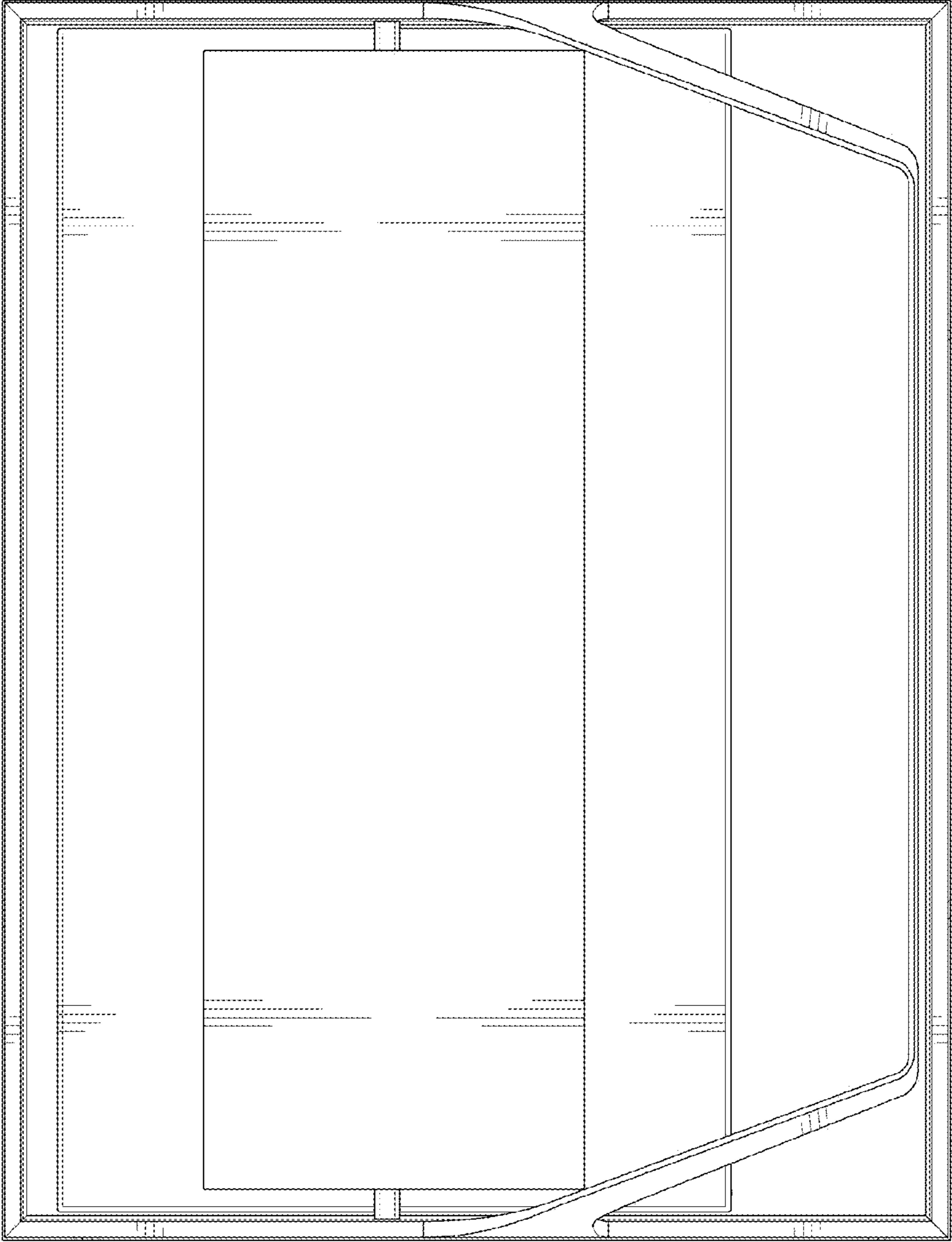

FIG. 5

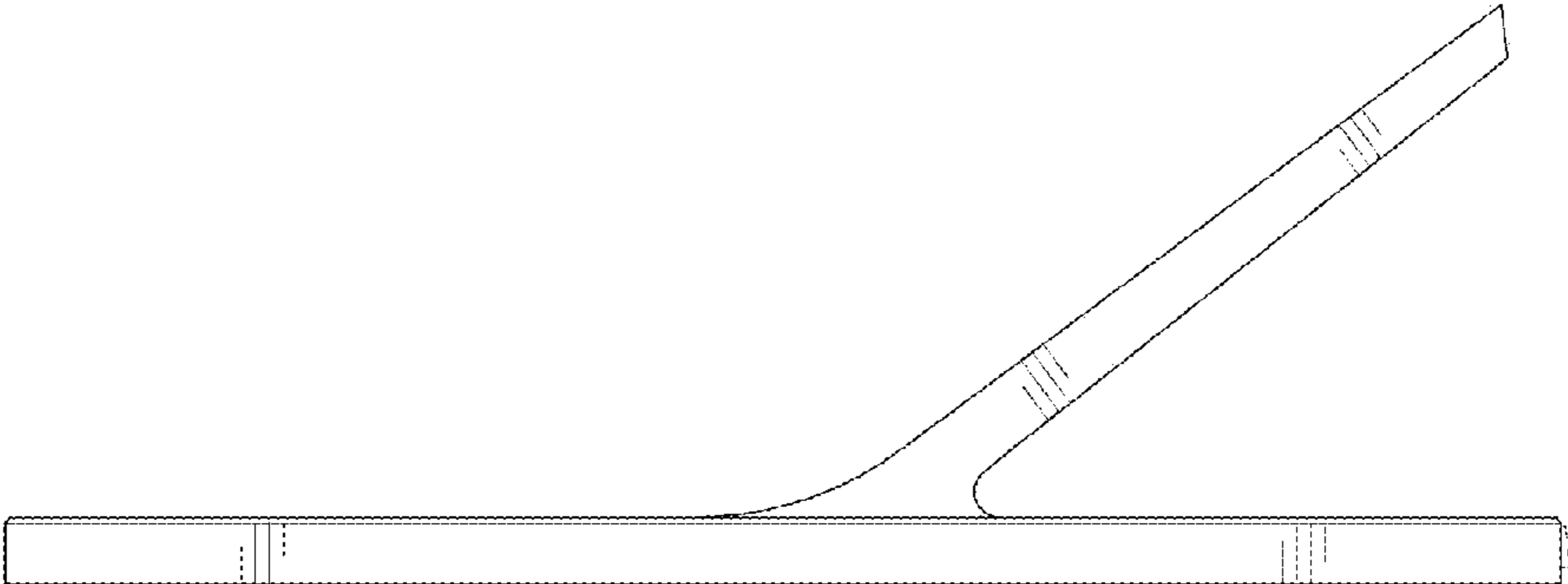

FIG. 4

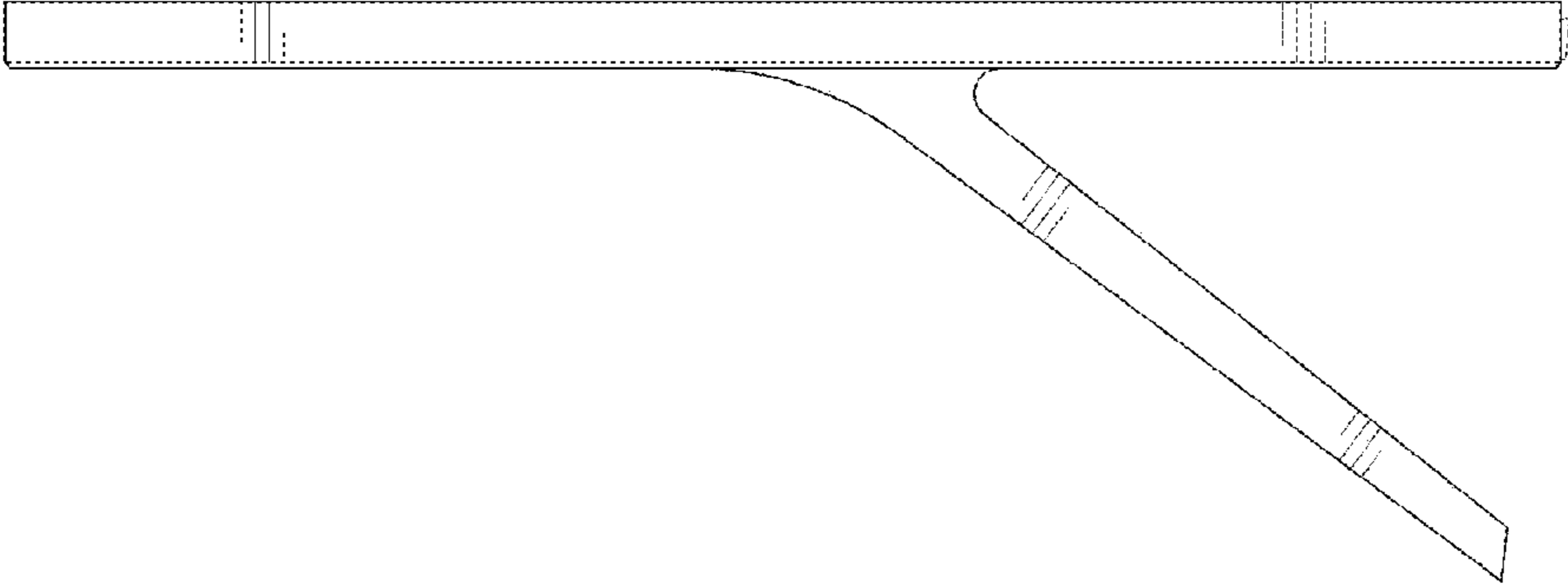

FIG. 6

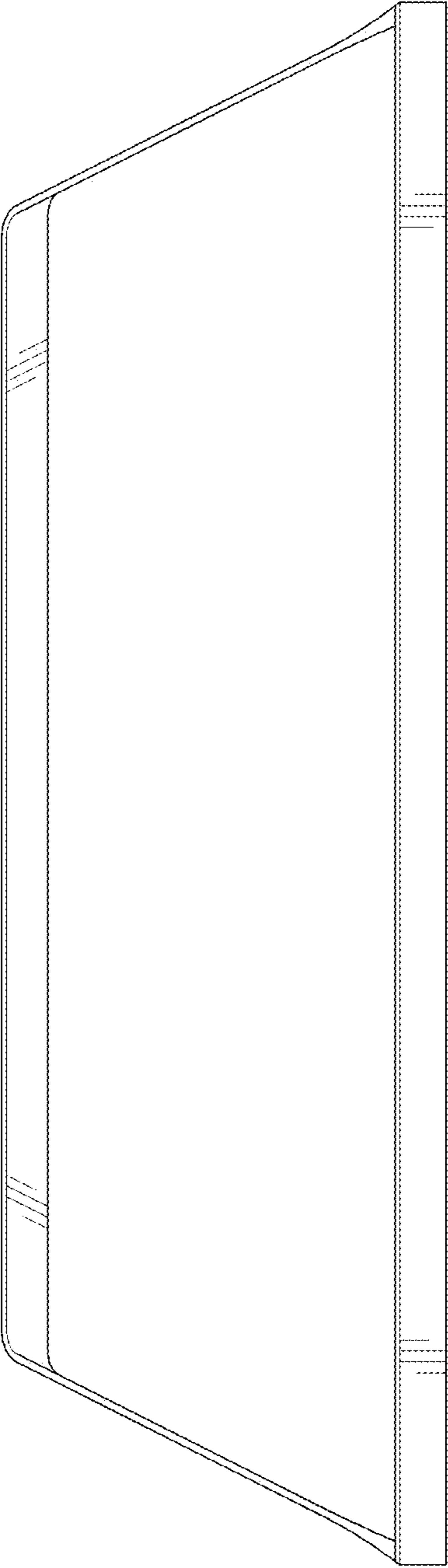

FIG. 7

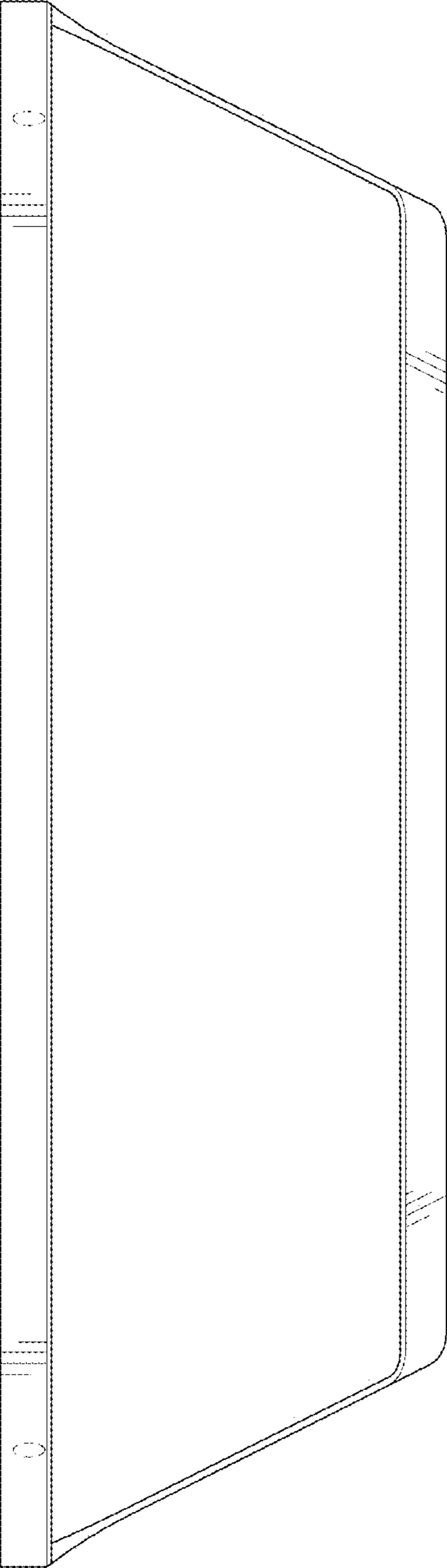

FIG. 8

