



US00D725052S

(12) **United States Design Patent**  
**Chen et al.**

(10) **Patent No.:** **US D725,052 S**

(45) **Date of Patent:** **\*\* Mar. 24, 2015**

(54) **LIGHT-EMITTING DIODE DEVICE**

(71) Applicant: **Epistar Corporation**, Hsinchu (TW)

(72) Inventors: **Chao Hsing Chen**, Hsinchu (TW); **Tsun Kai Ko**, Hsinchu (TW); **Chien Fu Shen**, Hsinchu (TW); **Jia Kuen Wang**, Hsinchu (TW); **Chien Chih Liao**, Hsinchu (TW)

(73) Assignee: **Epistar Corporation**, Hsinchu (TW)

(\*\*) Term: **14 Years**

(21) Appl. No.: **29/489,451**

(22) Filed: **Apr. 30, 2014**

(51) **LOC (10) Cl.** ..... **13-03**

(52) **U.S. Cl.**  
USPC ..... **D13/180**

(58) **Field of Classification Search**

CPC ... H01L 25/167; H01L 25/0753; H01L 27/15;  
H01L 27/156; H01L 31/02; H01L 33/00;  
H01L 33/04; H01L 33/08; H01L 33/10;  
H01L 33/20; H01L 33/38; H01L 33/42;  
H01L 33/48; H01L 33/483; H01L 33/486  
USPC ..... D13/180; D26/1; 257/79, 80, 81, 88,  
257/89, 95, 98, 99, 100, E33.058; 313/483,  
313/498, 500; 362/555, 800

See application file for complete search history.

(56) **References Cited**

**U.S. PATENT DOCUMENTS**

8,093,605	B2 *	1/2012	Kamei	.....	257/98
8,120,057	B2 *	2/2012	Sano et al.	.....	257/99
8,168,995	B2 *	5/2012	Ko et al.	.....	257/99
D674,356	S *	1/2013	Inoue et al.	.....	D13/180
8,436,369	B2 *	5/2013	Seo et al.	.....	257/79
D698,743	S *	2/2014	Hon et al.	.....	D13/180
8,704,249	B2 *	4/2014	Kamiya et al.	.....	257/91
8,823,039	B2 *	9/2014	Shen et al.	.....	257/99
8,884,328	B2 *	11/2014	Lim et al.	.....	257/99
2011/0121329	A1 *	5/2011	Chen et al.	.....	257/91

2014/0209938 A1\* 7/2014 Emura et al. .... 257/88

\* cited by examiner

*Primary Examiner* — Selina Sikder

(74) *Attorney, Agent, or Firm* — Muncy, Geissler, Olds & Lowe P.C.

(57) **CLAIM**

The ornamental design for a light-emitting diode device, as shown and described.

**DESCRIPTION**

FIG. 1 is a perspective view of a light-emitting diode device showing our first example of the new design; FIG. 2 is another perspective view thereof; FIG. 3 is a front elevational view thereof; FIG. 4 is a rear elevational view thereof; FIG. 5 is a left side view thereof; FIG. 6 is a right side view thereof; FIG. 7 is a top plan view thereof; FIG. 8 is a bottom plan view thereof; FIG. 9 is an enlarged partial view thereof at section A in FIG. 1; FIG. 10 is an enlarged partial view thereof at section B in FIG. 1; FIG. 11 is a perspective view of a light-emitting diode device showing our second example of the new design; FIG. 12 is another perspective view thereof; FIG. 13 is a front elevational view thereof; FIG. 14 is a rear elevational view thereof; FIG. 15 is a left side view thereof; FIG. 16 is a right side view thereof; FIG. 17 is a top plan view thereof; FIG. 18 is a bottom plan view thereof; FIG. 19 is an enlarged partial view thereof at section A in FIG. 11; and, FIG. 20 is an enlarged partial view thereof at section B in FIG. 11.

The broken line showing is for the purpose of illustrating environmental structure only and forms no part of the claimed design.

**1 Claim, 16 Drawing Sheets**

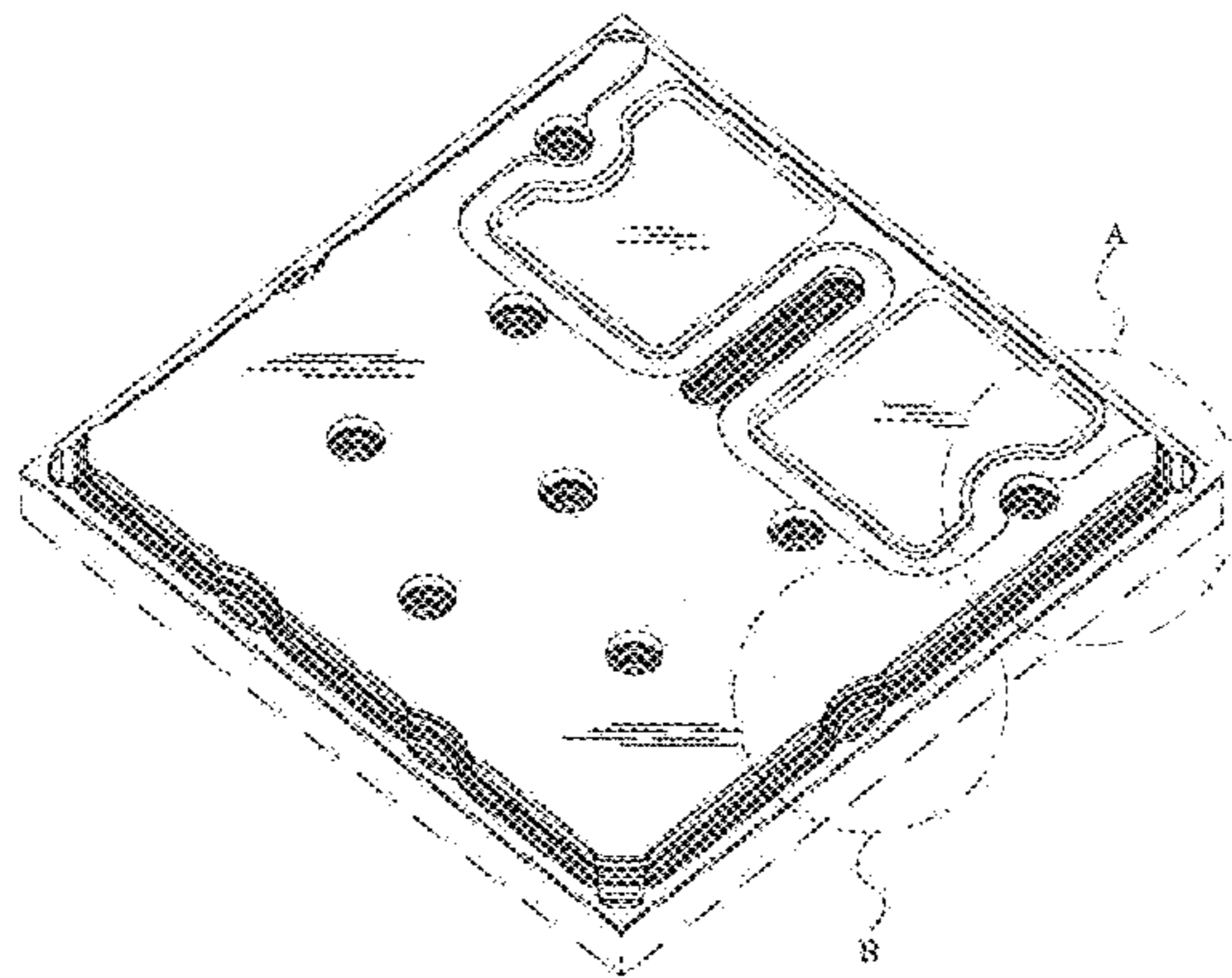

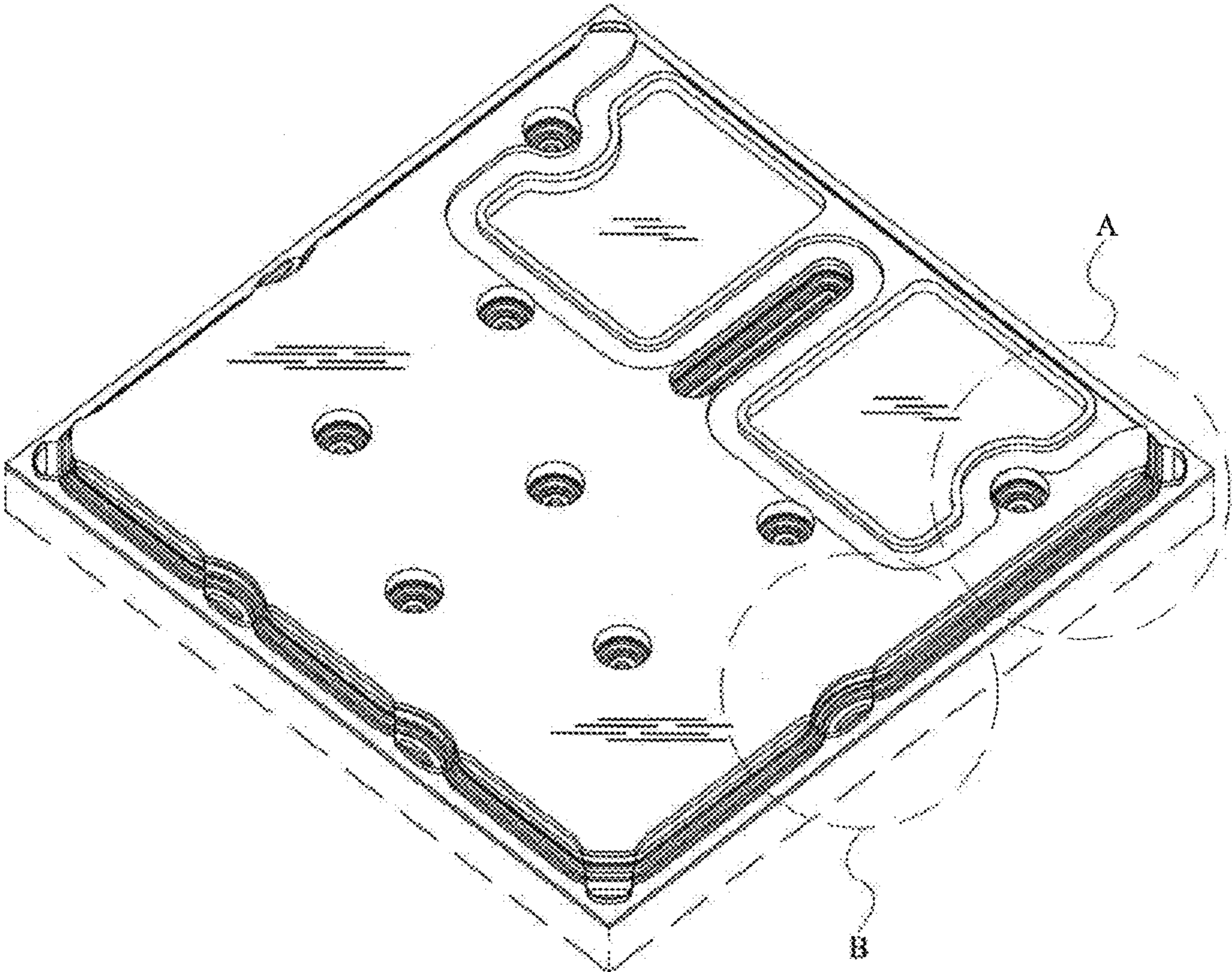

FIG.1

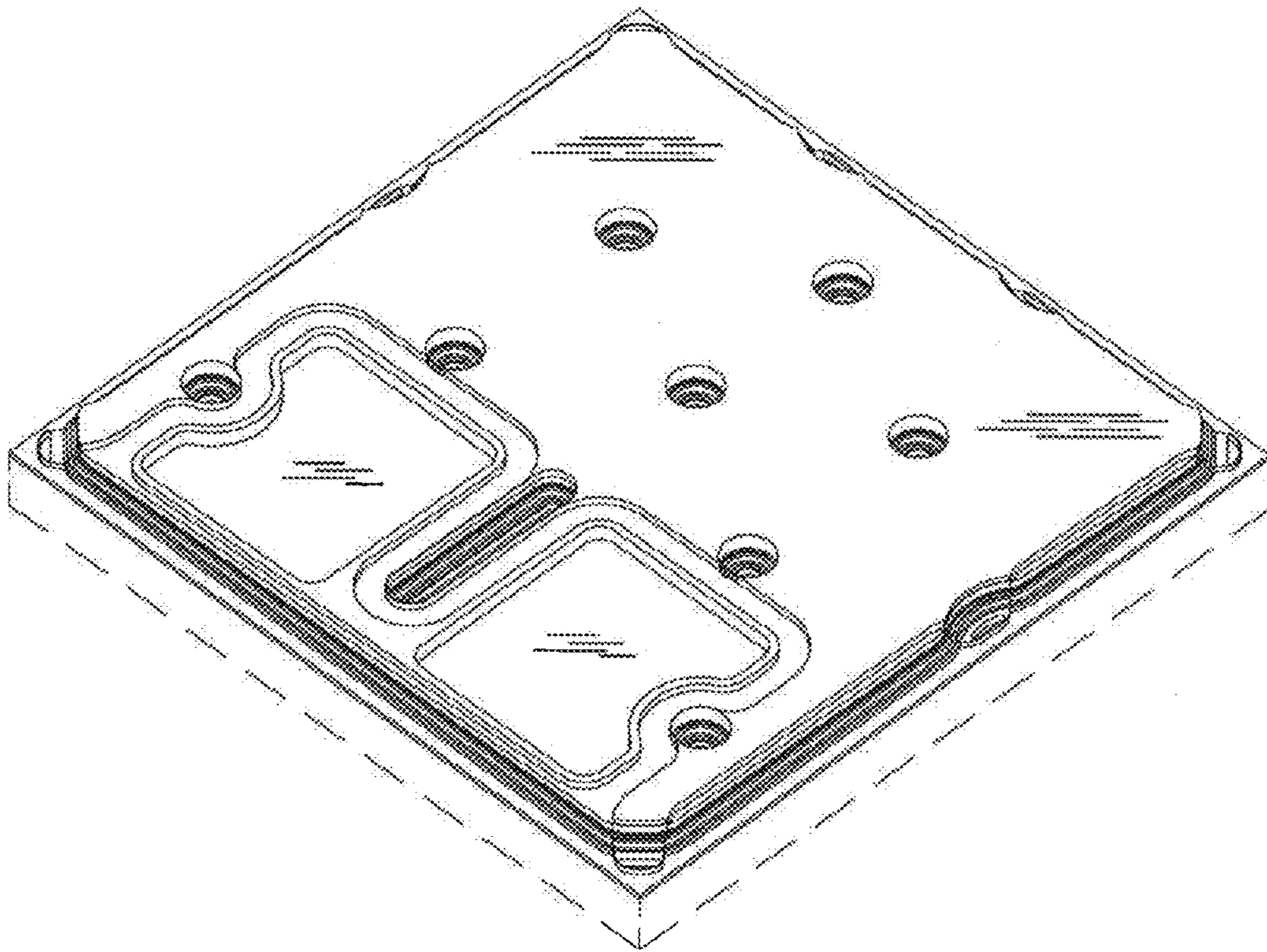

FIG.2

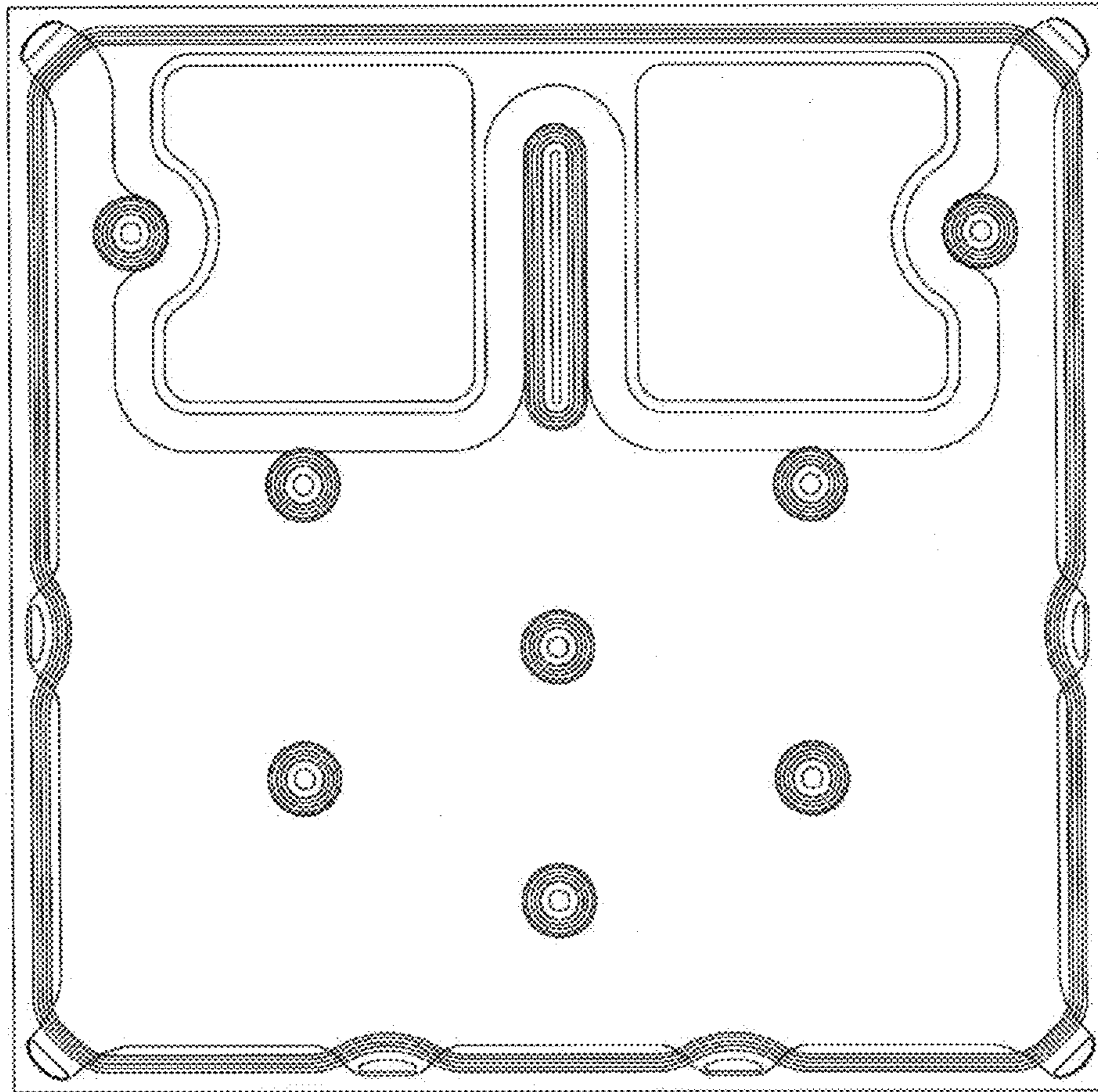

FIG.3

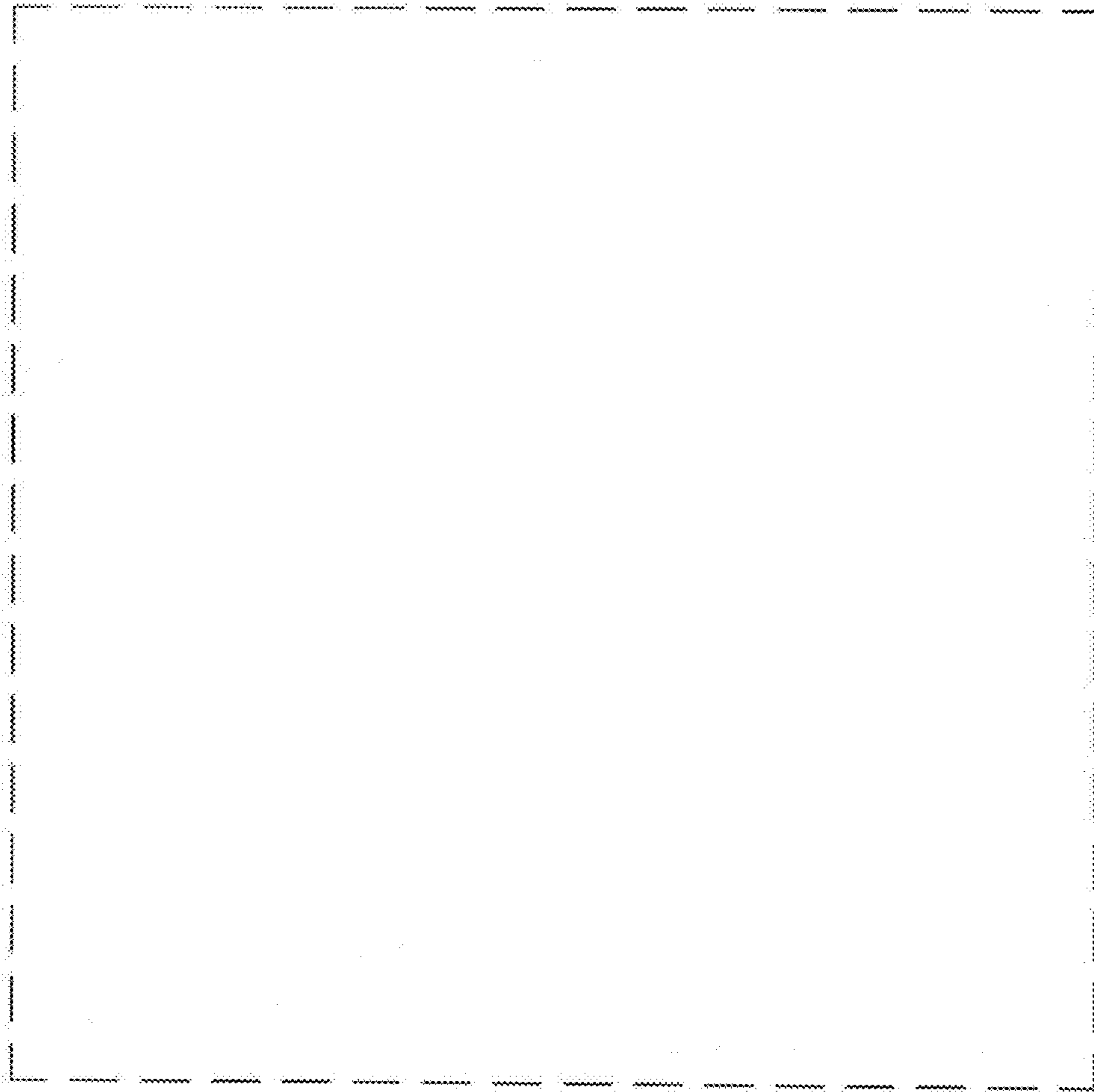

FIG.4

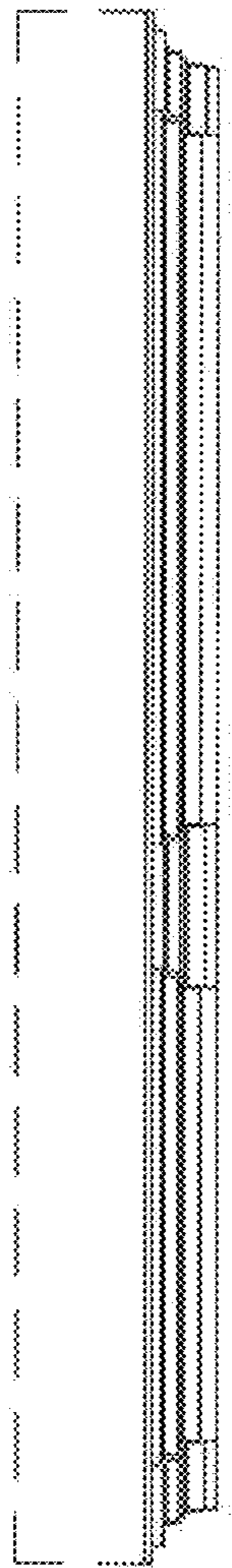

FIG. 5

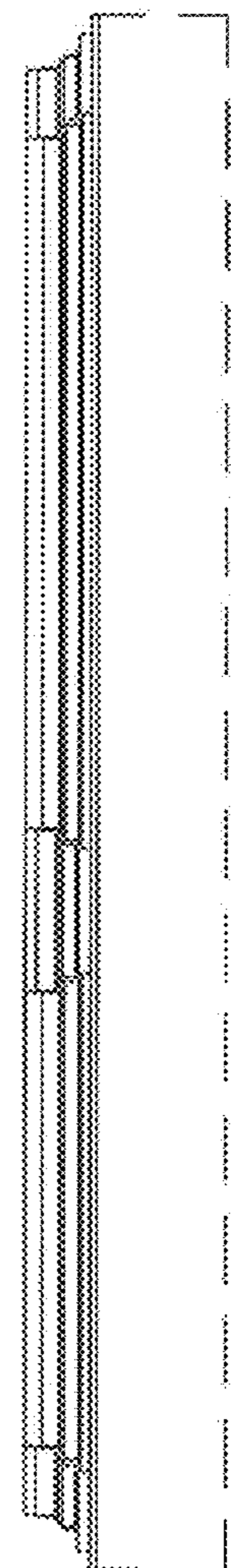

FIG. 6

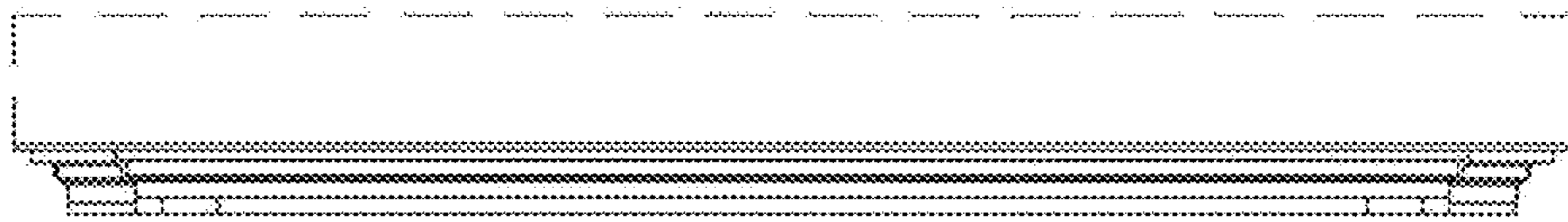

FIG. 7

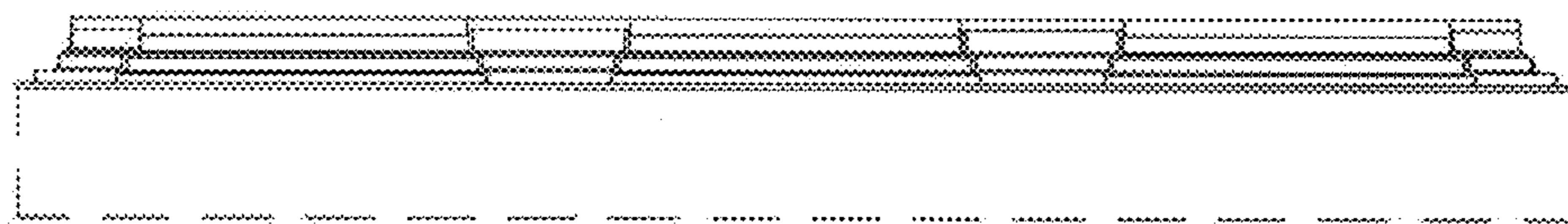

FIG. 8

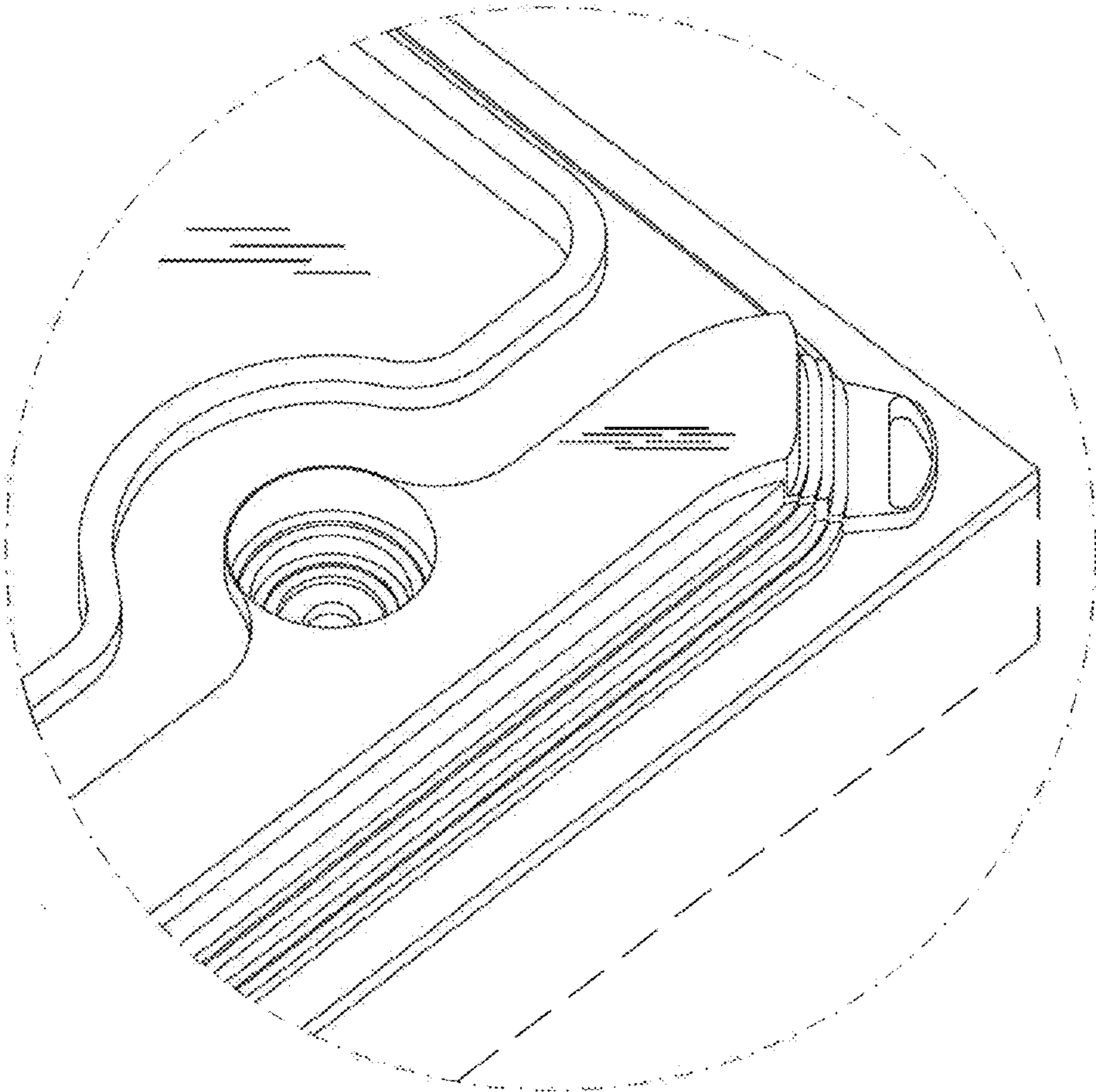

FIG.9



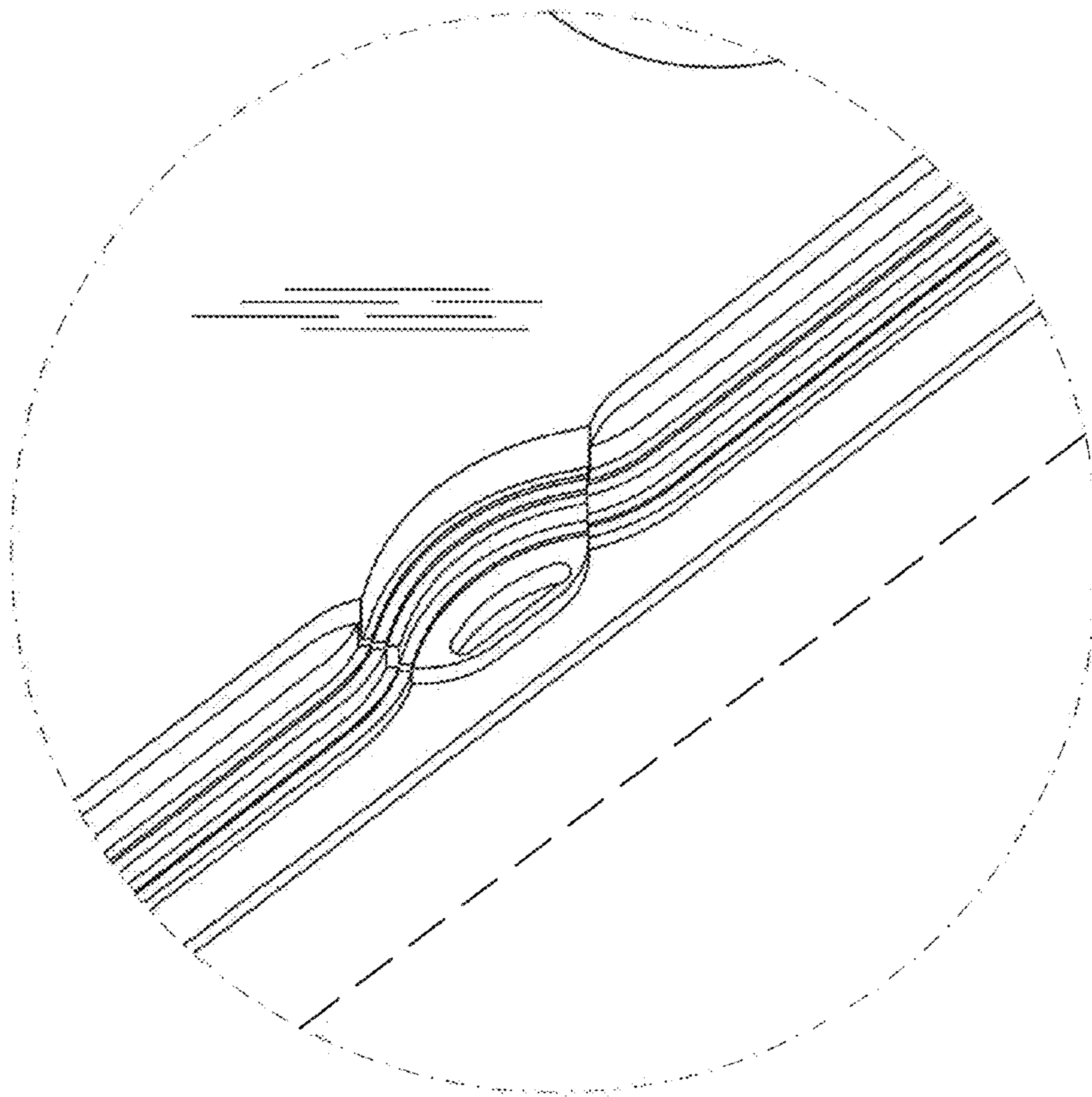

FIG.10

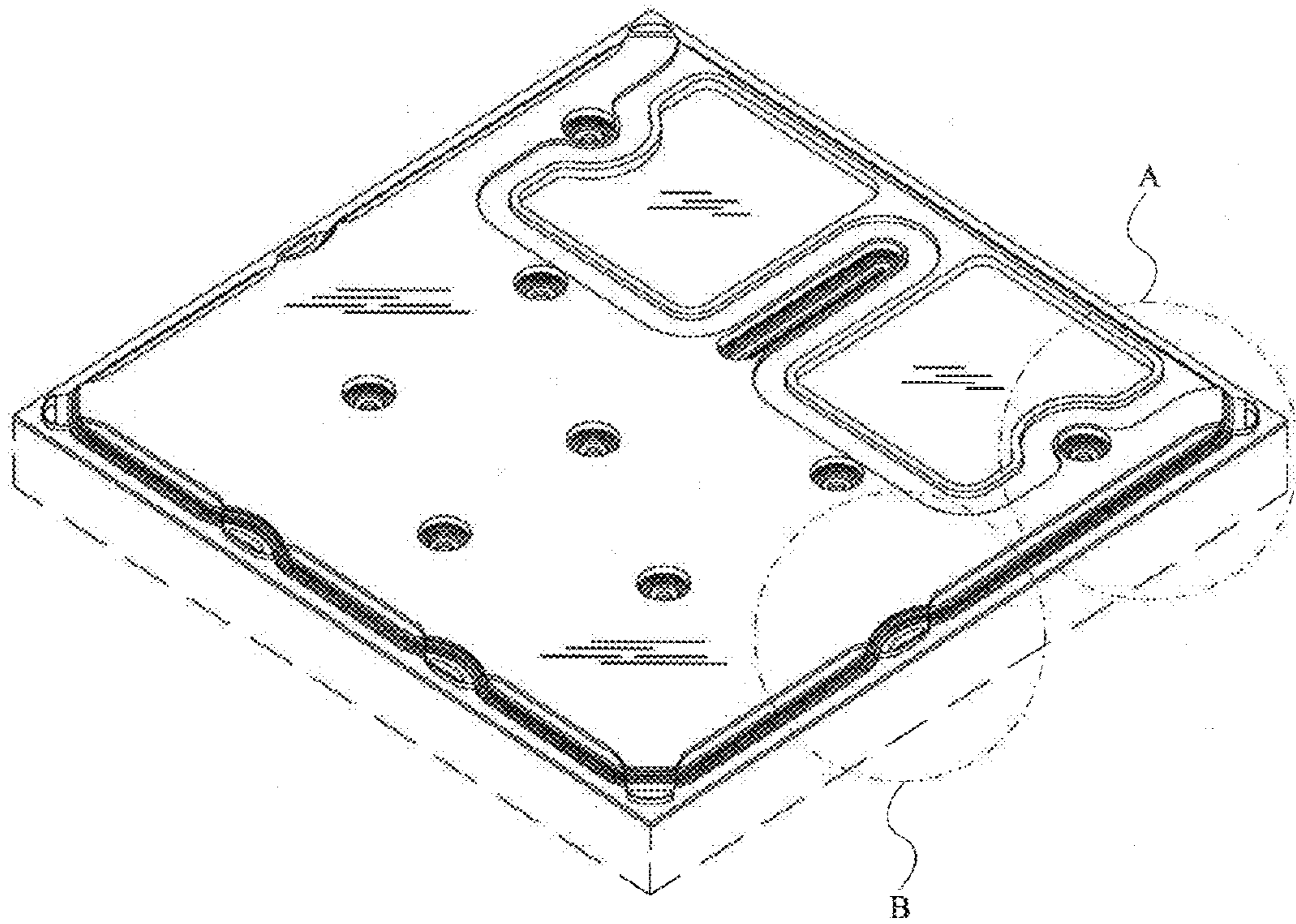

FIG.11

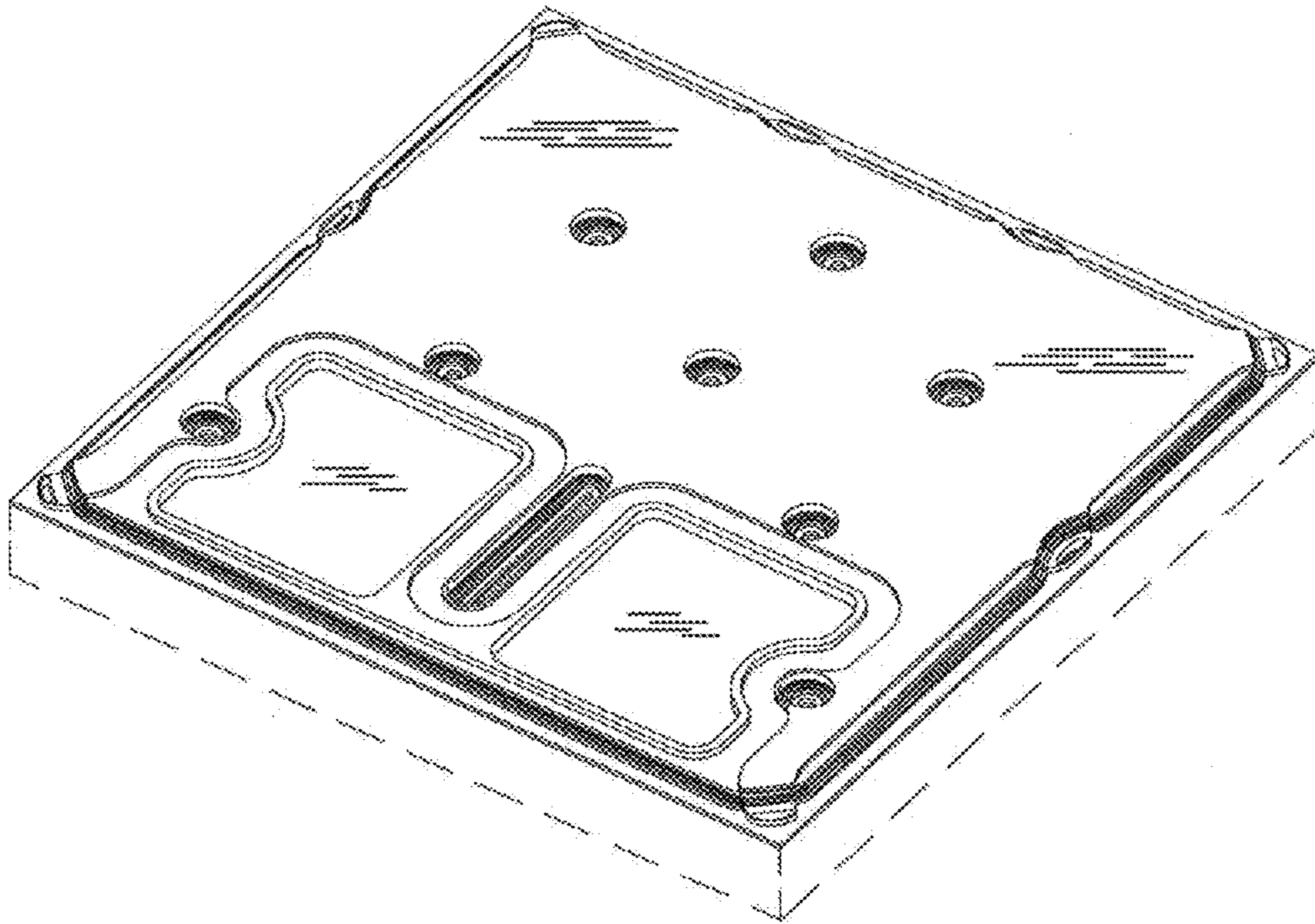

FIG.12

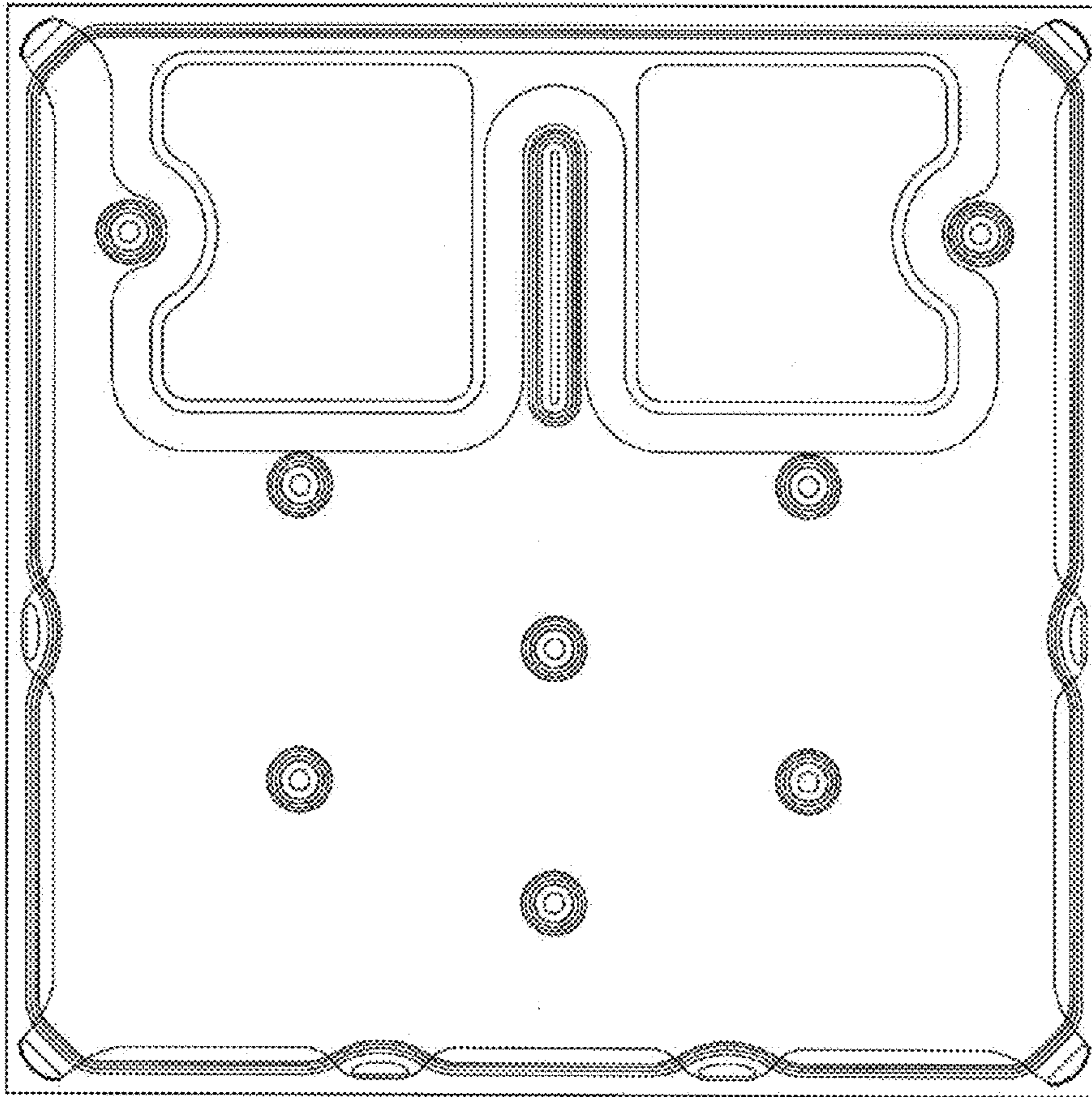

FIG.13

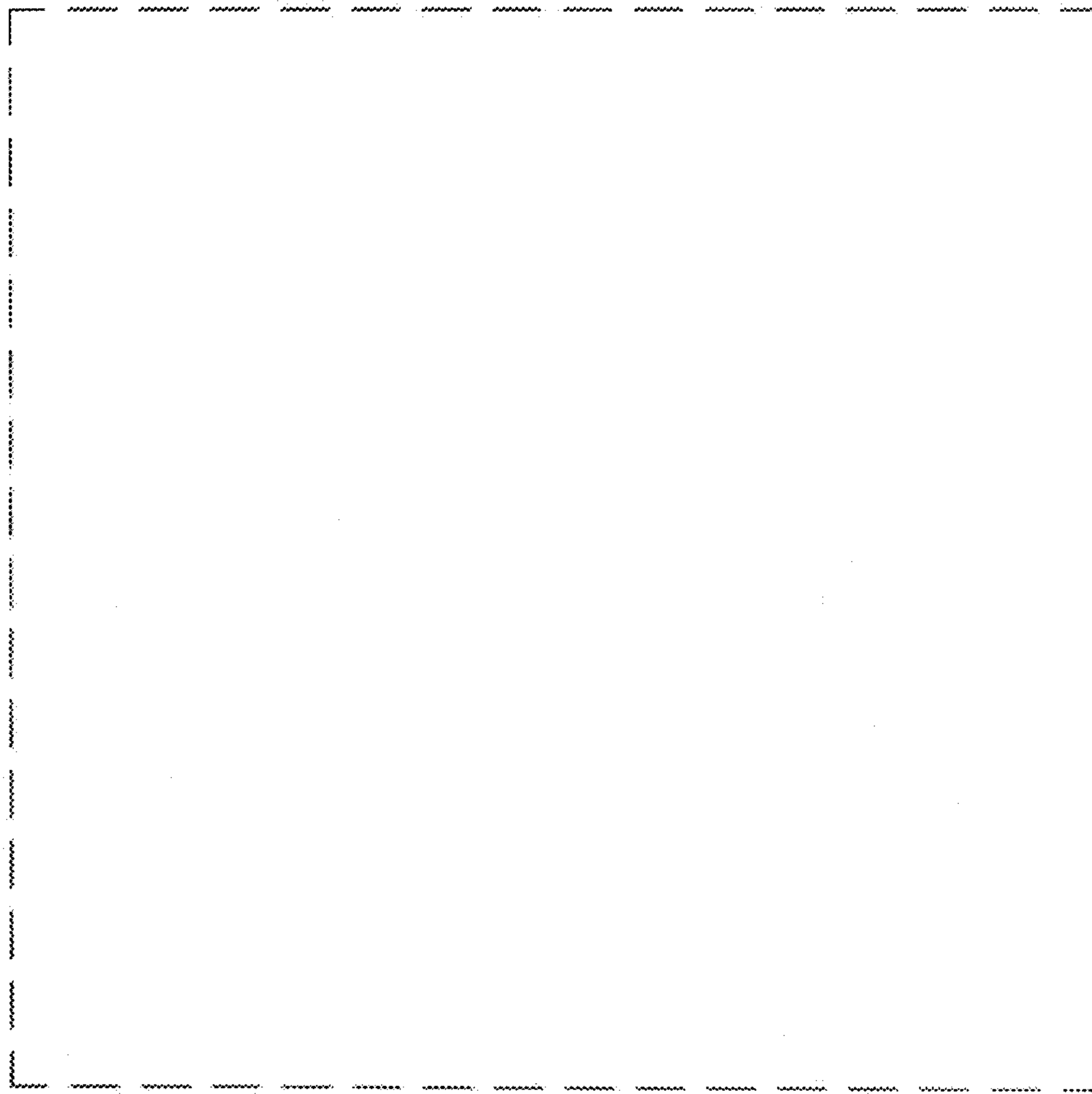

FIG.14

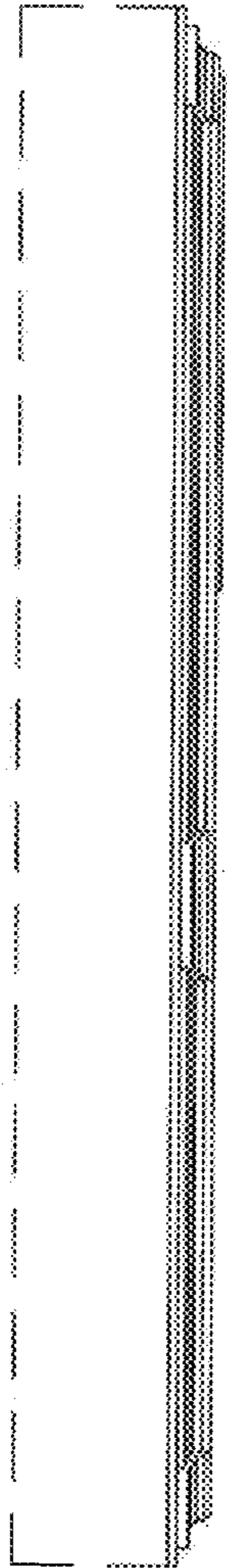

FIG. 15

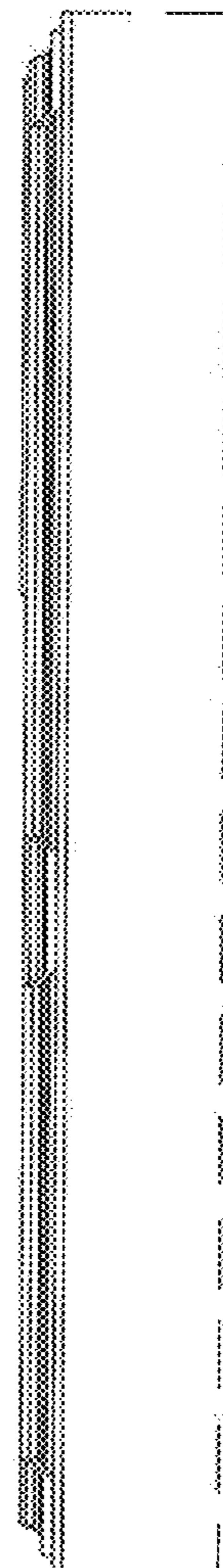

FIG. 16

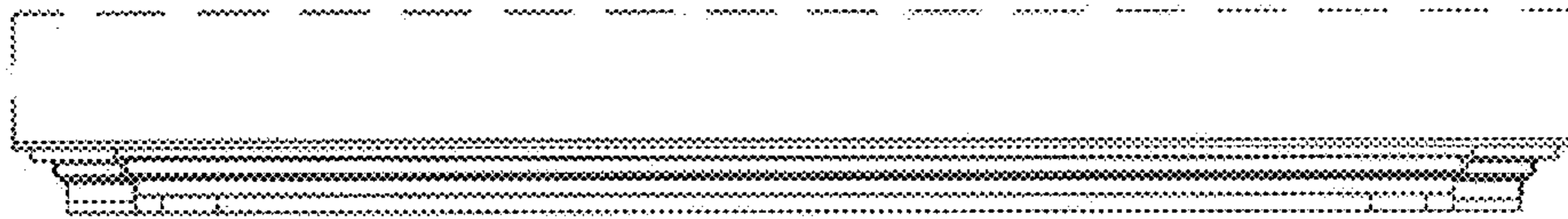

FIG.17

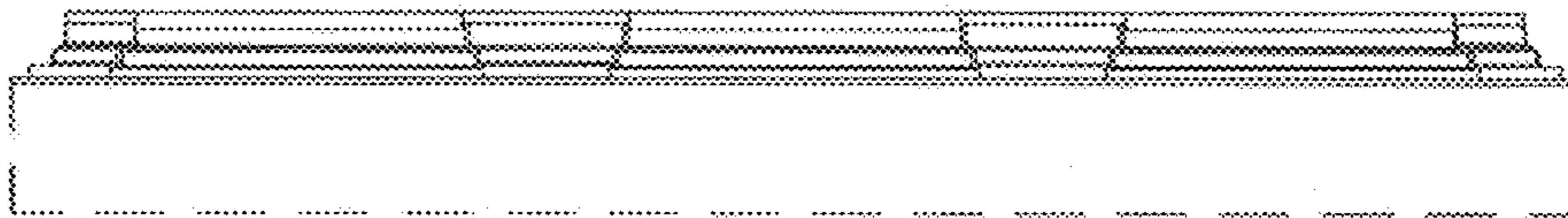

FIG.18

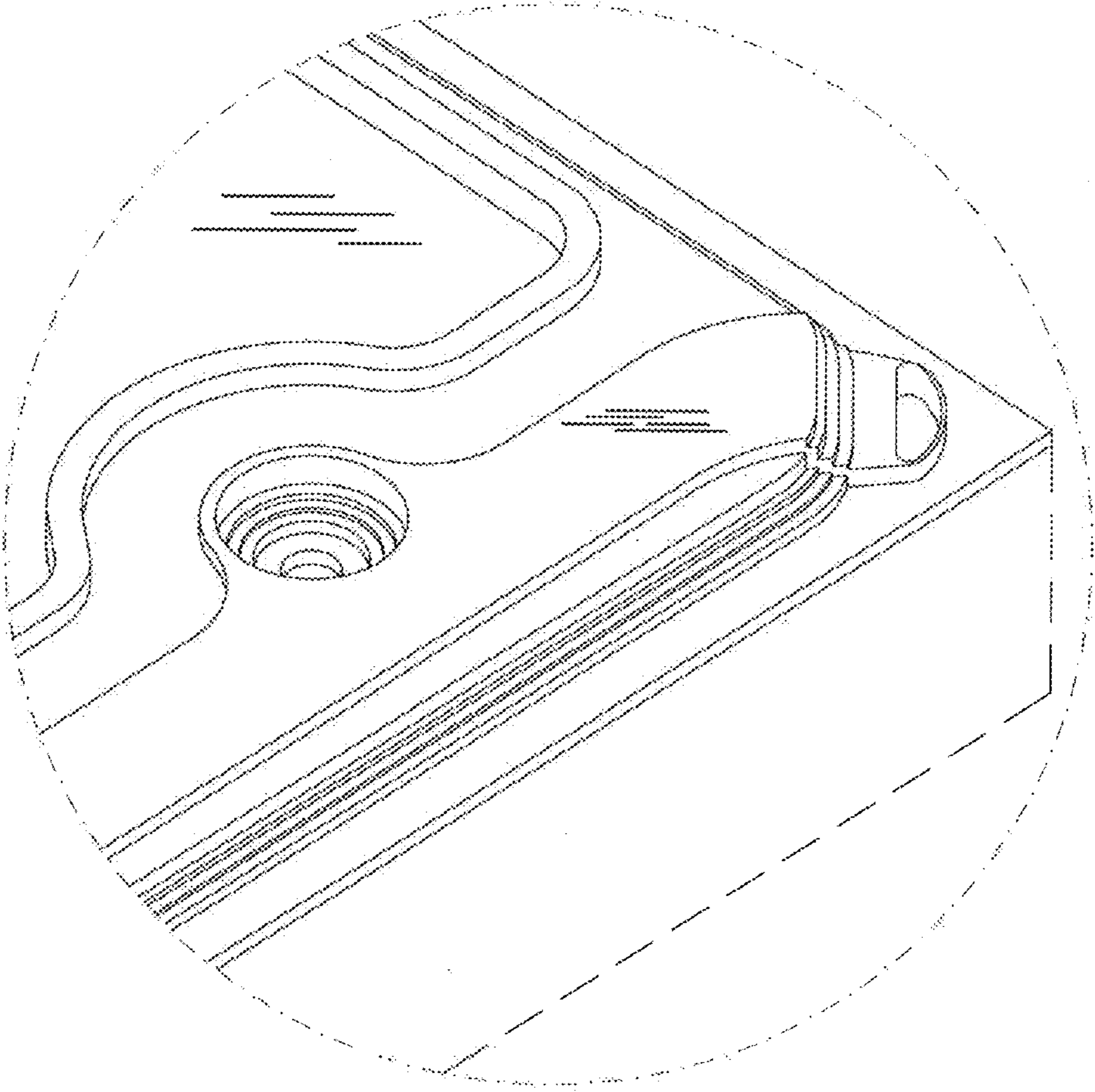

FIG.19



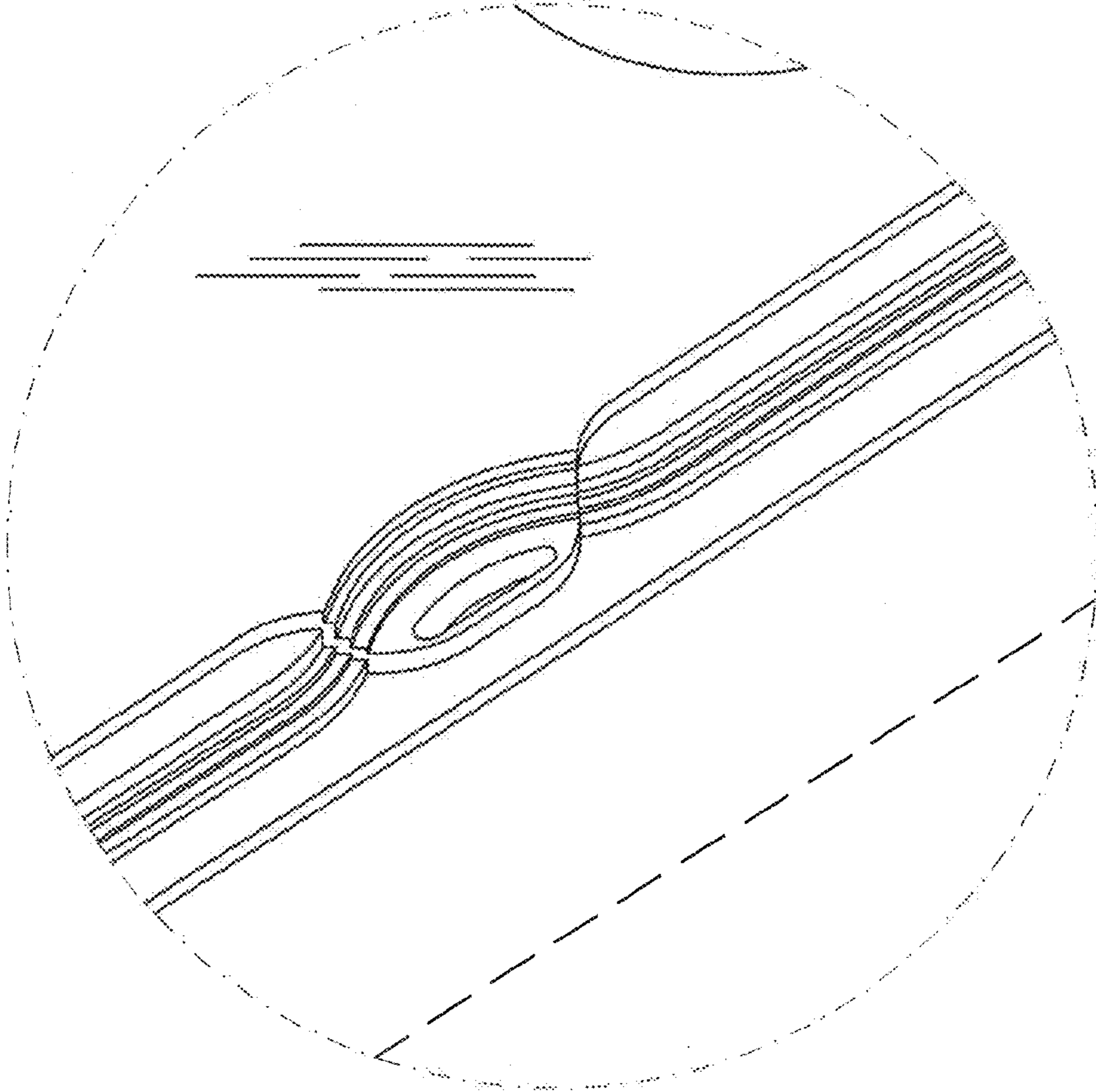

FIG.20