



US00D724994S

(12) **United States Design Patent**  
**Paik et al.**

(10) **Patent No.:** **US D724,994 S**  
(45) **Date of Patent:** **\*\* Mar. 24, 2015**

(54) **BUCKLE FOR BAG**

(71) Applicant: **Woojin Plastic Co., Ltd**, Gyeonggi-do (KR)

(72) Inventors: **Jisook Paik**, Seoul (KR); **Nan Hee Paik**, Seoul (KR); **Ji Hye Paik**, Seoul (KR); **Ji Won Son**, Seoul (KR)

(73) Assignee: **Woojin Plastic Co., Ltd.**, Gyeonggi-do (KR)

(\*\*) Term: **14 Years**

(21) Appl. No.: **29/489,715**

(22) Filed: **May 2, 2014**

(30) **Foreign Application Priority Data**

Feb. 11, 2014 (KR) ..... 30-2014-0006777

(51) **LOC (10) Cl.** ..... **02-07**

(52) **U.S. Cl.**  
USPC ..... **D11/216**

(58) **Field of Classification Search**  
CPC ..... A44B 11/26  
USPC ..... D11/1-2, 200-201, 206-210, 214-218;  
24/163 R, 169-171, 173, 177-179, 191,  
24/194-195, 197, 200, 614-616, 625,  
24/198; D8/349

See application file for complete search history.

(56) **References Cited**

U.S. PATENT DOCUMENTS

D284,900 S \* 8/1986 Chalmers et al. .... D11/200  
D363,690 S \* 10/1995 Gallon et al. .... D11/216  
D684,088 S \* 6/2013 Fukazawa ..... D11/216  
D686,528 S \* 7/2013 Paik et al. .... D11/216

\* cited by examiner

*Primary Examiner* — Ralf Seifert

(74) *Attorney, Agent, or Firm* — Jordan and Hamburg LLP

(57) **CLAIM**

We claim, the ornamental design for a buckle for bag, as shown and described.

**DESCRIPTION**

FIG. 1 is a perspective view of a buckle for bag, showing my new design;  
FIG. 2 is a front elevational view thereof;  
FIG. 3 is a rear elevational view thereof;  
FIG. 4 is a left side elevational view thereof;  
FIG. 5 is a right side elevational view thereof;  
FIG. 6 is a top plan view thereof;  
FIG. 7 is a bottom plan view thereof; and,  
FIG. 8 is an A-A sectional view thereof.

**1 Claim, 2 Drawing Sheets**

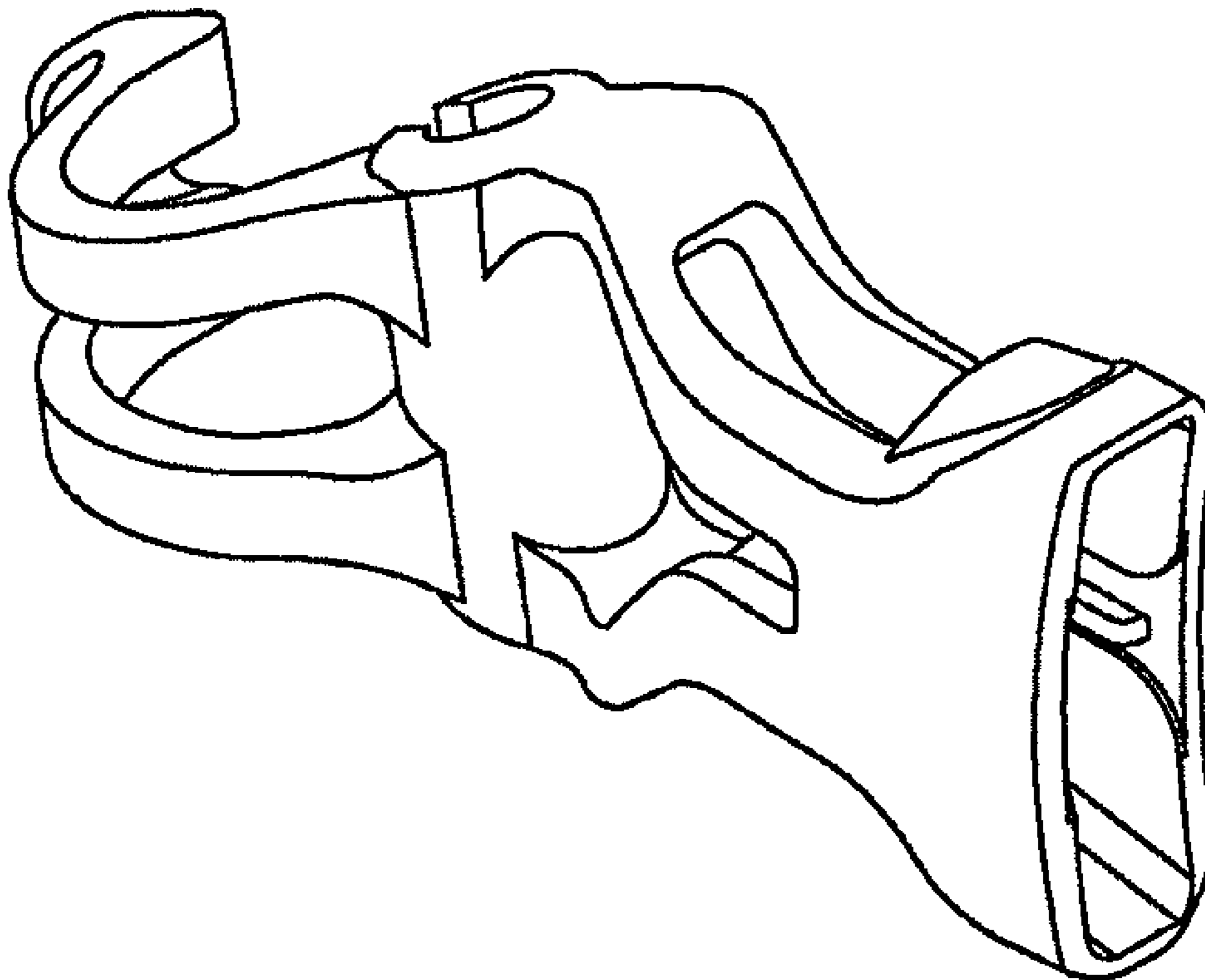

FIG. 1

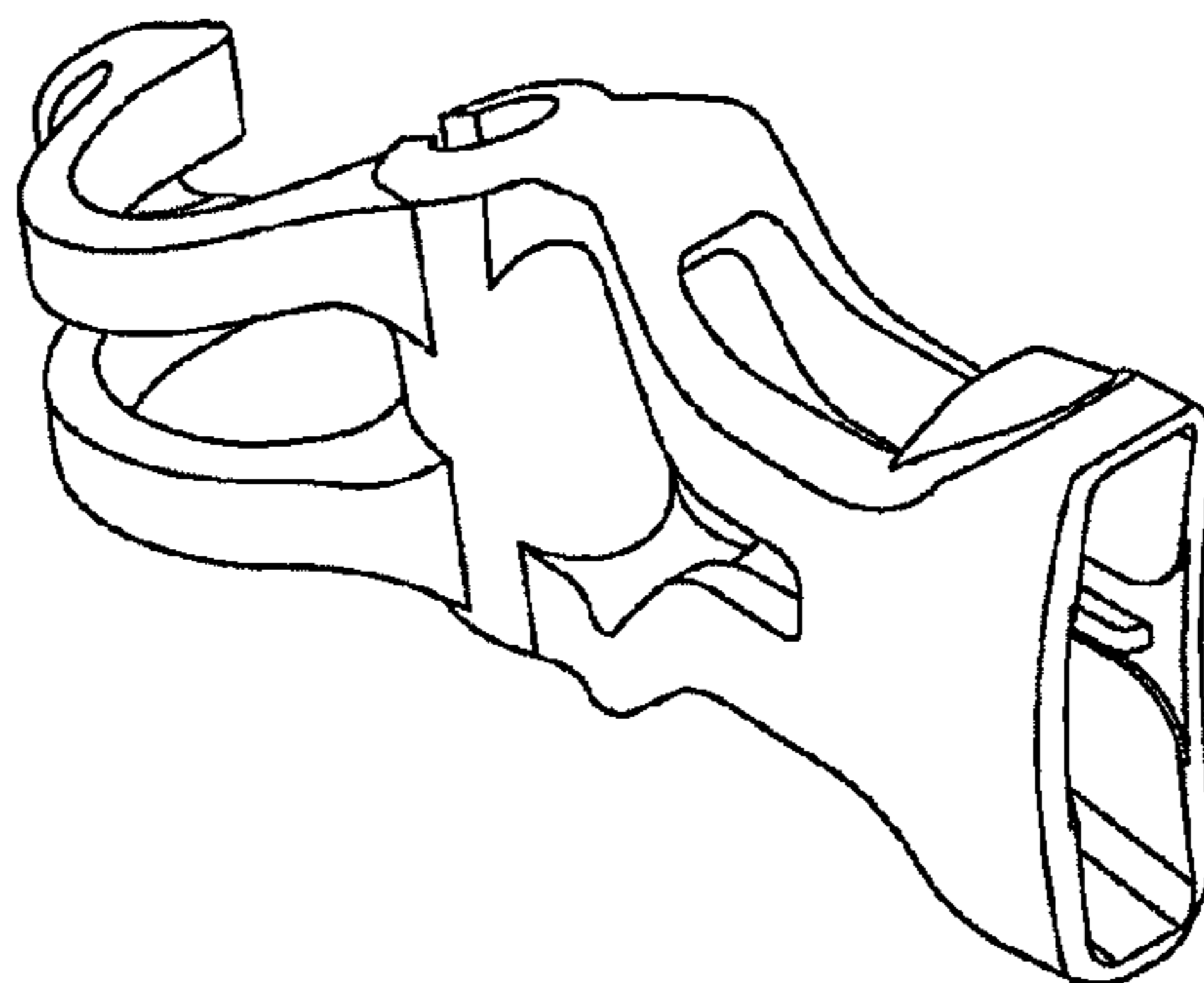

FIG. 2

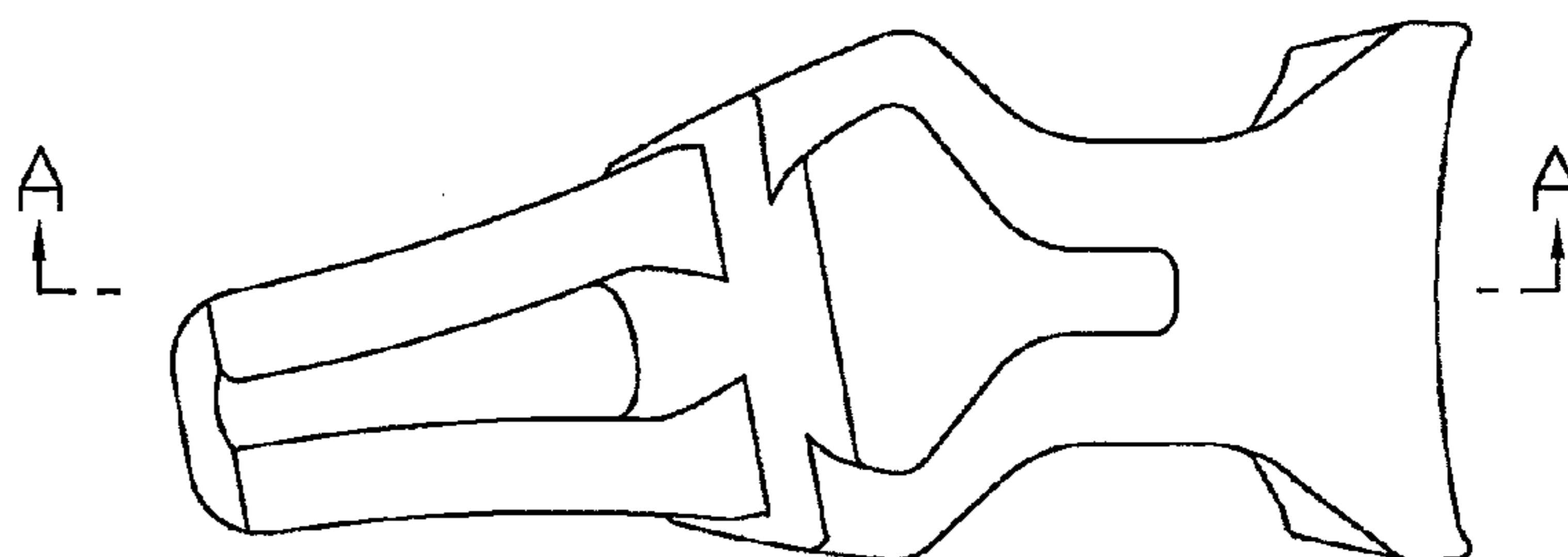

FIG. 3

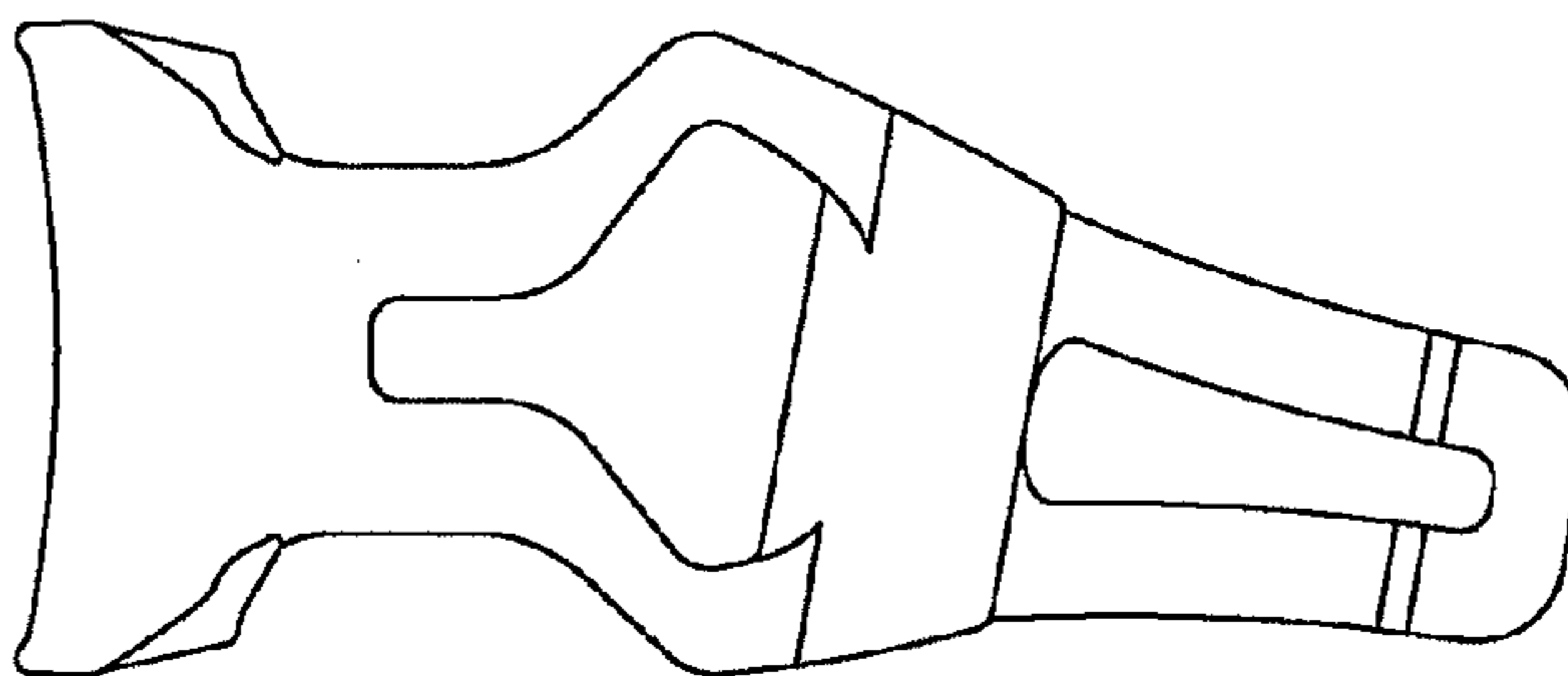

FIG. 4

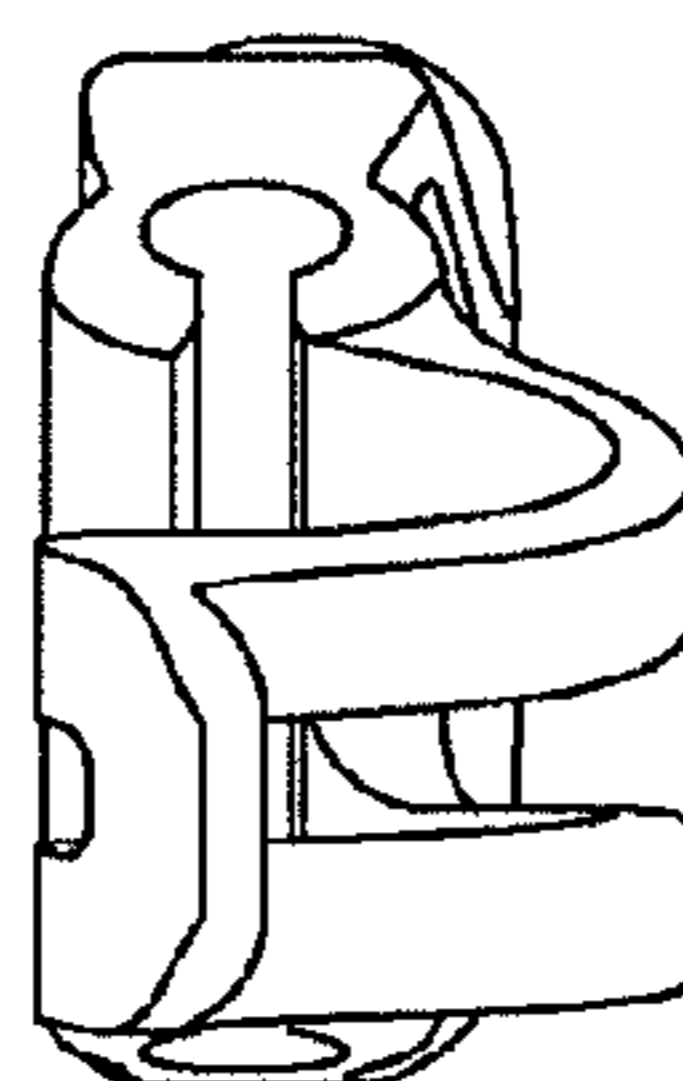

FIG.5

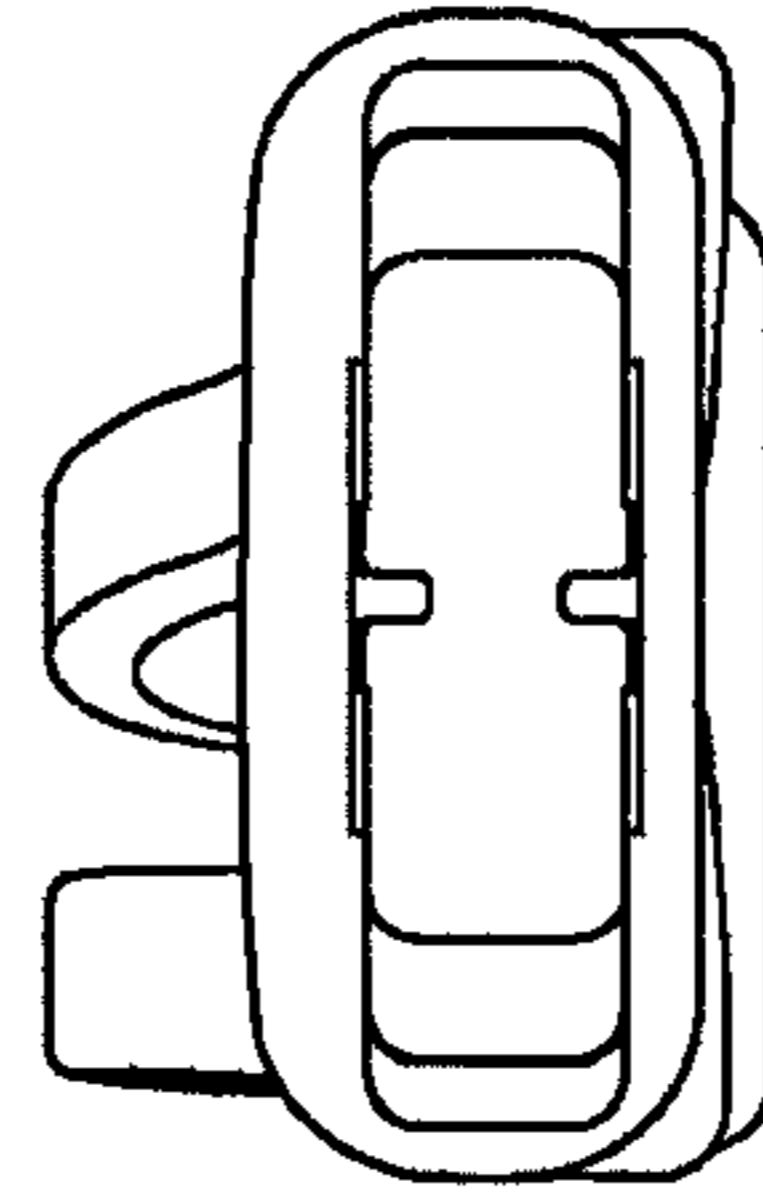

FIG.6

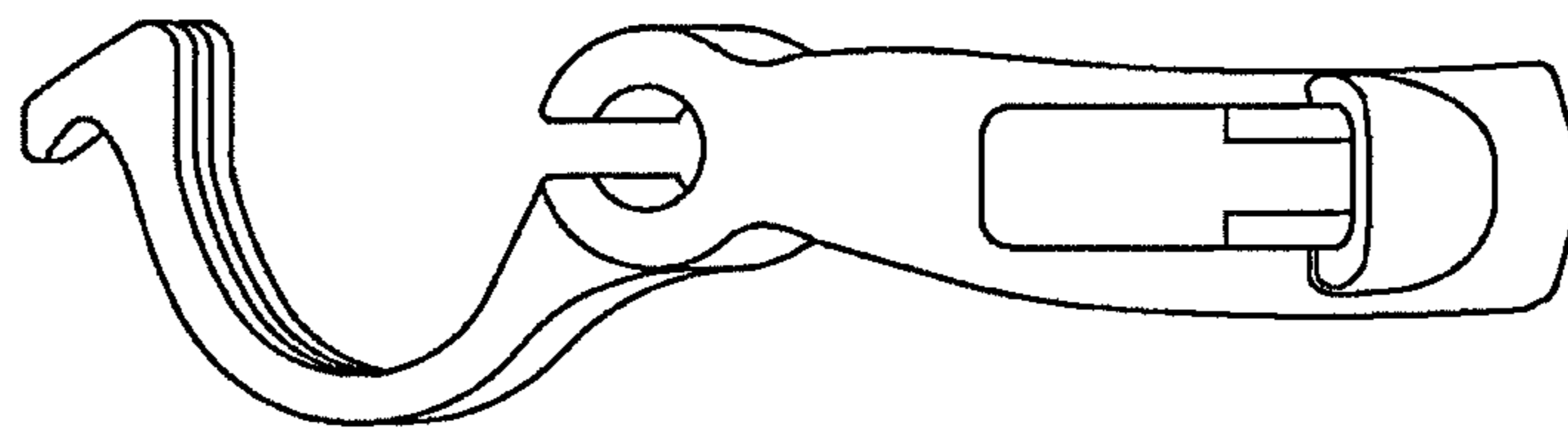

FIG.7

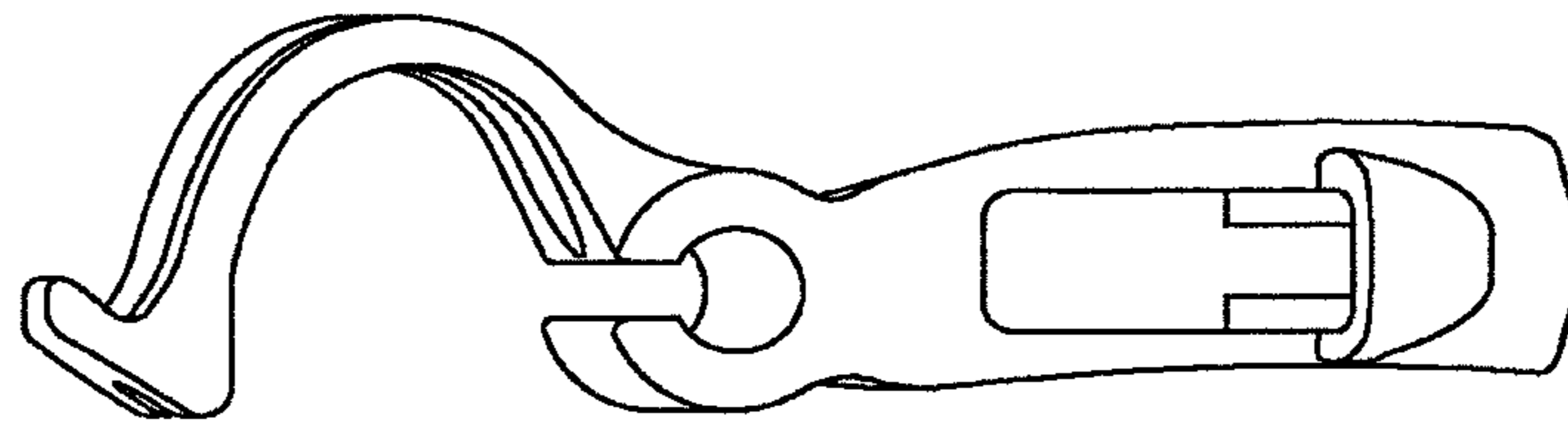

FIG.8

