



US00D724942S

(12) **United States Design Patent**  
**Mattila et al.**

(10) **Patent No.:** **US D724,942 S**  
(45) **Date of Patent:** **\*\* Mar. 24, 2015**

(54) **PACKAGING**

(71) Applicant: **Nokia Corporation**, Espoo (FI)

(72) Inventors: **Mika Mattila**, Tampere (FI); **Toni Sjöblon**, Kaarina (FI)

(73) Assignee: **Nokia Corporation**, Espoo (FI)

(\*\*) Term: **14 Years**

(21) Appl. No.: **29/483,440**

(22) Filed: **Feb. 28, 2014**

(51) **LOC (10) Cl.** ..... **09-03**

(52) **U.S. Cl.**

USPC ..... **D9/432**

(58) **Field of Classification Search**

CPC ..... B65D 5/00; B65D 5/0015; B65D 5/0045;  
B65D 5/18; B65D 5/40; B65D 5/2033;  
B65D 1/22; B65D 1/225; B65D 1/24; B65D  
1/34; B65D 1/38

USPC ..... D9/414-433, 444-445, 456, 519, 529,  
D9/560, 715, 718, 748; D7/601, 602, 538,  
D7/540, 550.1, 552.1, 554.3, 554.4;  
D3/203.5, 202, 207, 210

See application file for complete search history.

(56) **References Cited**

**U.S. PATENT DOCUMENTS**

D261,110 S *	10/1981	Yoshimoto	.....	D9/432
D342,205 S *	12/1993	Ritz	.....	D9/432
D477,999 S *	8/2003	Lloyd	.....	D9/414
D492,594 S *	7/2004	Nash	.....	D9/415
D553,494 S *	10/2007	Dehlin	.....	D9/432
D593,409 S *	6/2009	Blick	.....	D9/432

D668,540 S *	10/2012	Lutzig	.....	D9/432
D678,049 S *	3/2013	Bakker et al.	.....	D9/416
D704,545 S *	5/2014	Darmon	.....	D9/414
D713,716 S *	9/2014	Oja et al.	.....	D9/418
2006/0011498 A1 *	1/2006	Giannini et al.	.....	206/268
2008/0149507 A1 *	6/2008	Rose et al.	.....	206/267

\* cited by examiner

*Primary Examiner* — Susan Bennett Hattan

*Assistant Examiner* — Vy Koenig

(74) *Attorney, Agent, or Firm* — Banner & Witcoff, Ltd.

(57) **CLAIM**

The ornamental design for packaging, as shown and described.

**DESCRIPTION**

FIG. 1 is a perspective front view of packaging showing our new design in an unassembled state;  
FIG. 2 is a front view thereof;  
FIG. 3 is a rear view thereof;  
FIG. 4 is a right side view thereof;  
FIG. 5 is a left side view thereof;  
FIG. 6 is a top view thereof;  
FIG. 7 is a bottom view thereof;  
FIG. 8 is a perspective front view of the packaging of FIGS. 1-7 shown in an assembled state;  
FIG. 9 is a front view thereof;  
FIG. 10 is a rear view thereof;  
FIG. 11 is a right side view thereof;  
FIG. 12 is a left side view thereof;  
FIG. 13 is a top view thereof; and,  
FIG. 14 is a bottom view thereof.

The broken lines showing of various portions of the packaging in the figures are for environmental purposes only and form no part of the claimed design.

**1 Claim, 10 Drawing Sheets**

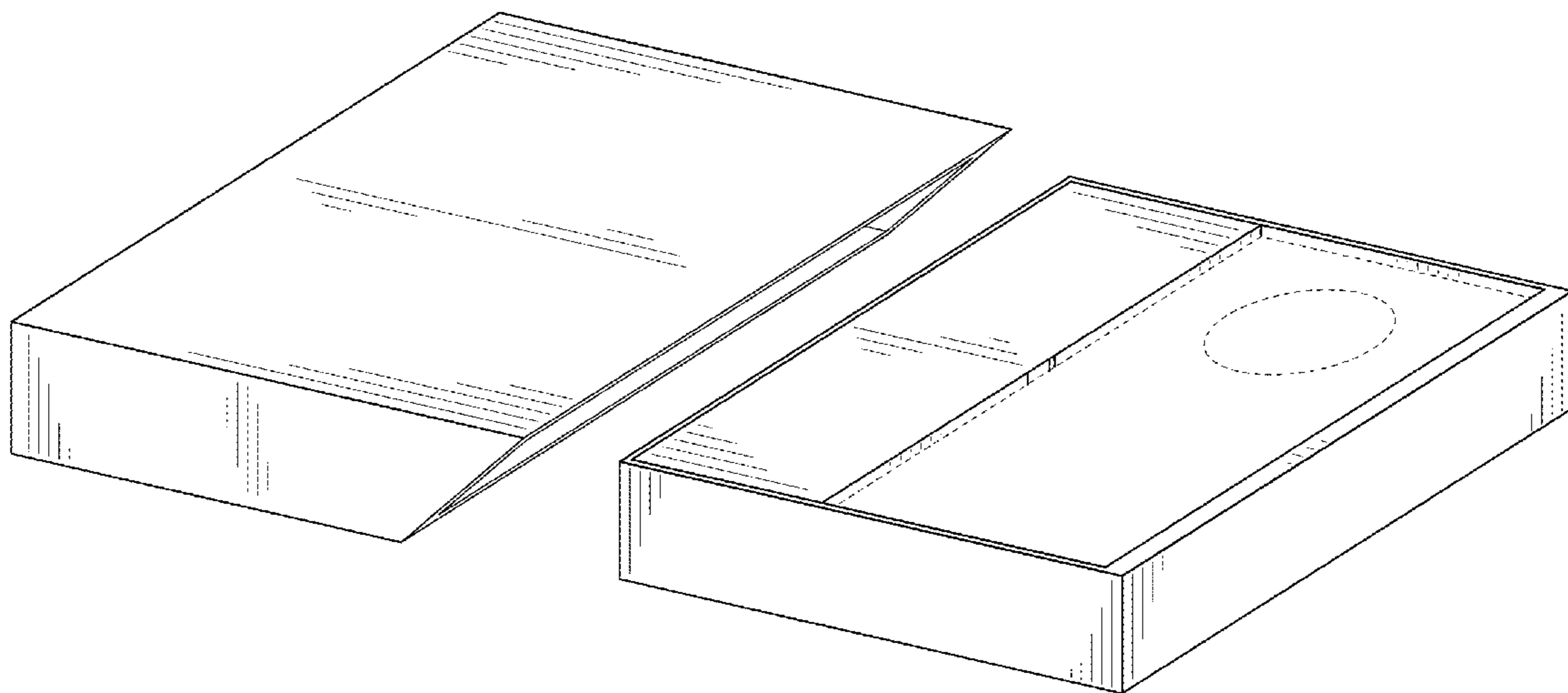

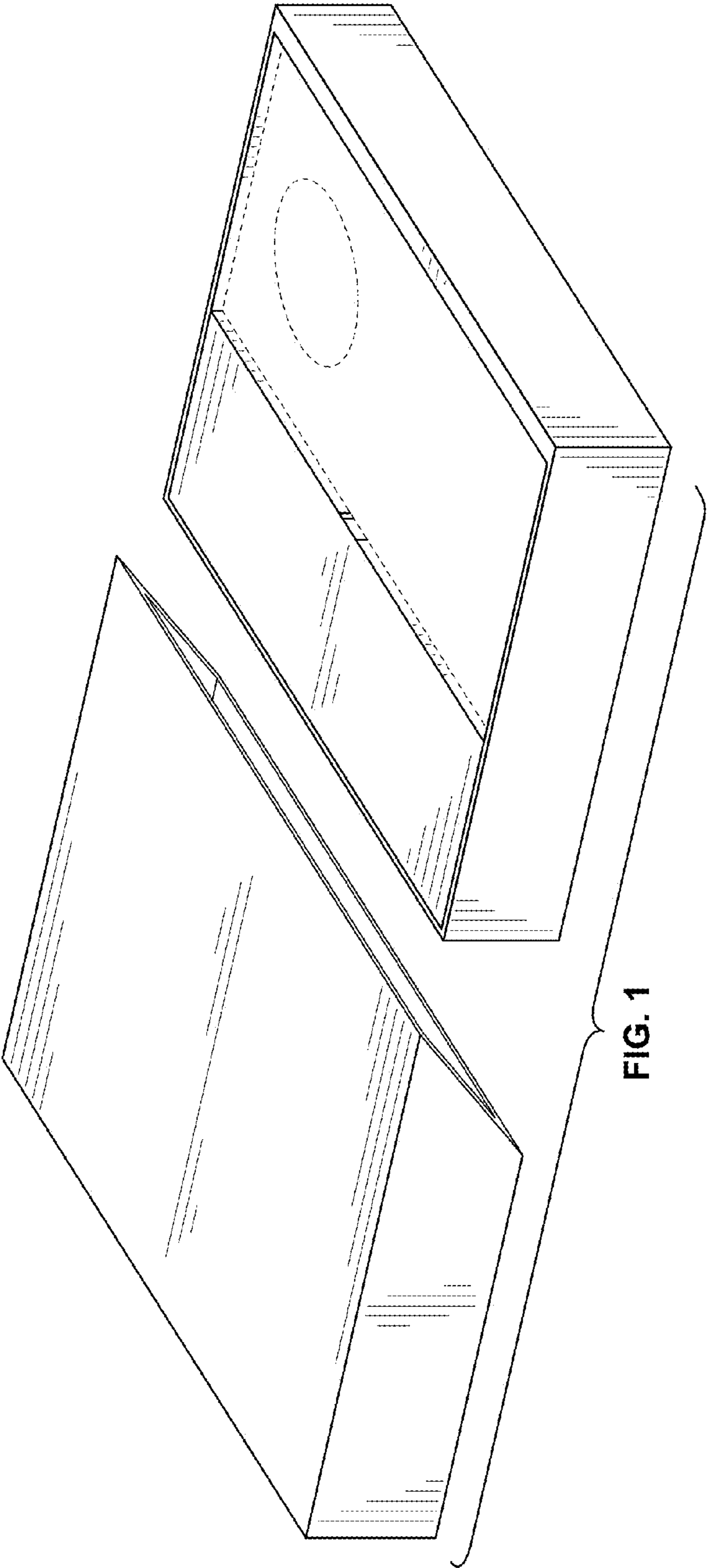

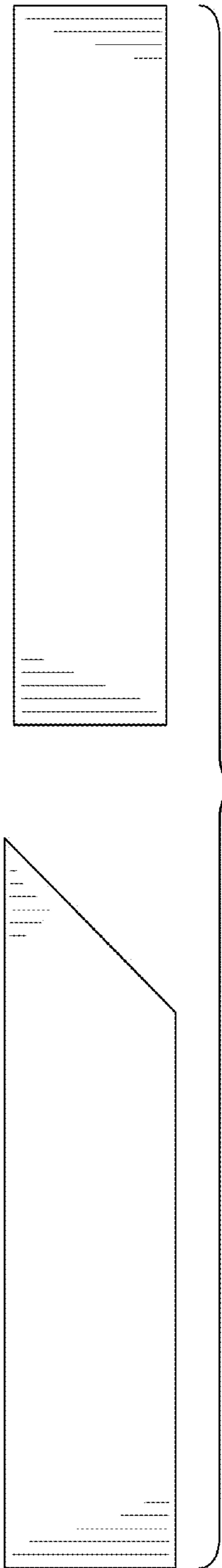

FIG. 2

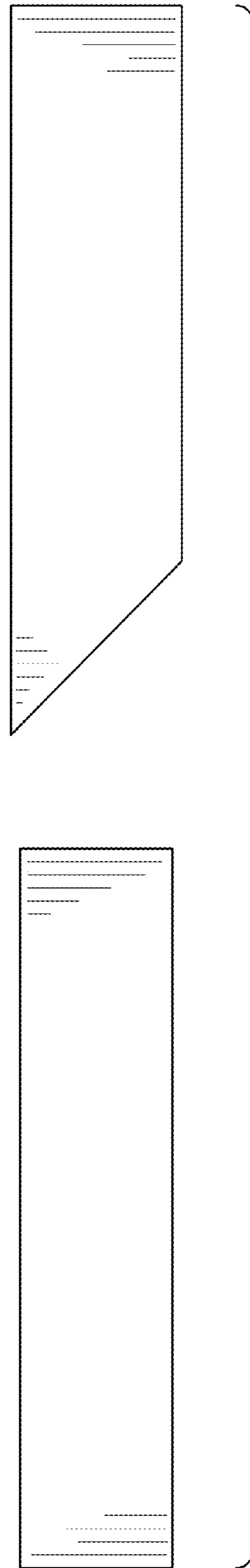

FIG. 3

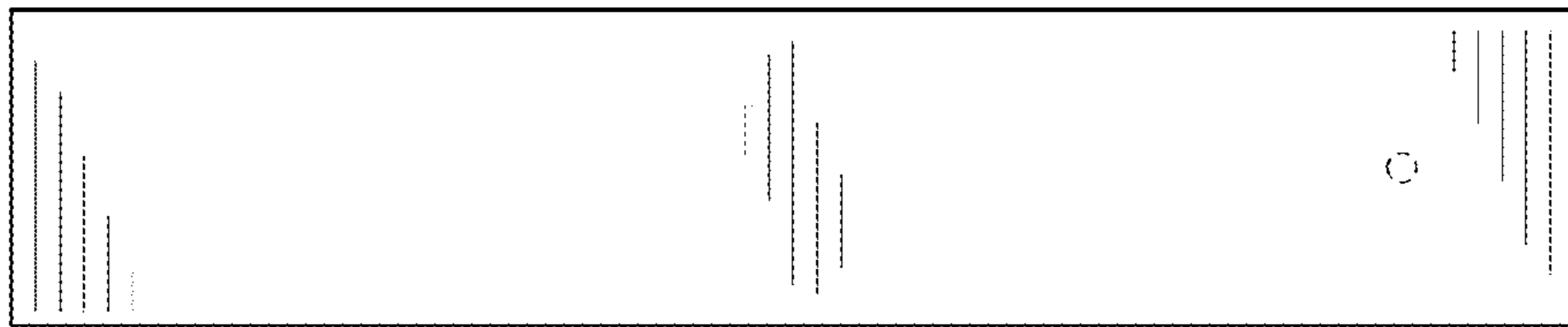

FIG. 5

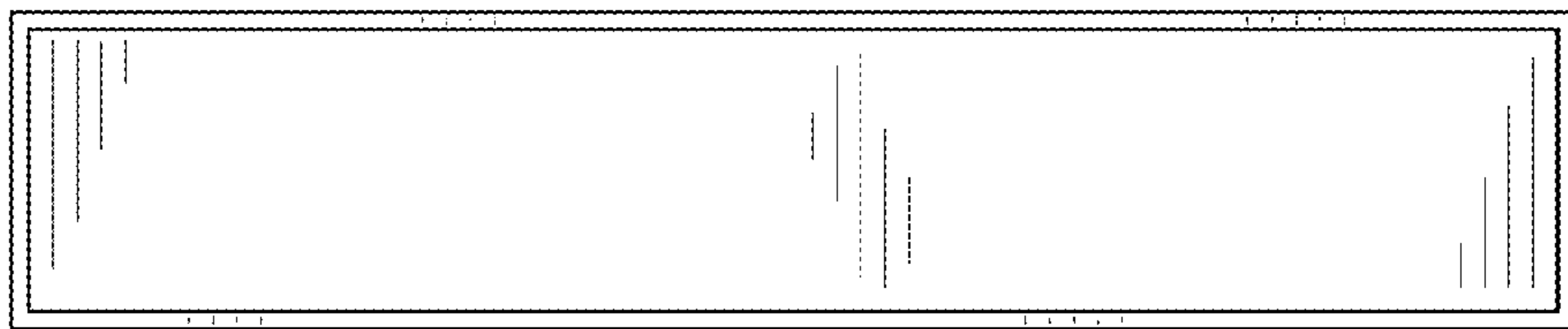

FIG. 4

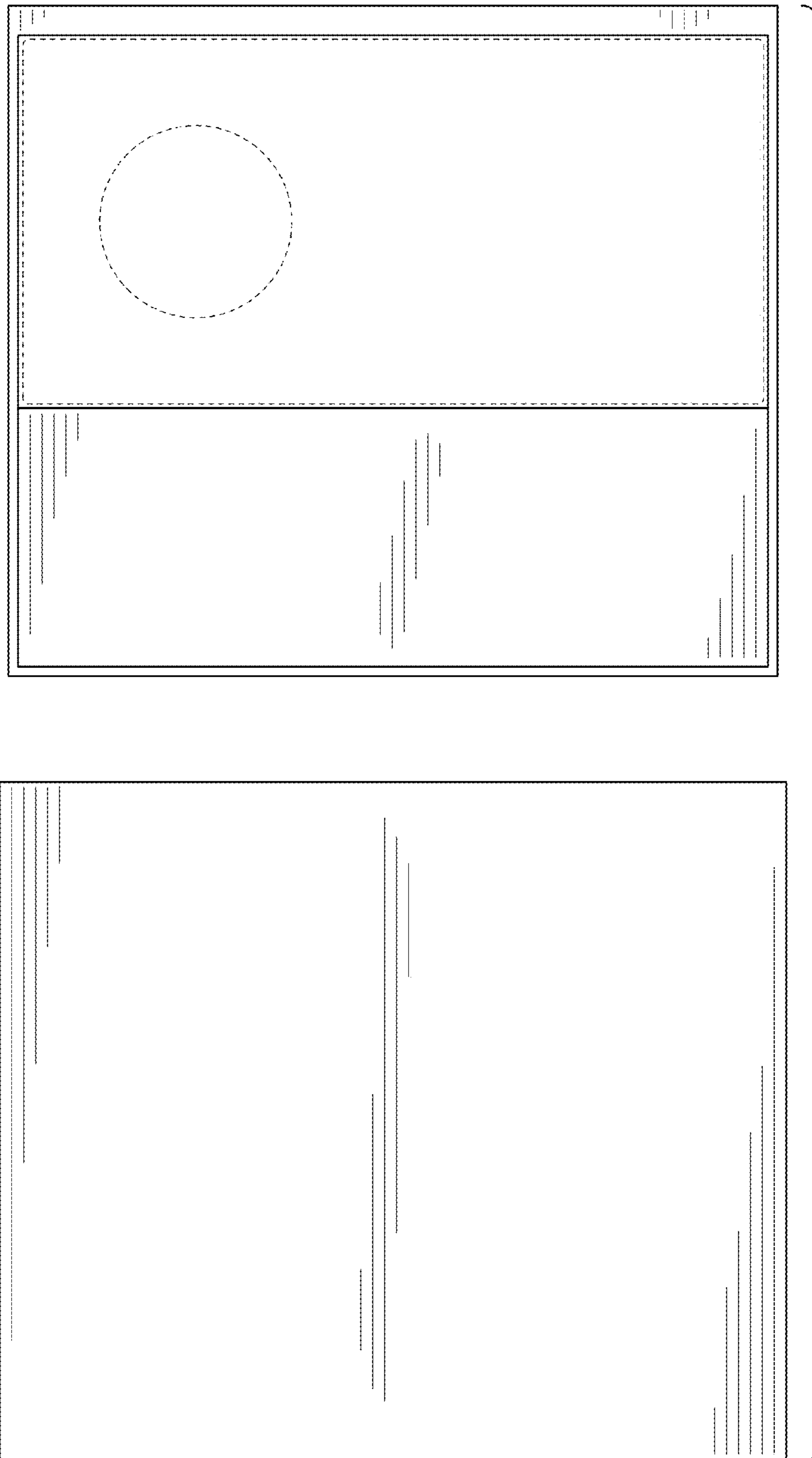

FIG. 6

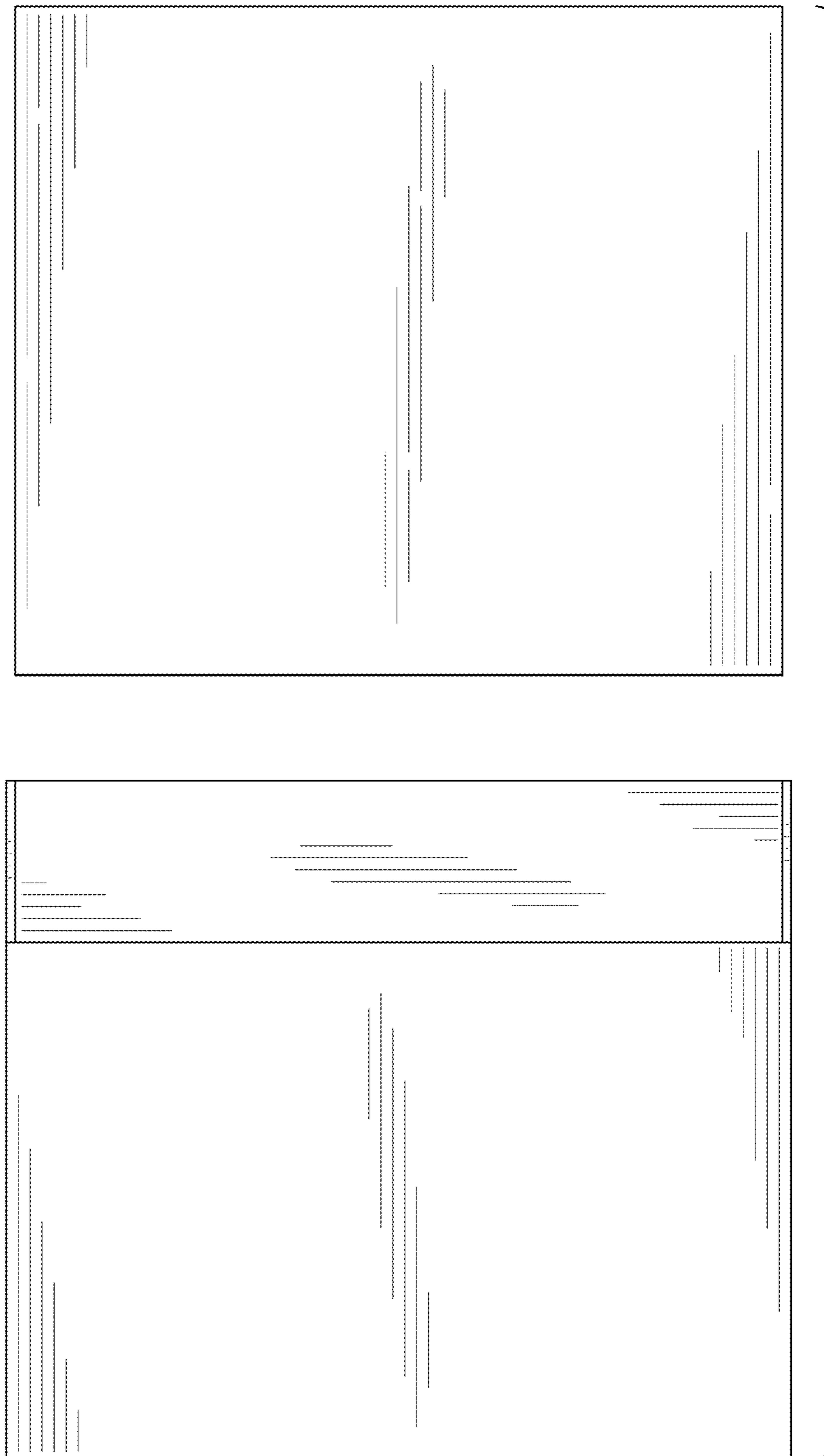

FIG. 7

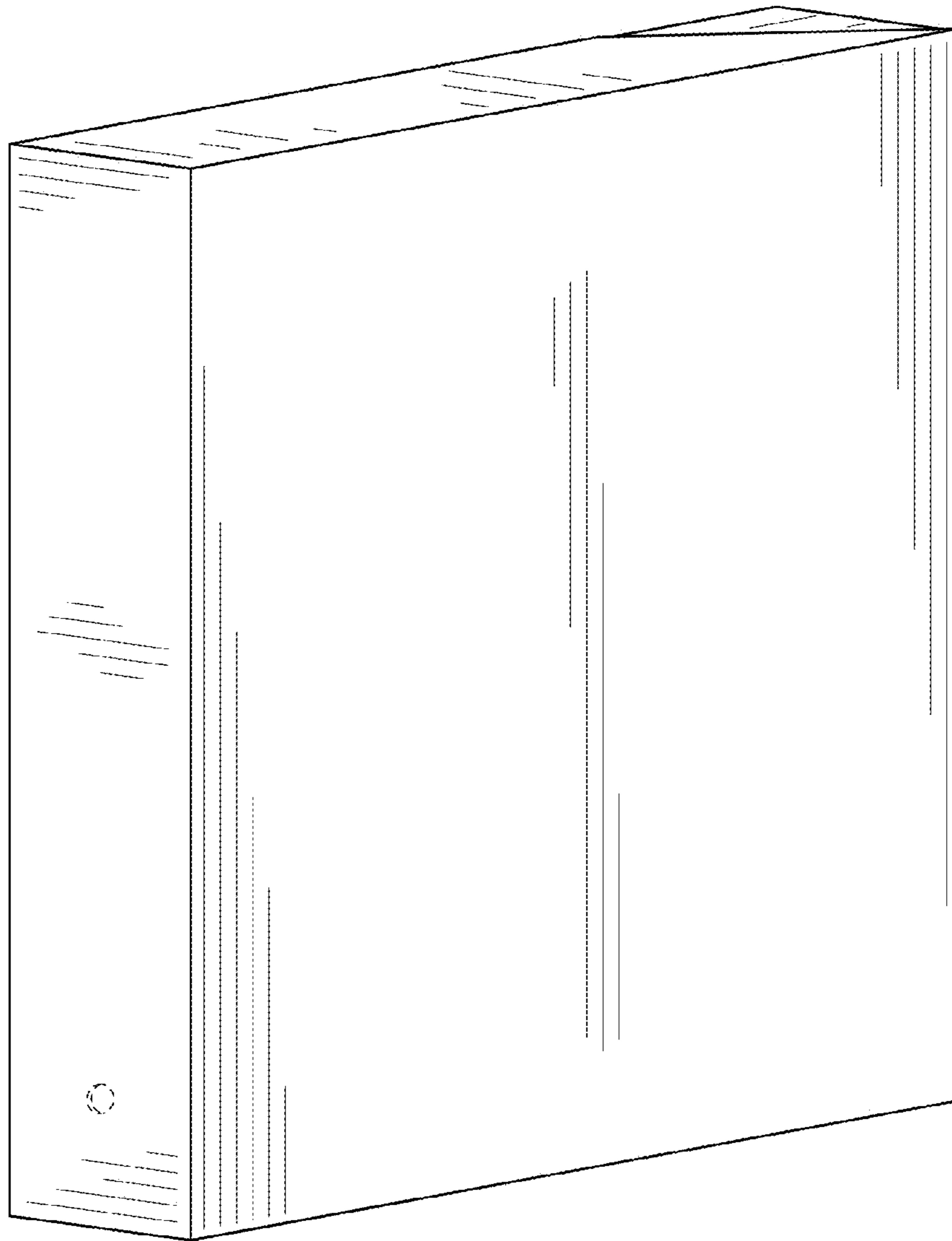

FIG. 8



FIG. 9

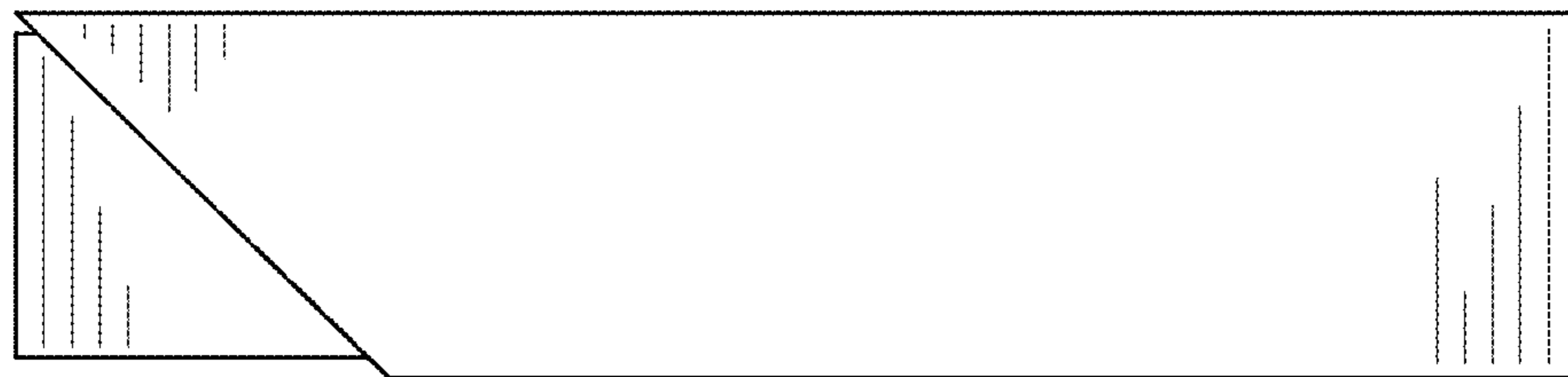

FIG. 10



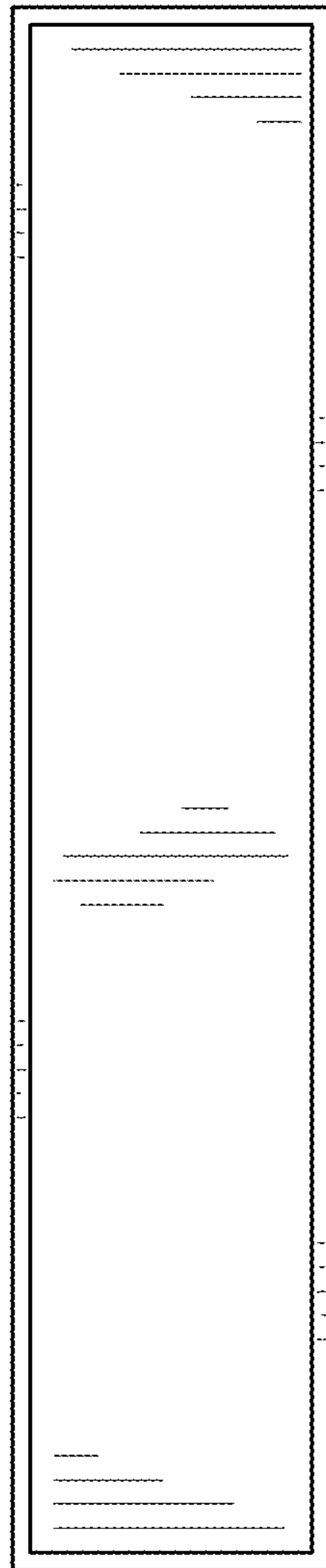

FIG. 11

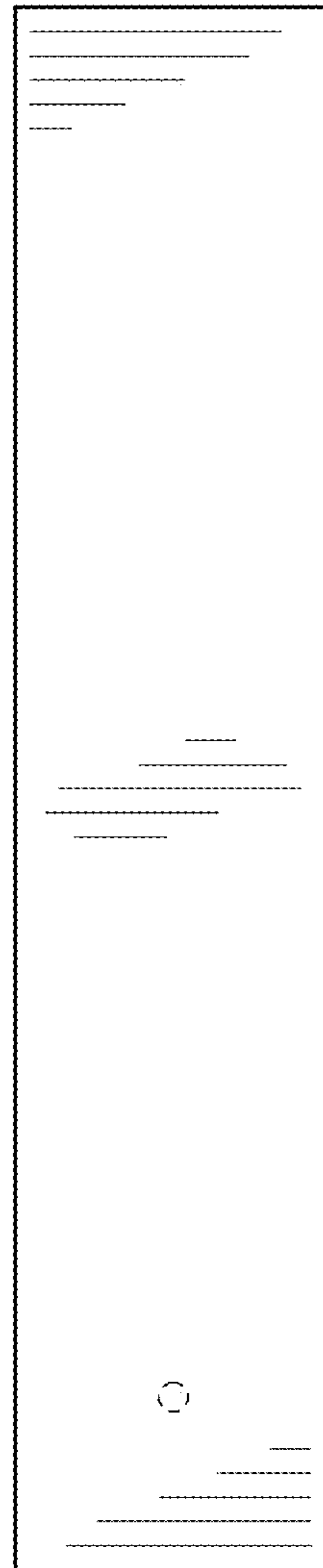

FIG. 12

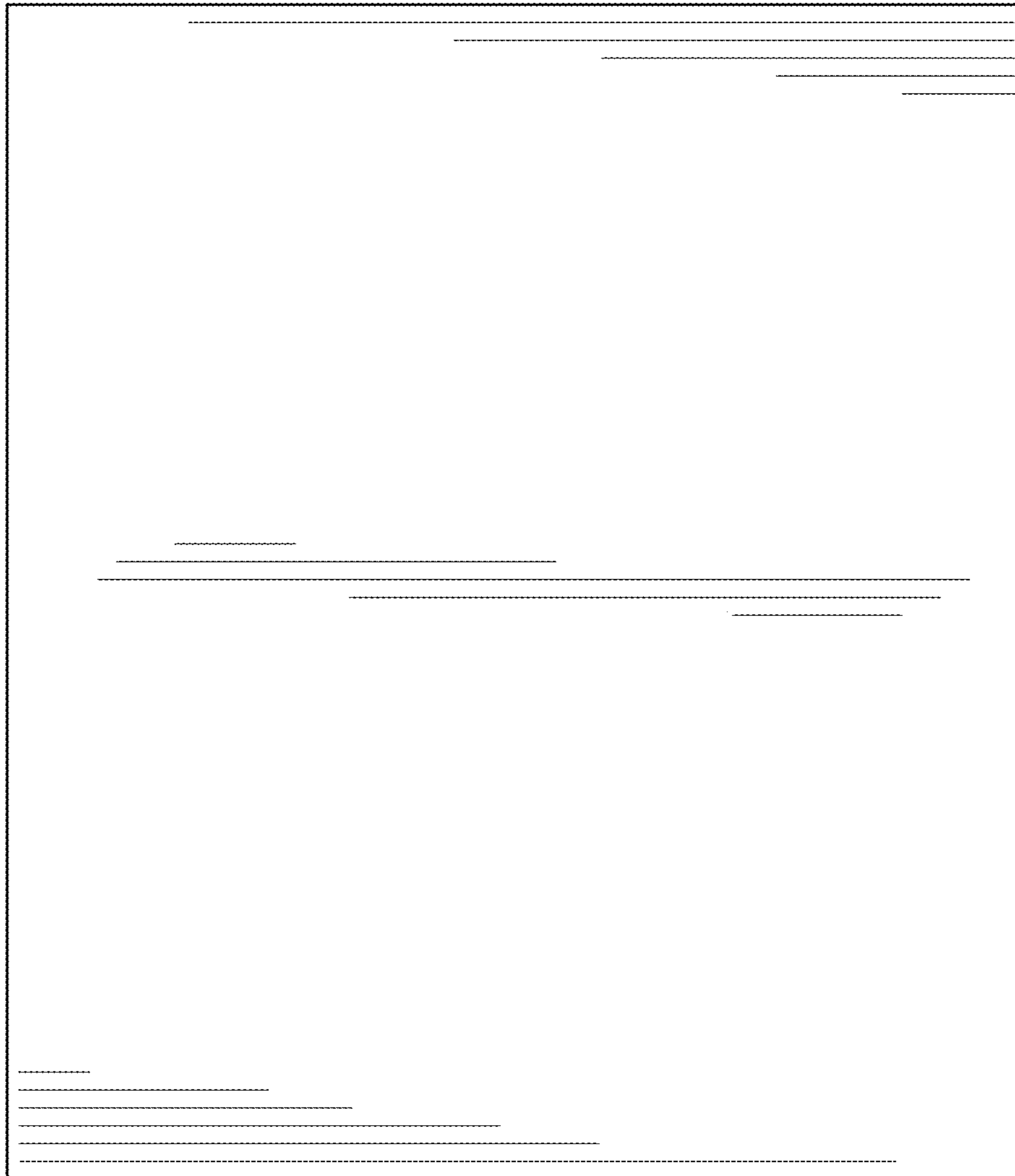

FIG. 13

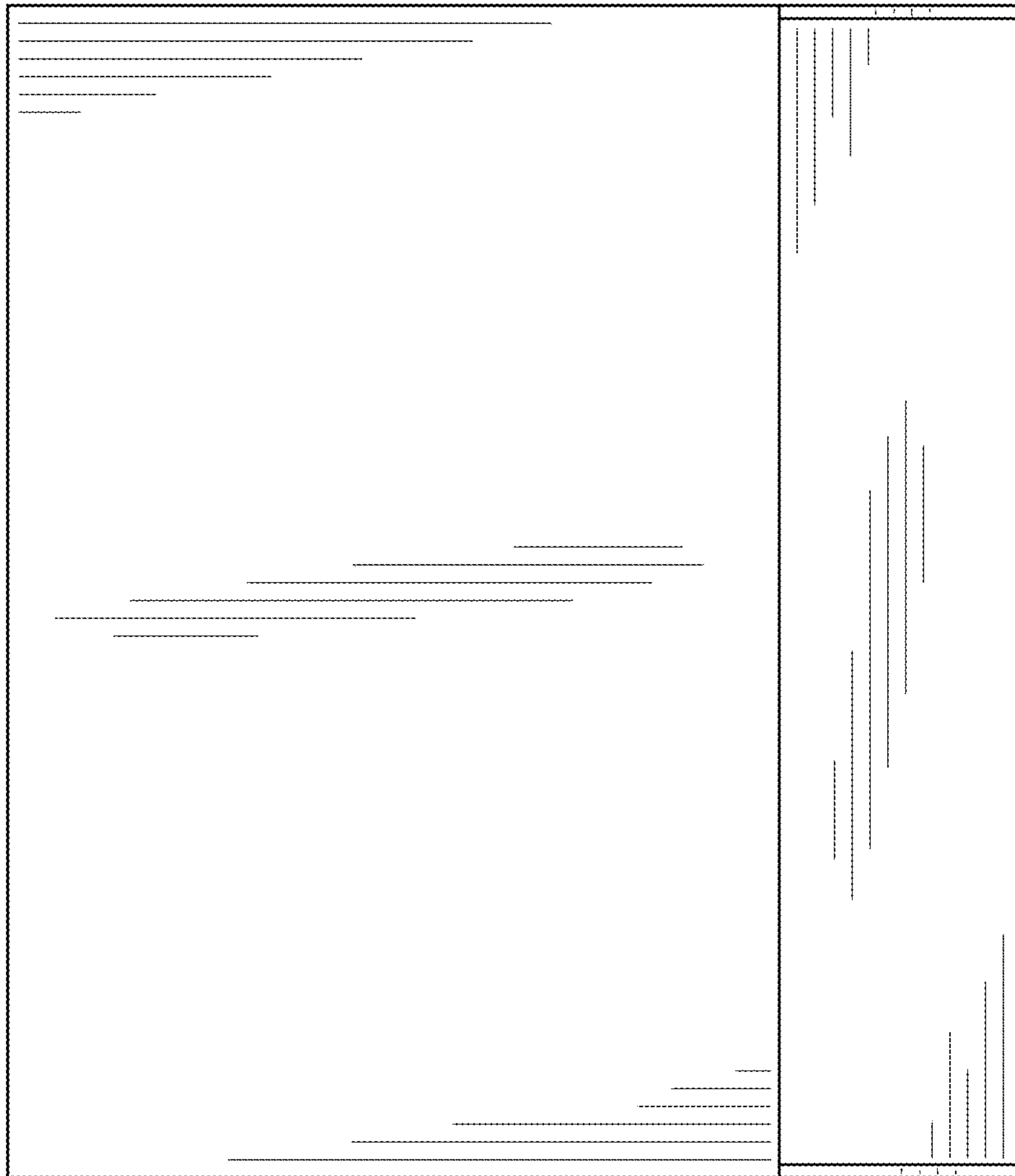

FIG. 14

UNITED STATES PATENT AND TRADEMARK OFFICE  
**CERTIFICATE OF CORRECTION**

PATENT NO. : D724,942 S  
APPLICATION NO. : 29/483440  
DATED : March 24, 2015  
INVENTOR(S) : Mika Mattila et al.

Page 1 of 1

It is certified that error appears in the above-identified patent and that said Letters Patent is hereby corrected as shown below:

On the Title Page

In the item (72) entitled "Inventors,":

"Toni Sjöblon" has been replaced with -- Toni Sjöblom --

Signed and Sealed this  
Third Day of October, 2017



Joseph Matal  
*Performing the Functions and Duties of the  
Under Secretary of Commerce for Intellectual Property and  
Director of the United States Patent and Trademark Office*