



US00D724939S

(12) **United States Design Patent**  
**Smagin et al.**

(10) **Patent No.:** **US D724,939 S**  
(45) **Date of Patent:** **\*\* Mar. 24, 2015**

(54) **TRIMMER LINE WINDING PACKAGE**

(71) Applicant: **Andreas Stihl AG & Co. KG**,  
Waiblingen (DE)

(72) Inventors: **Vladimir Smagin**, Virginia Beach, VA  
(US); **Robert Jamieson Pearson**,  
Norfolk, VA (US); **Andreas**  
**Garstenaue**r, Chesapeake, VA (US);  
**Thorsten Schilling**, Virginia Beach, VA  
(US)

(73) Assignee: **Andreas Stihl AG & Co. KG**,  
Waiblingen (DE)

(\*\*) Term: **14 Years**

(21) Appl. No.: **29/461,070**

(22) Filed: **Jul. 18, 2013**

(30) **Foreign Application Priority Data**

Feb. 15, 2013 (EM) ..... 002185173-0001

(51) **LOC (10) Cl.** ..... **09-03**

(52) **U.S. Cl.**  
USPC ..... **D9/419**

(58) **Field of Classification Search**  
USPC ..... D9/419, 415, 418, 424, 429, 457, 456,  
D9/455, 452, 499, 722; 206/461, 463, 465,  
206/776, 779, 769, 735, 349, 320, 470,  
206/403; 53/430

See application file for complete search history.

(56) **References Cited**

**U.S. PATENT DOCUMENTS**

D277,731 S \* 2/1985 Sharp et al. .... D9/722  
D341,777 S \* 11/1993 Sheu ..... D9/415  
6,029,815 A \* 2/2000 Ali ..... 206/349

6,109,005 A \* 8/2000 Fogle ..... 53/430  
6,170,663 B1 \* 1/2001 Glassman ..... 206/461  
6,868,966 B2 \* 3/2005 German, III ..... 206/349  
D524,643 S 7/2006 Legrand  
D561,579 S \* 2/2008 Aronson et al. .... D9/415  
7,513,369 B1 \* 4/2009 Lee ..... 206/779  
D605,033 S \* 12/2009 Iacona ..... D9/415  
8,069,983 B2 \* 12/2011 Cross ..... 206/349  
8,230,995 B2 \* 7/2012 Andrews et al. .... 206/403  
8,622,211 B2 \* 1/2014 Zorc ..... 206/349  
2004/0149604 A1 \* 8/2004 Humphrey ..... 206/320  
2005/0194281 A1 \* 9/2005 Richards et al. .... 206/470

\* cited by examiner

*Primary Examiner* — Ian Simmons

*Assistant Examiner* — Rhea Shields

(74) *Attorney, Agent, or Firm* — McGuireWoods LLP

(57) **CLAIM**

We claim the ornamental design for a trimmer line winding package, as shown and described.

**DESCRIPTION**

FIG. 1 is a right perspective view of the trimmer line winding package;

FIG. 2 is a front view of the trimmer line winding package shown in FIG. 1;

FIG. 3 is a rear view of the trimmer line winding package shown in FIG. 1;

FIG. 4 is a left side profile view of the trimmer line winding package shown in FIG. 1;

FIG. 5 is a right side profile view of the trimmer line winding package shown in FIG. 1;

FIG. 6 is a top view of the trimmer line winding package shown in FIG. 1; and,

FIG. 7 is a bottom view of the trimmer line winding package shown in FIG. 1.

In the drawings, the broken lines depict unclaimed subject matter only and form no part of the claimed design.

**1 Claim, 7 Drawing Sheets**

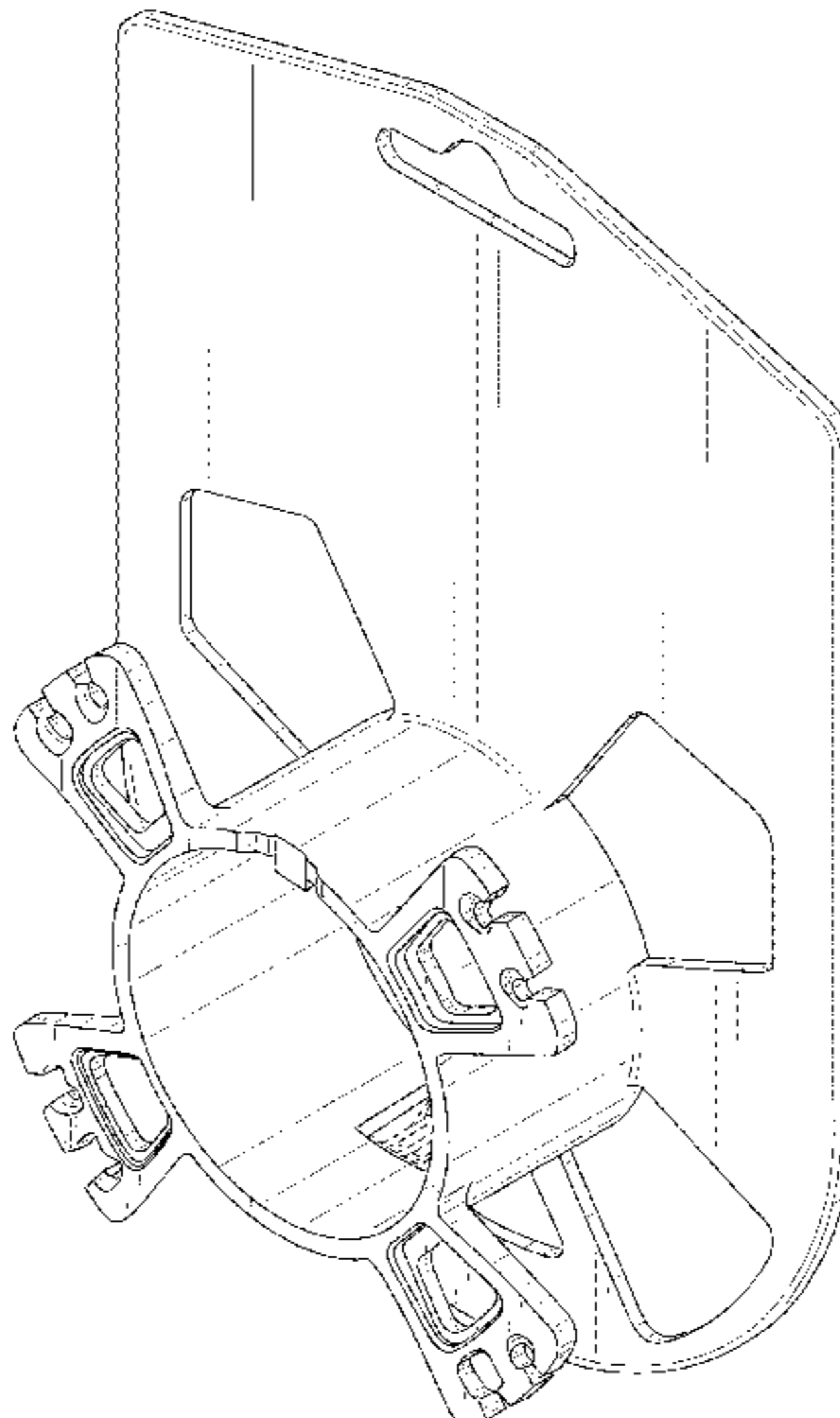

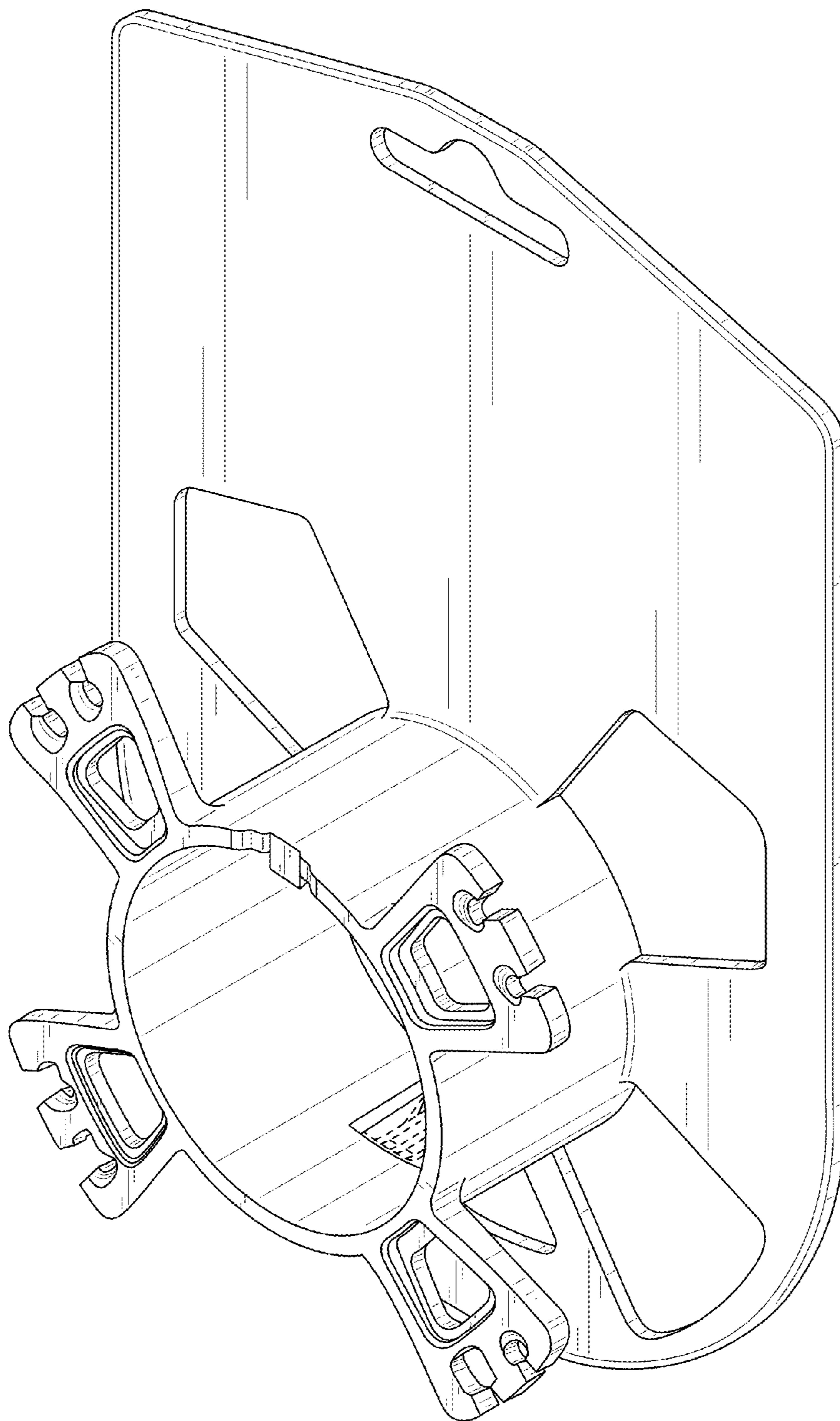

FIG. 1

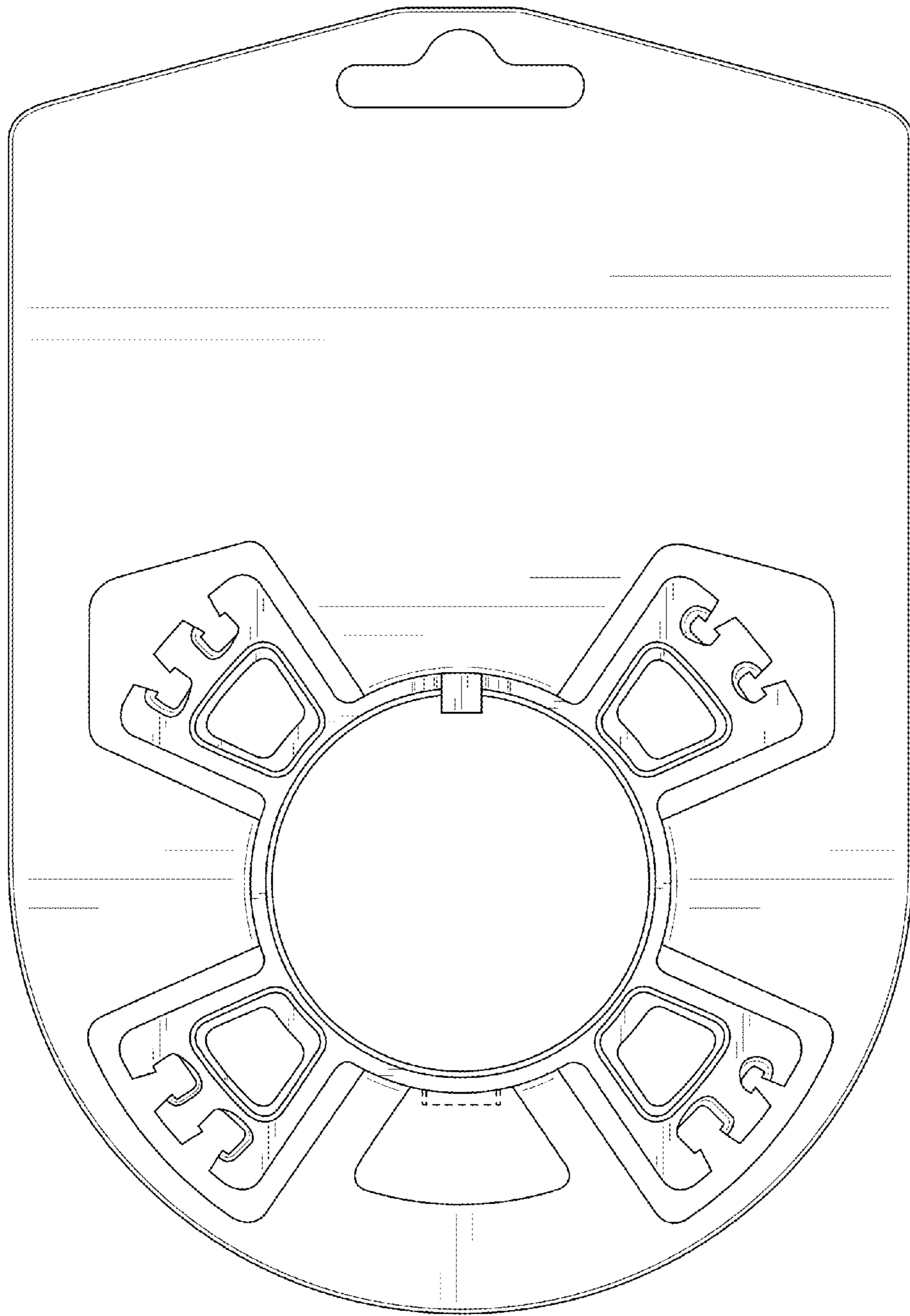

FIG. 2

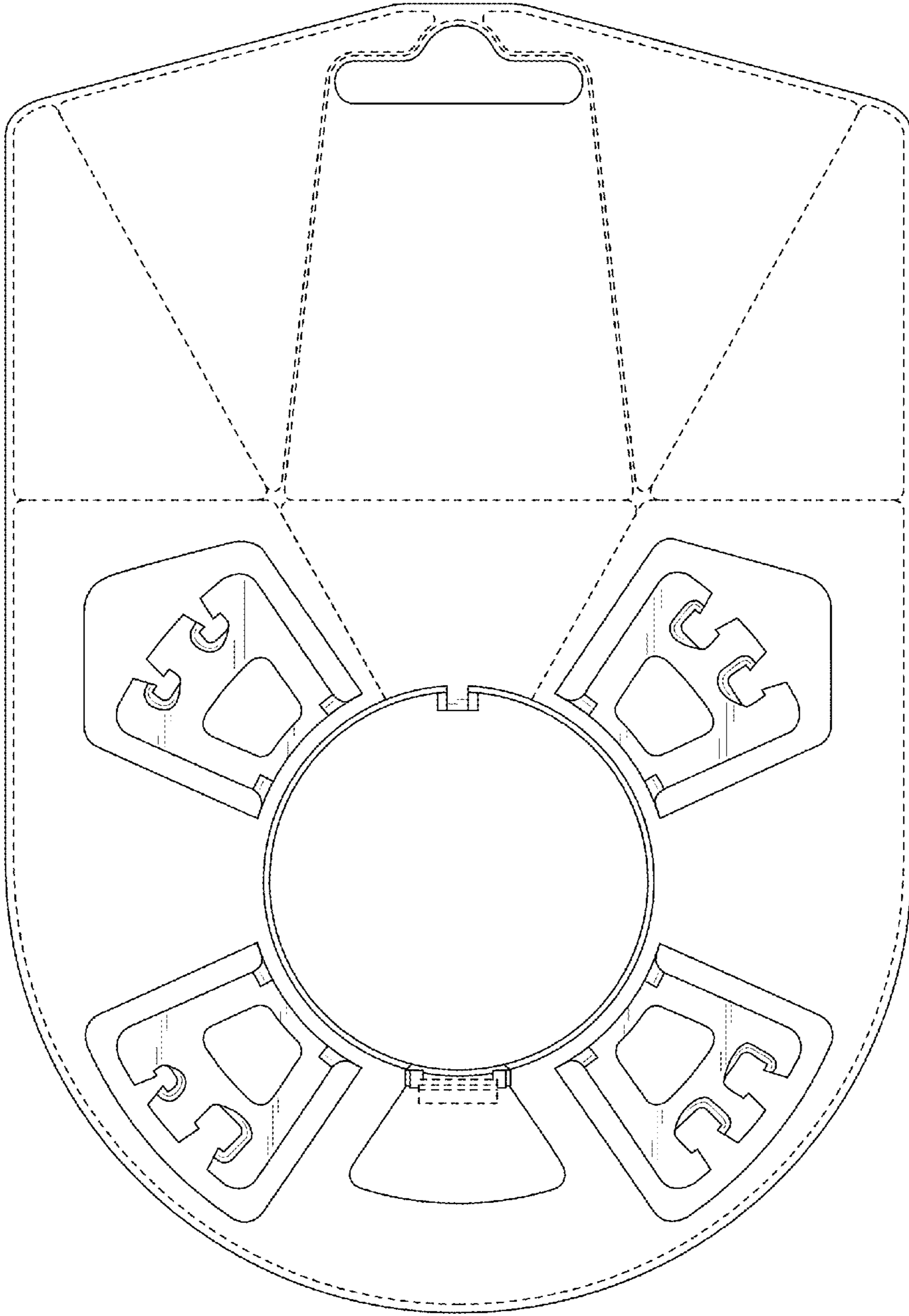

FIG. 3



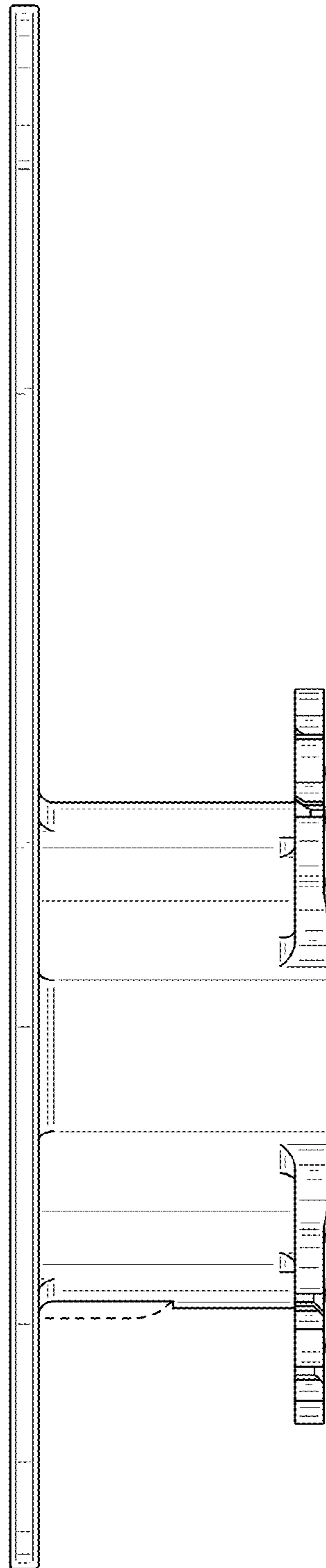

FIG. 4

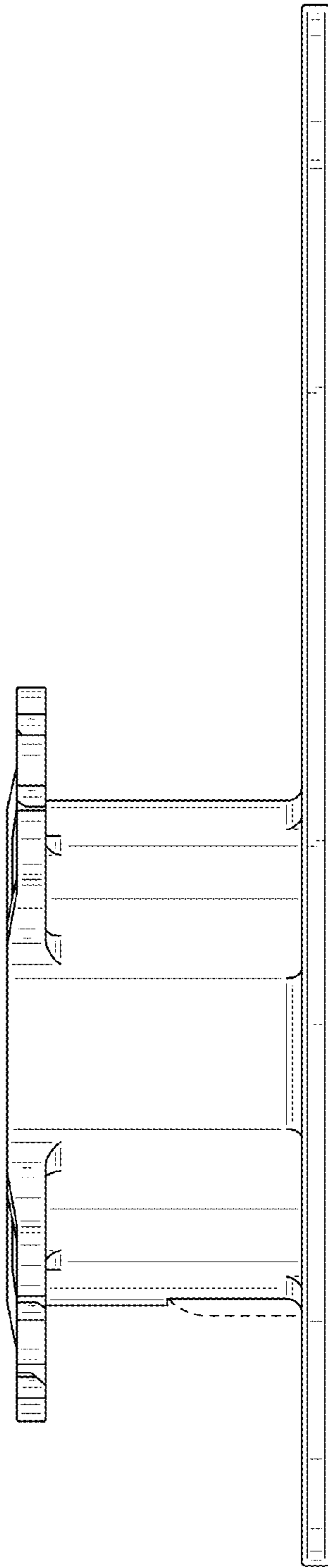

FIG. 5

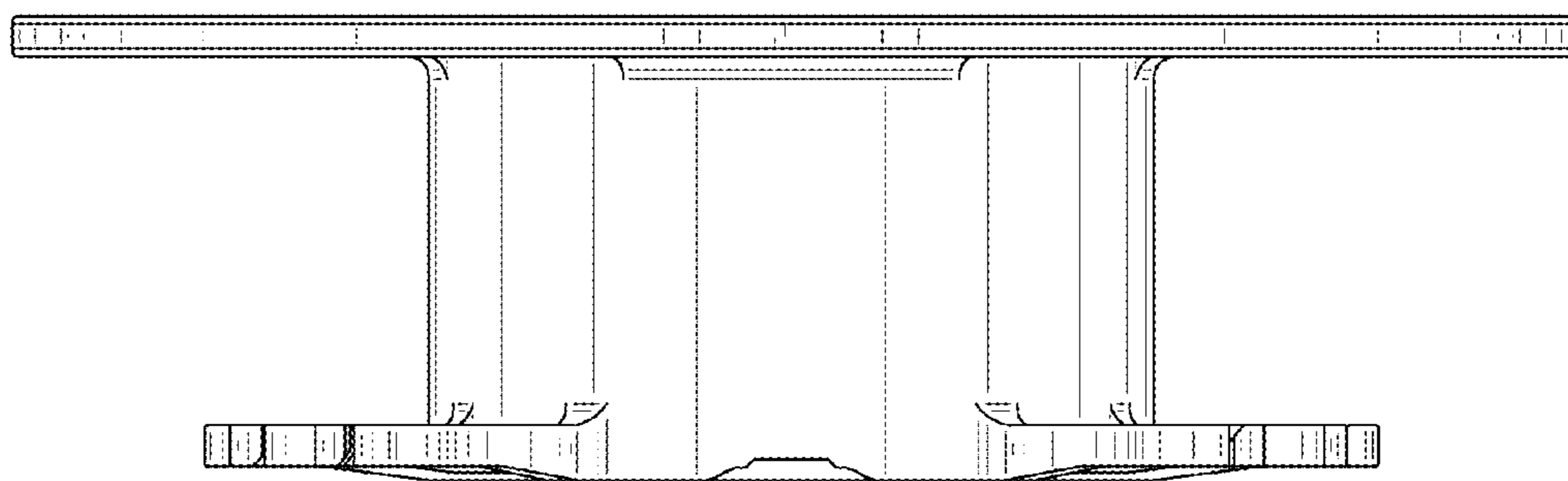

FIG. 6

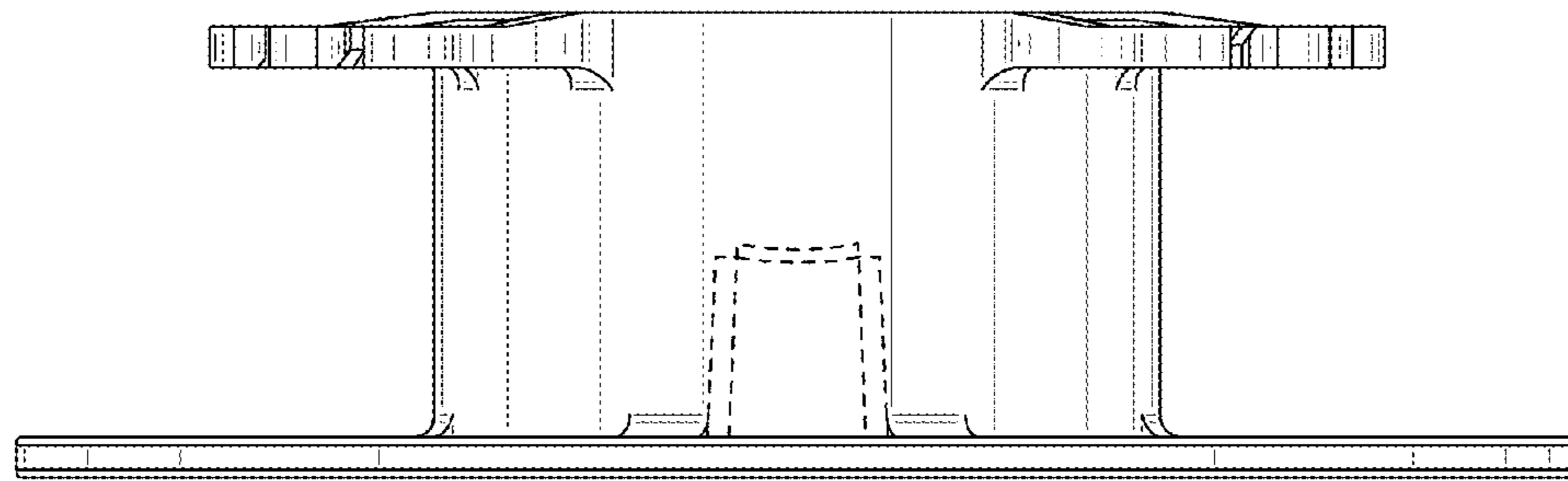

FIG. 7