



US00D724884S

(12) **United States Design Patent**
Struzka

(10) **Patent No.:** **US D724,884 S**
(45) **Date of Patent:** **** Mar. 24, 2015**

(54) **BEVERAGE DISPENSER**

(56) **References Cited**

(71) Applicant: **Societe des Produits Nestle S.A., Vevey**
(CH)

U.S. PATENT DOCUMENTS

(72) Inventor: **Pierre Struzka, La Chaux-de-Fonds**
(CH)

D400,754 S *	11/1998	Alferink	D7/309
D499,599 S *	12/2004	Morrison	D7/309
D563,712 S *	3/2008	Alferink	D7/306
D583,610 S *	12/2008	Lam	D7/309
D623,463 S *	9/2010	Struzka et al.	D7/309
D672,188 S *	12/2012	Luippold et al.	D7/306
8,360,279 B1 *	1/2013	Giles	222/145.6
D718,971 S *	12/2014	Young et al.	D7/306

(73) Assignee: **Societe des Produits Nestle S.A., Vevey**
(CH)

* cited by examiner

(**) Term: **14 Years**

Primary Examiner — Marianne Pandozzi

(21) Appl. No.: **29/490,981**

(74) *Attorney, Agent, or Firm* — K&L Gates LLP

(22) Filed: **May 15, 2014**

(57) **CLAIM**

The ornamental design for a beverage dispenser, as shown and described.

(30) **Foreign Application Priority Data**

DESCRIPTION

Dec. 24, 2013 (CH) 140335

FIG. 1 illustrates a front perspective view of a beverage dispenser according to the present disclosure;

(51) **LOC (10) Cl.** **07-01**

FIG. 2 illustrates a front side elevational view thereof;

(52) **U.S. Cl.**

FIG. 3 illustrates a back side elevational view thereof;

USPC **D7/306; D7/311**

FIG. 4 illustrates a left side elevational view thereof;

(58) **Field of Classification Search**

FIG. 5 illustrates a right side elevational view thereof;

CPC **A47J 31/00**

FIG. 6 illustrates a top plan view thereof; and,

USPC **D7/306-311, 300, 305, 301, 313;**

FIG. 7 illustrates a bottom plan view thereof.

99/282, 279, 280, 300, 305; 222/146.5,

The ornamental design that is claimed is shown in solid lines in the drawings. Any broken lines in the drawings are for illustrative purposes only and form no part of the claimed design.

222/129.1

See application file for complete search history.

1 Claim, 7 Drawing Sheets

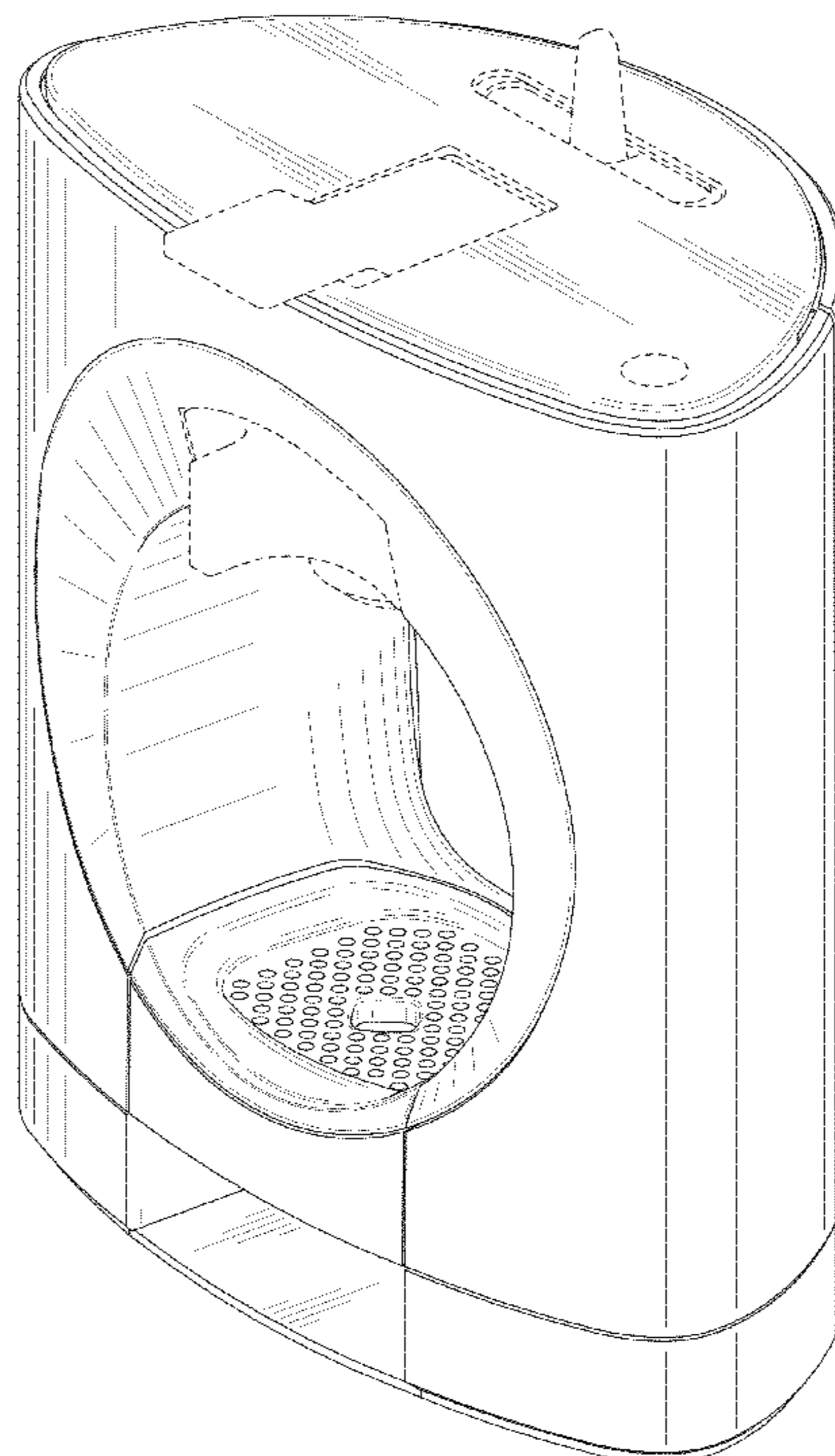

FIG. 1

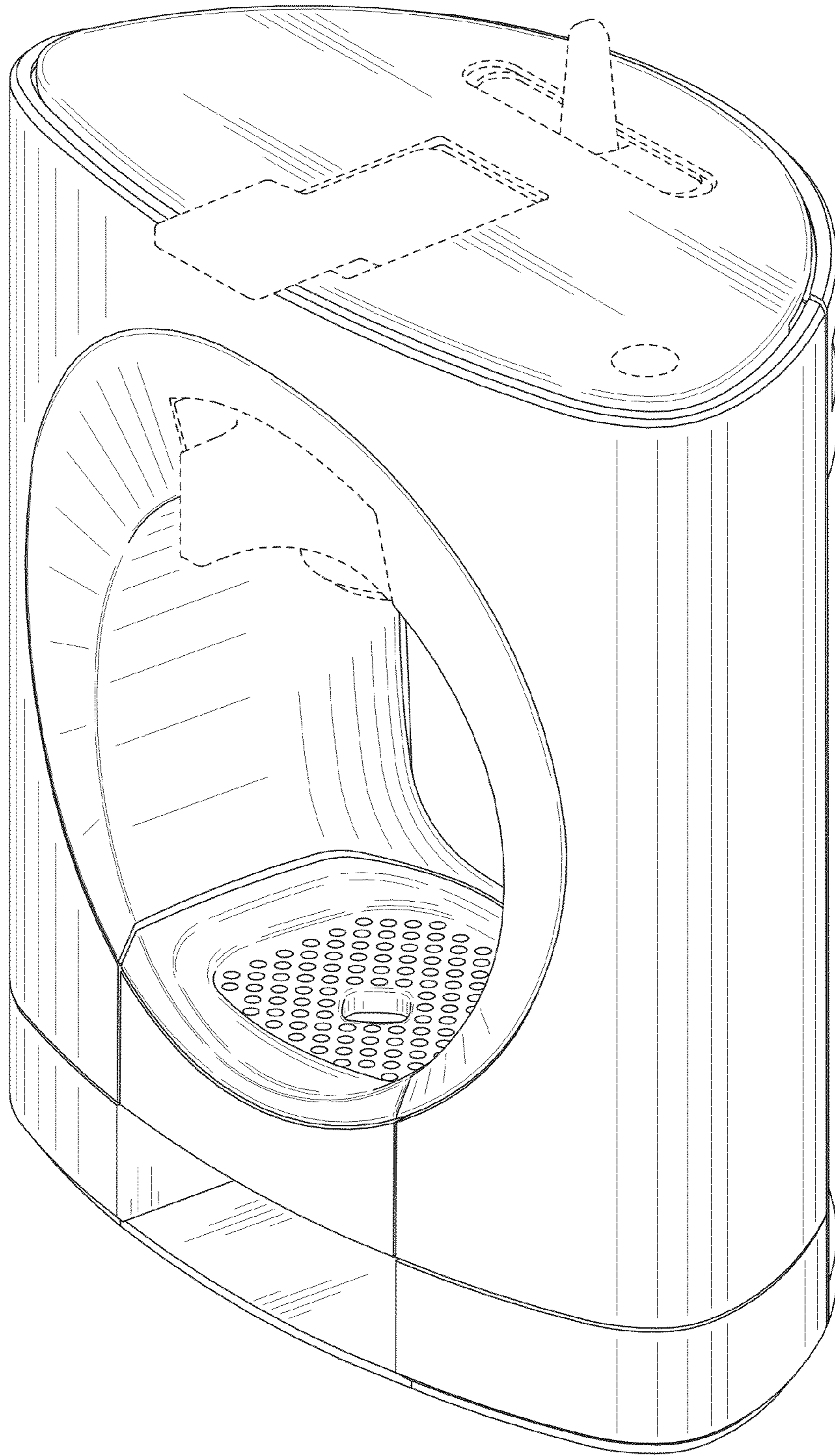

FIG. 2

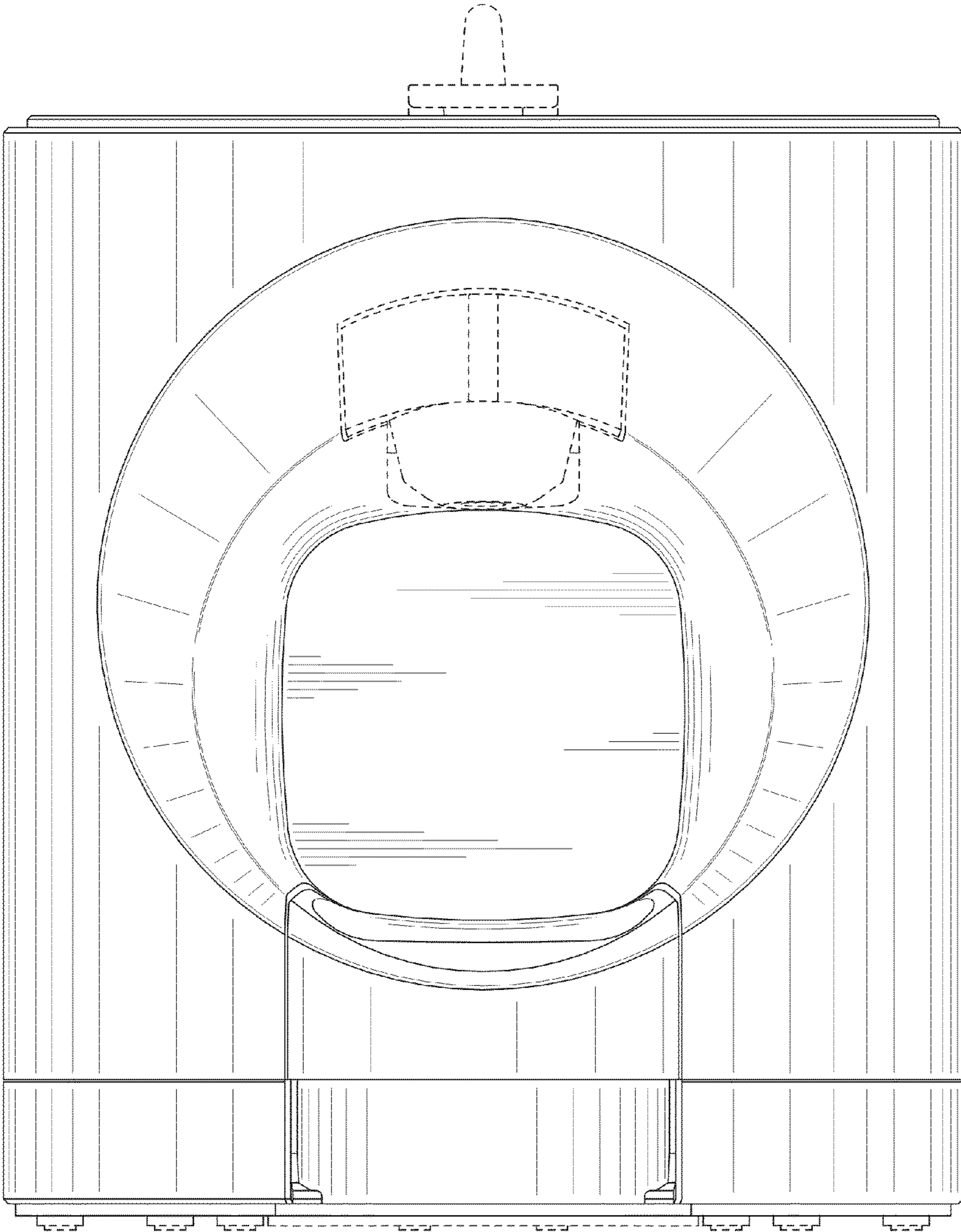

FIG. 3

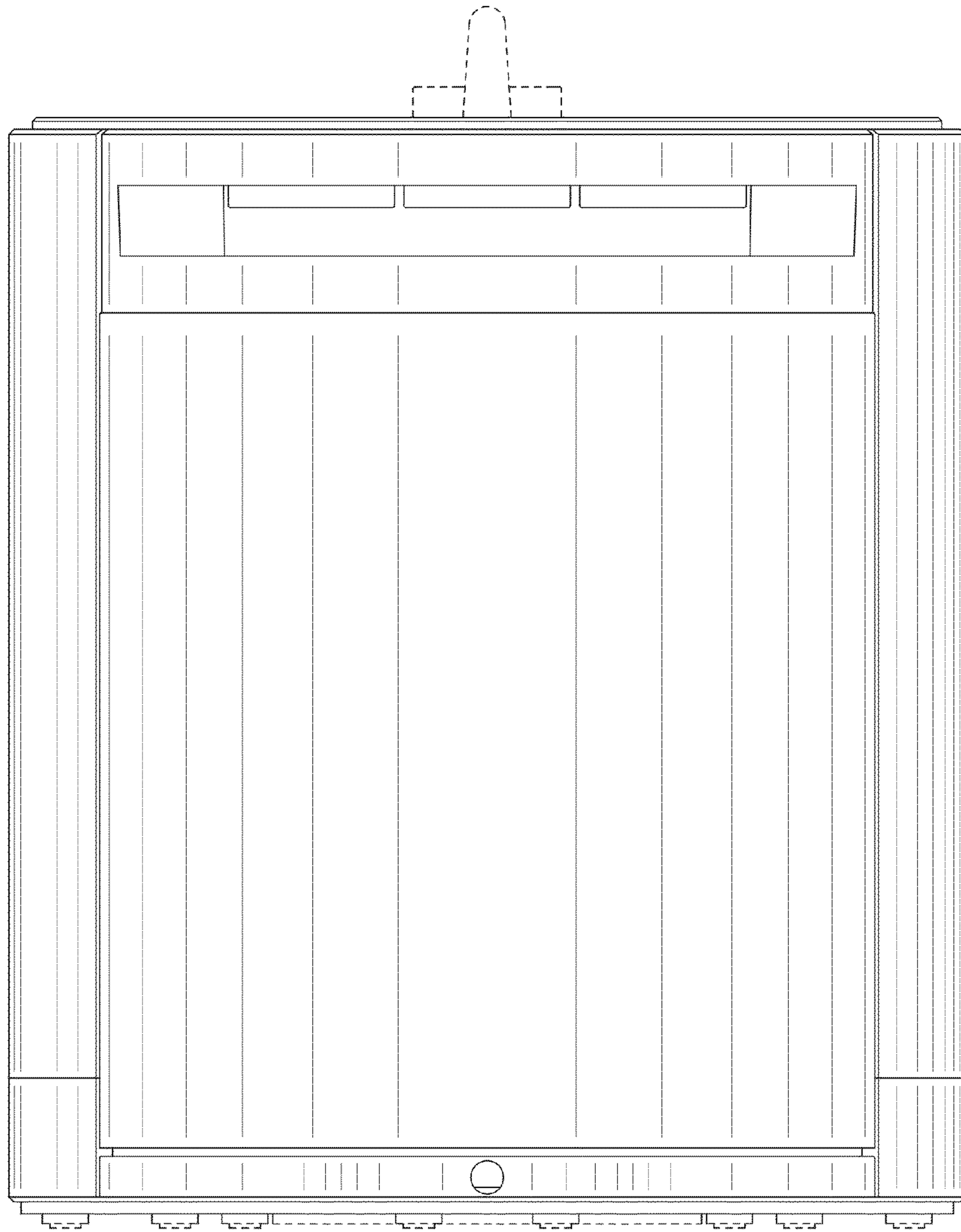

FIG. 4

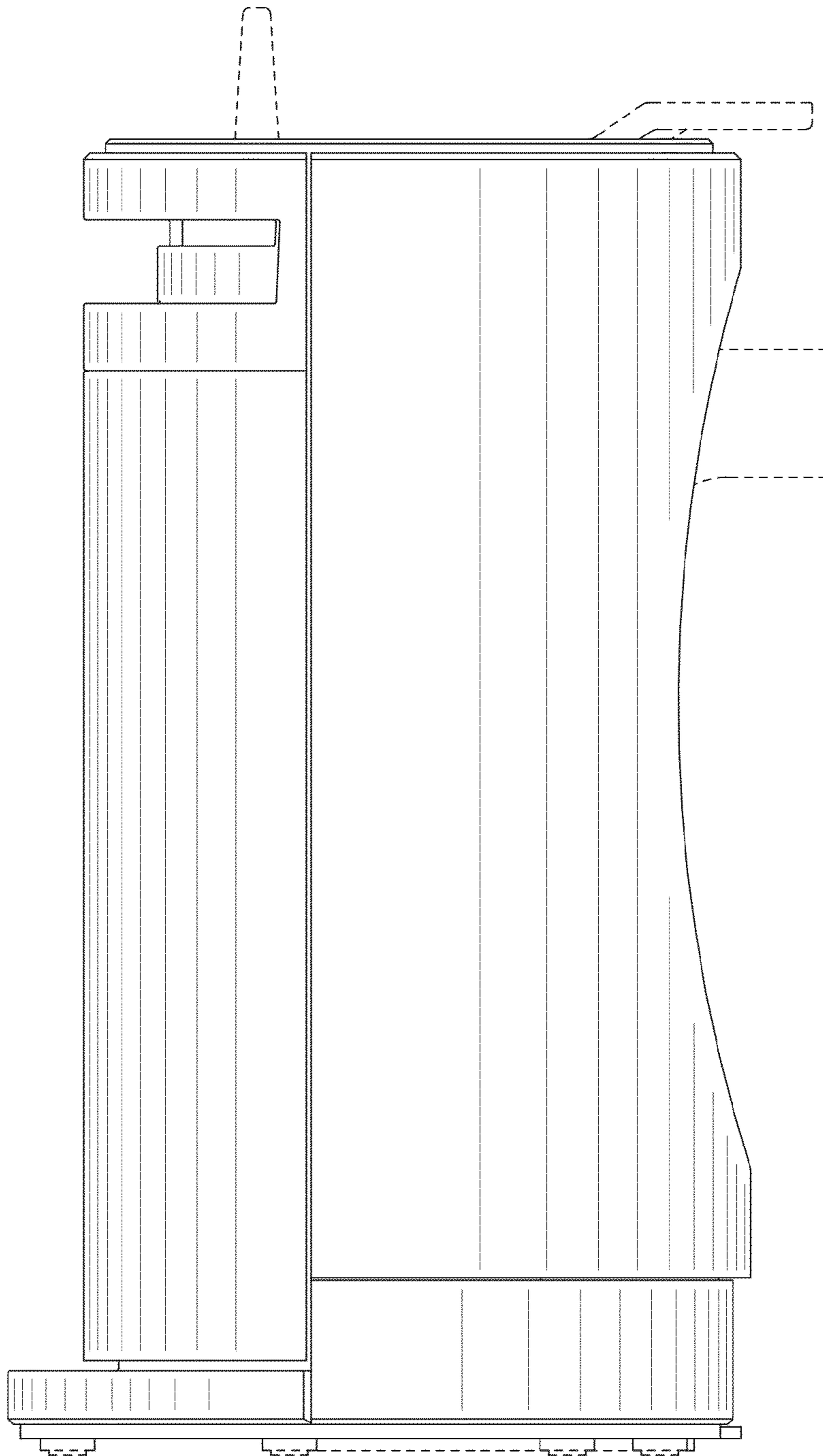

FIG. 5

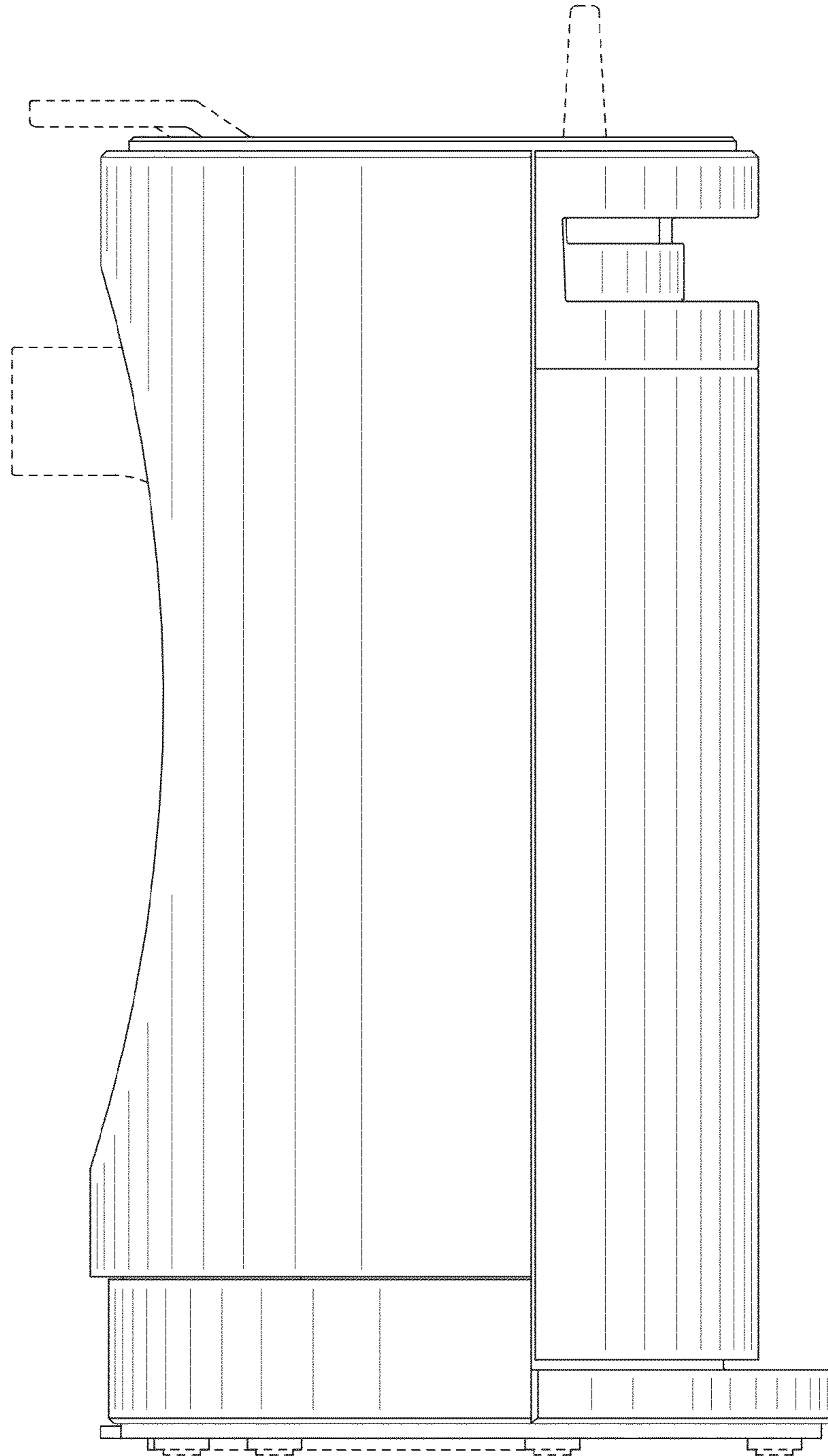

FIG. 6

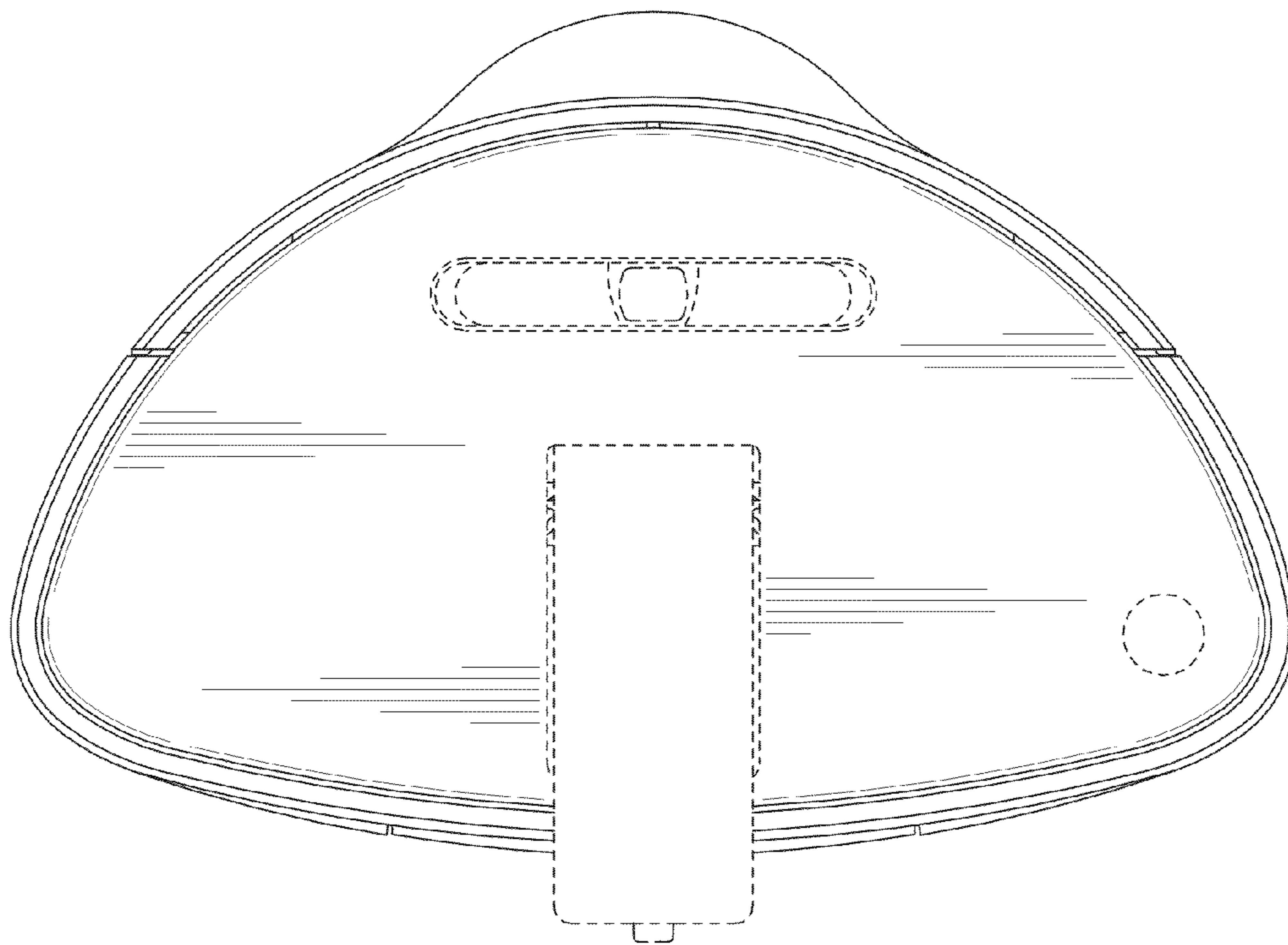

FIG. 7

