



US00D724792S

(12) **United States Design Patent**
Renforth et al.

(10) **Patent No.:** **US D724,792 S**

(45) **Date of Patent:** **** Mar. 17, 2015**

(54) **PET CARRIER**

(71) Applicants: **Jack William Renforth**, Arlington, TX (US); **Ann Hanson**, Ionia, MI (US); **Paul Fair**, Denver, CO (US); **Jaime Kummerfeld**, Greeley, CO (US); **Roy Swanson**, Littleton, CO (US)

(72) Inventors: **Jack William Renforth**, Arlington, TX (US); **Ann Hanson**, Ionia, MI (US); **Paul Fair**, Denver, CO (US); **Jaime Kummerfeld**, Greeley, CO (US); **Roy Swanson**, Littleton, CO (US)

(73) Assignee: **Doskocil Manufacturing Company, Inc.**, Arlington, TX (US)

(**) Term: **14 Years**

(21) Appl. No.: **29/449,220**

(22) Filed: **Mar. 14, 2013**

(51) **LOC (10) Cl.** **30-02**

(52) **U.S. Cl.**
USPC **D30/109**

(58) **Field of Classification Search**
USPC D30/108-109, 112-113, 118-119;
119/161, 165-167, 416, 452-456, 459,
119/461, 465, 468, 472, 474, 482, 495-502,
119/512-513, 622, 28.5; D3/245-246, 273,
D3/276, 289, 301, 303
See application file for complete search history.

(56) **References Cited**

U.S. PATENT DOCUMENTS

2,481,565 A * 9/1949 Boretz 190/109
4,059,464 A * 11/1977 Geller et al. 156/66

D333,484 S * 2/1993 Neumeister D18/52
5,265,719 A * 11/1993 Wand 206/223
D381,199 S * 7/1997 Glasser D3/276
D398,082 S * 9/1998 Martz D30/109
6,298,993 B1 * 10/2001 Kalozdi 206/581
D524,995 S * 7/2006 Dudas D30/109
D573,793 S * 7/2008 Bakker D3/301

* cited by examiner

Primary Examiner — Cathy A MacCormac

(74) *Attorney, Agent, or Firm* — Eckert Seamans Cherin & Mellott, LLC; Brij K. Agarwal

(57) **CLAIM**

The ornamental design for a pet carrier, as shown and described.

DESCRIPTION

FIG. 1 is a perspective view of the pet carrier in the closed configuration;
FIG. 2 is front elevational view thereof;
FIG. 3 is a right side elevational view thereof;
FIG. 4 is a rear elevational view thereof;
FIG. 5 is a left side elevational view thereof;
FIG. 6 is a top plan view thereof; and
FIG. 7 is a bottom plan view thereof;
FIG. 8 is a perspective view of the pet carrier in the deployed configuration;
FIG. 9 is a front elevational view thereof;
FIG. 10 is a right side elevational view thereof;
FIG. 11 is a rear elevational view thereof;
FIG. 12 is a left side elevational view thereof;
FIG. 13 is a top plan view thereof; and
FIG. 14 is a bottom plan view thereof.
The broken lines are intended to illustrate non-claimed subject matter, are for illustration only and form no part of the claimed design.

1 Claim, 14 Drawing Sheets

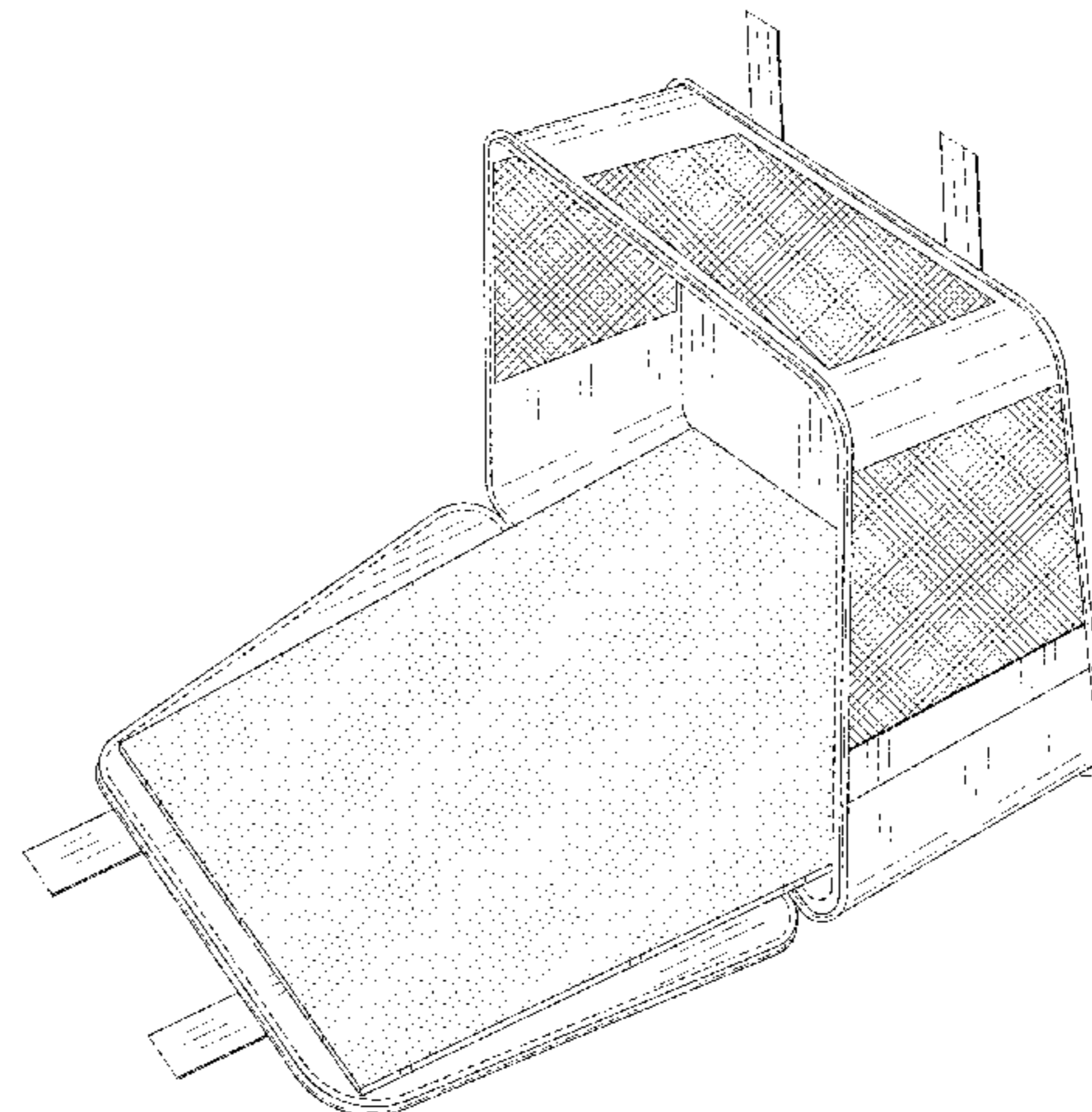
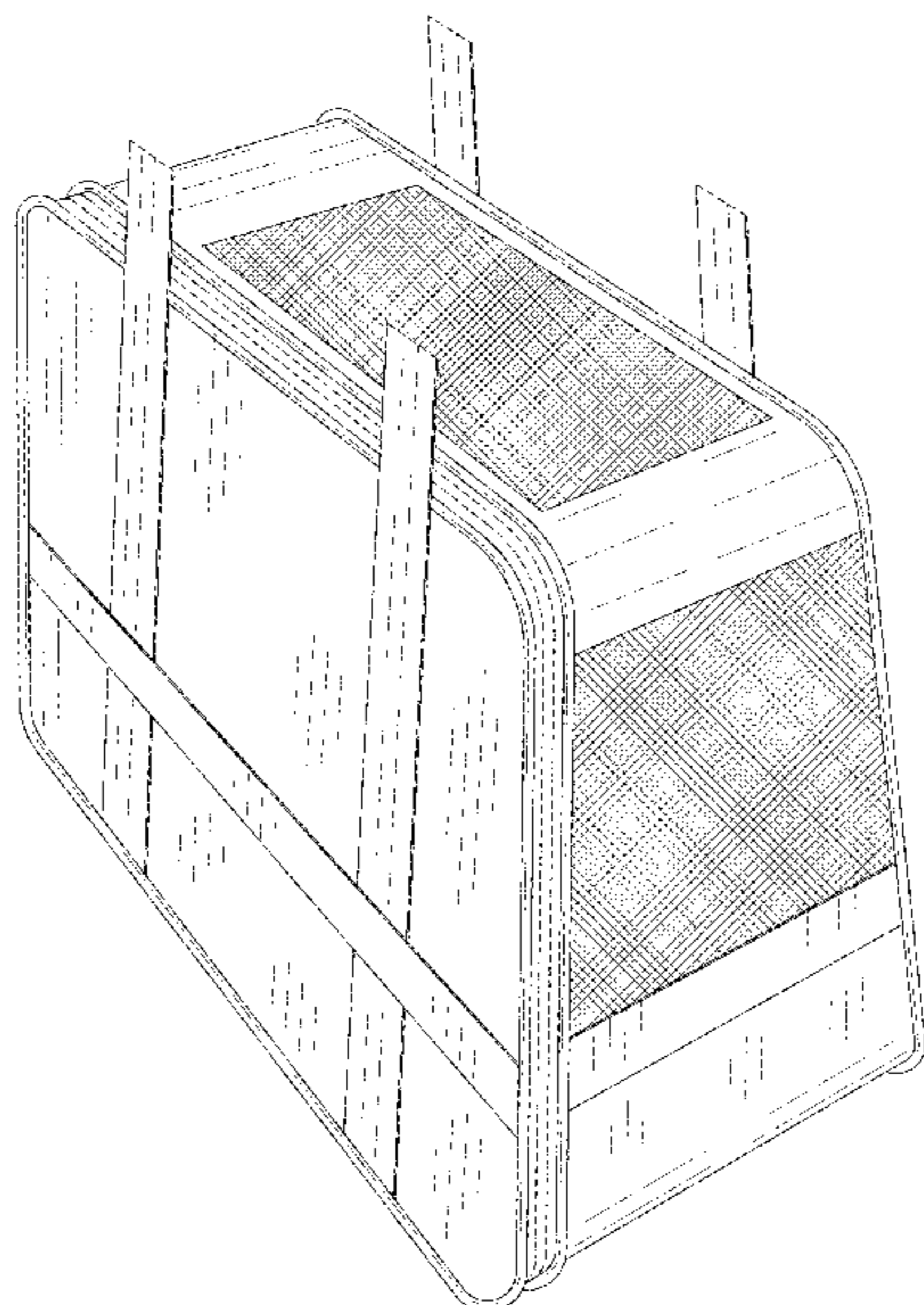

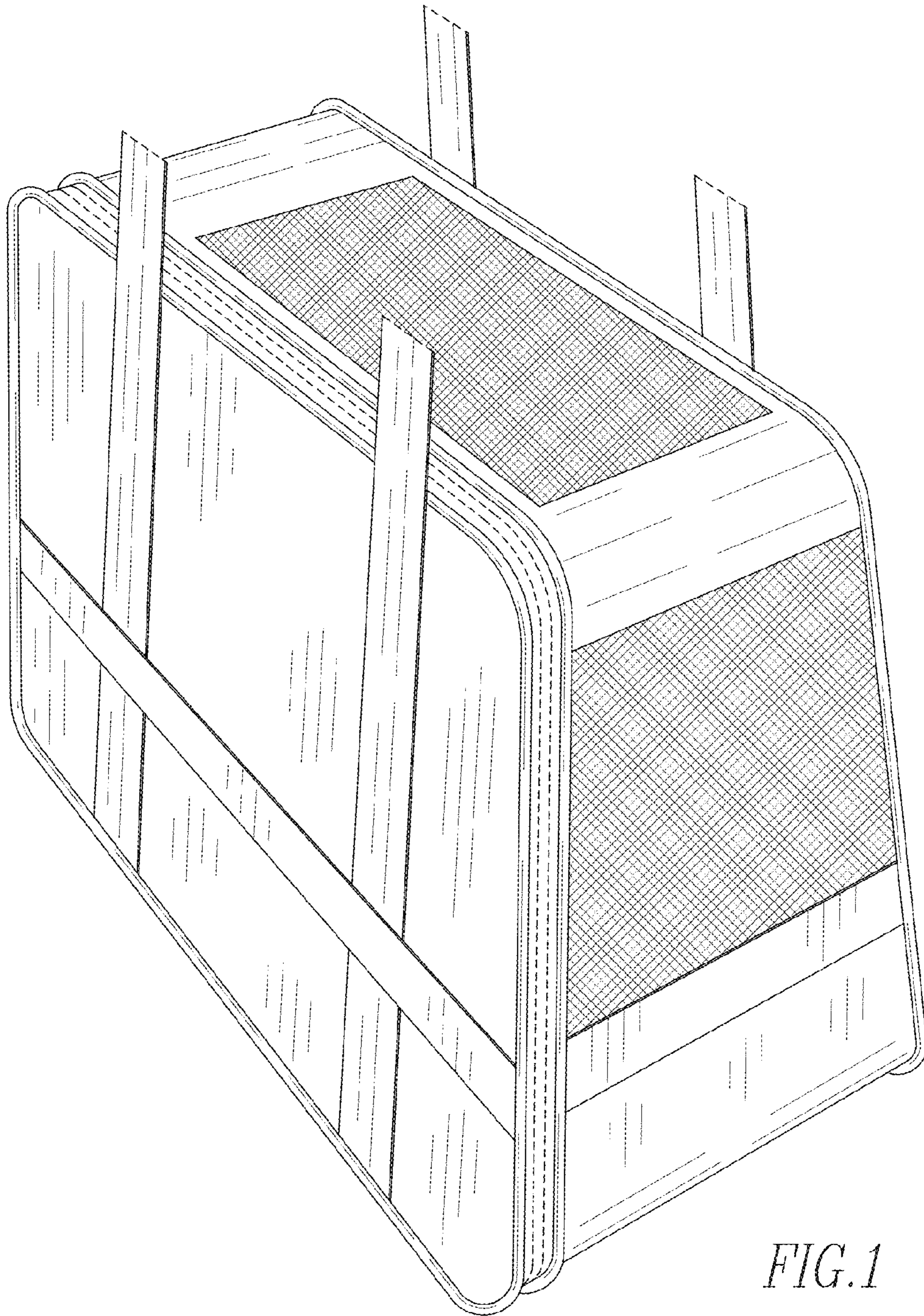

FIG. 1

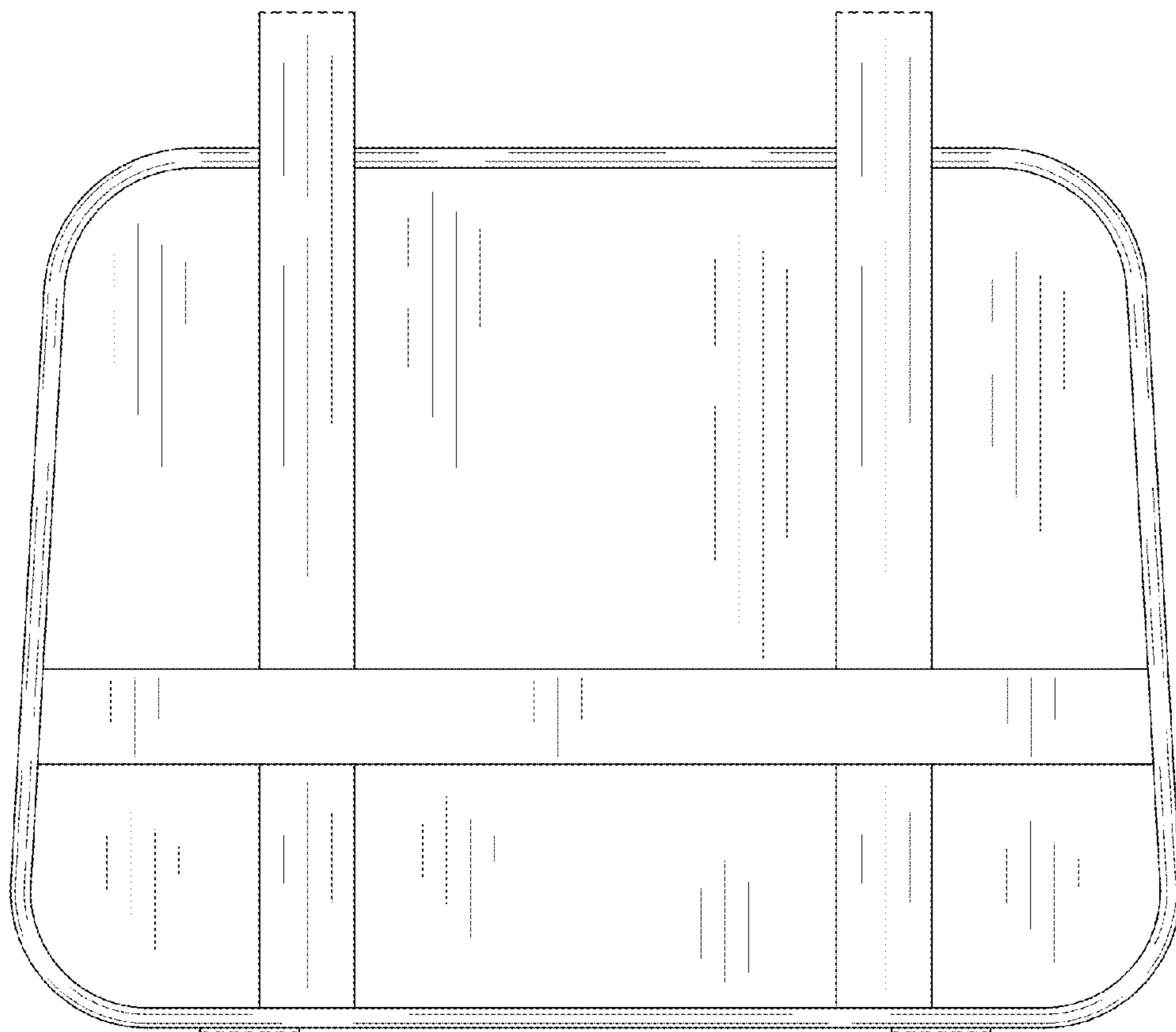

FIG. 2

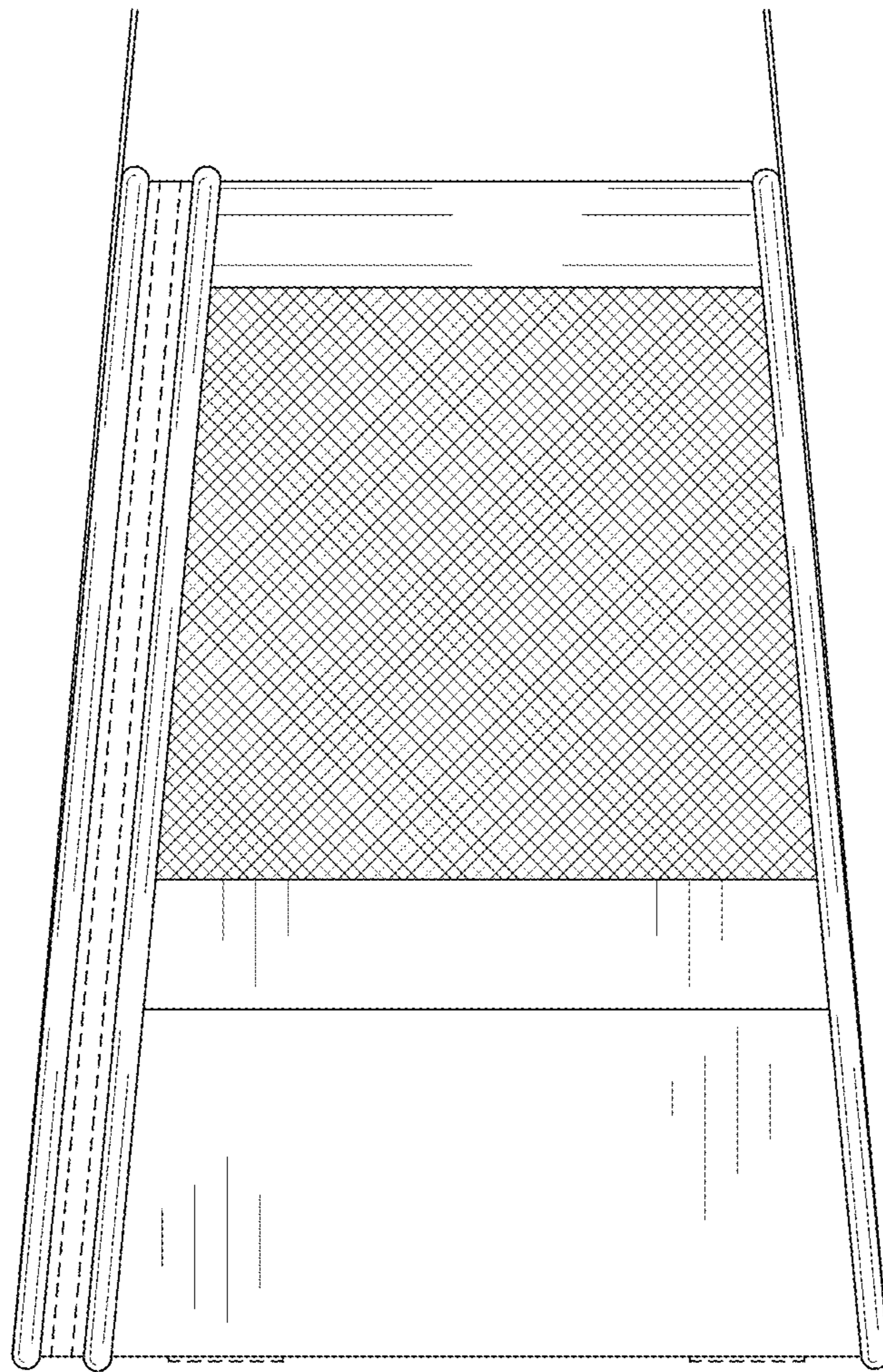

FIG. 3

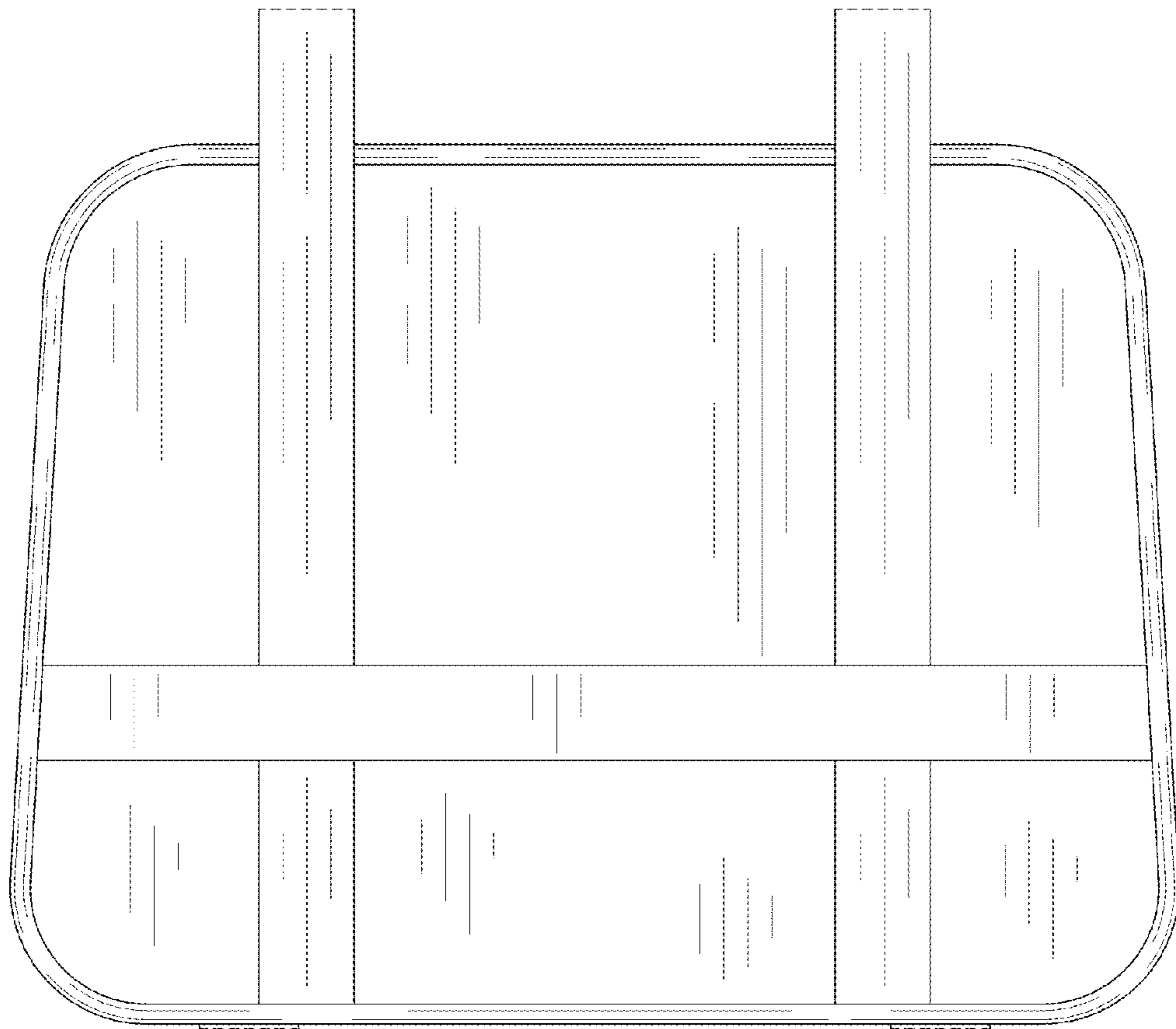

FIG. 4

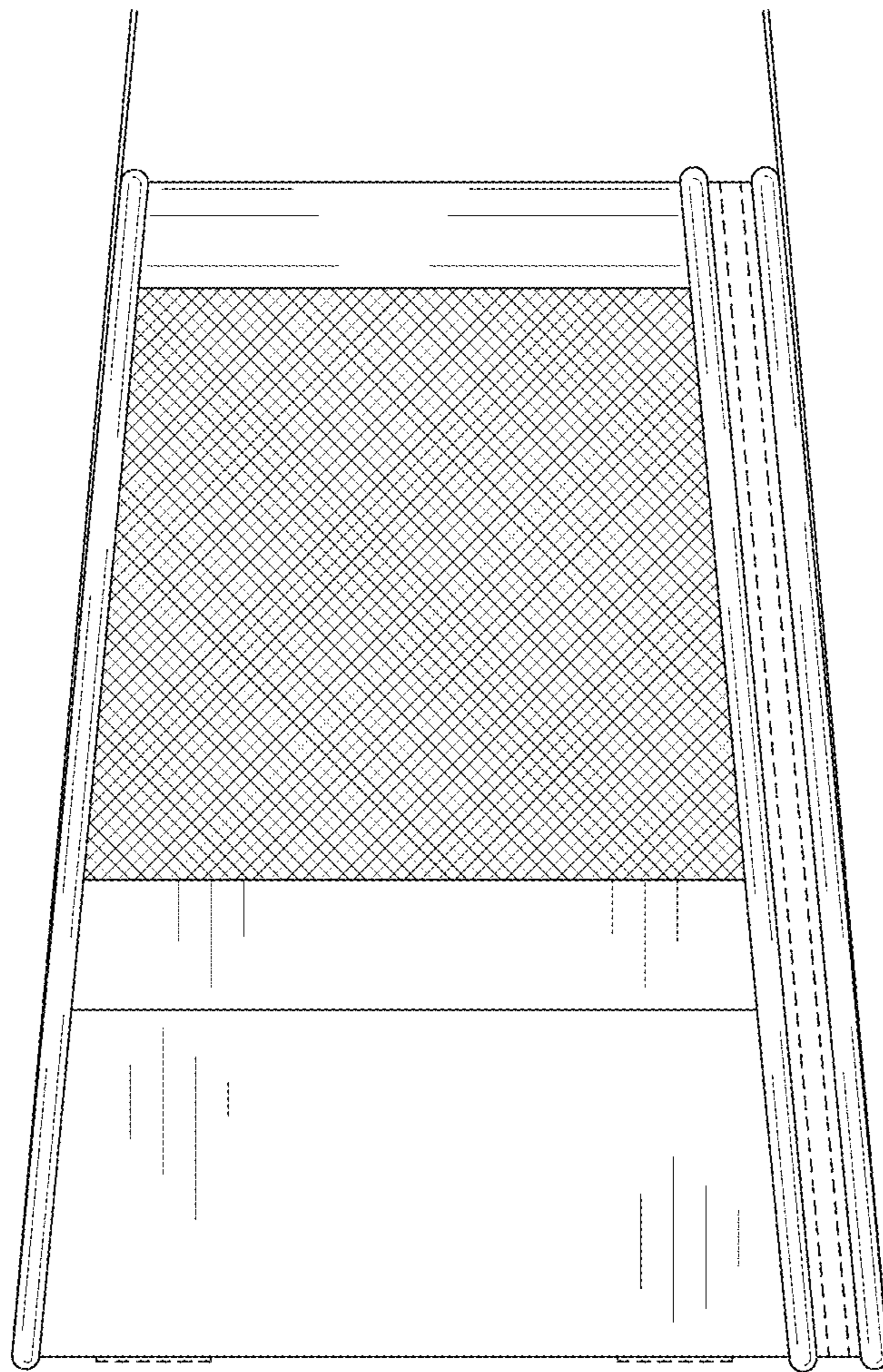

FIG. 5

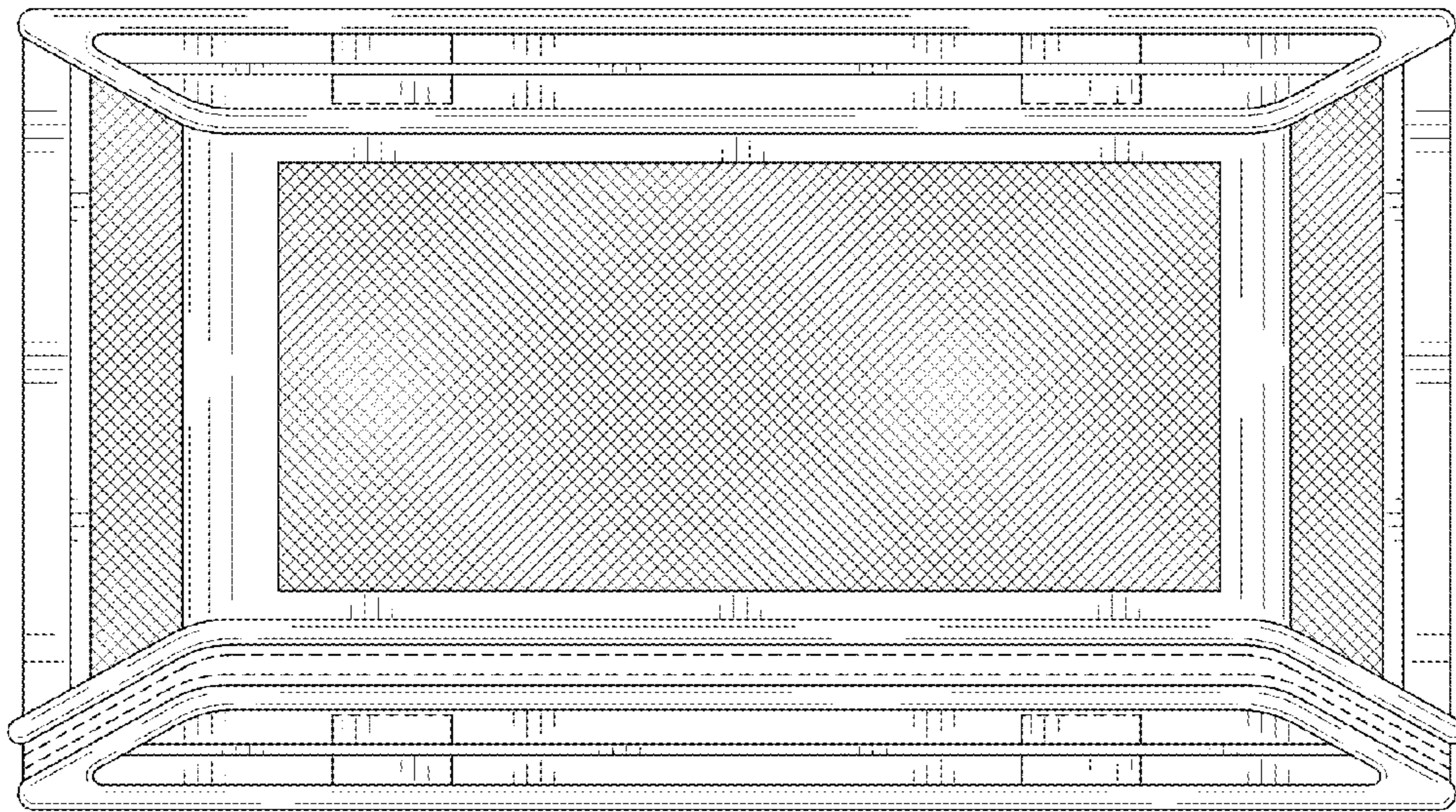

FIG. 6

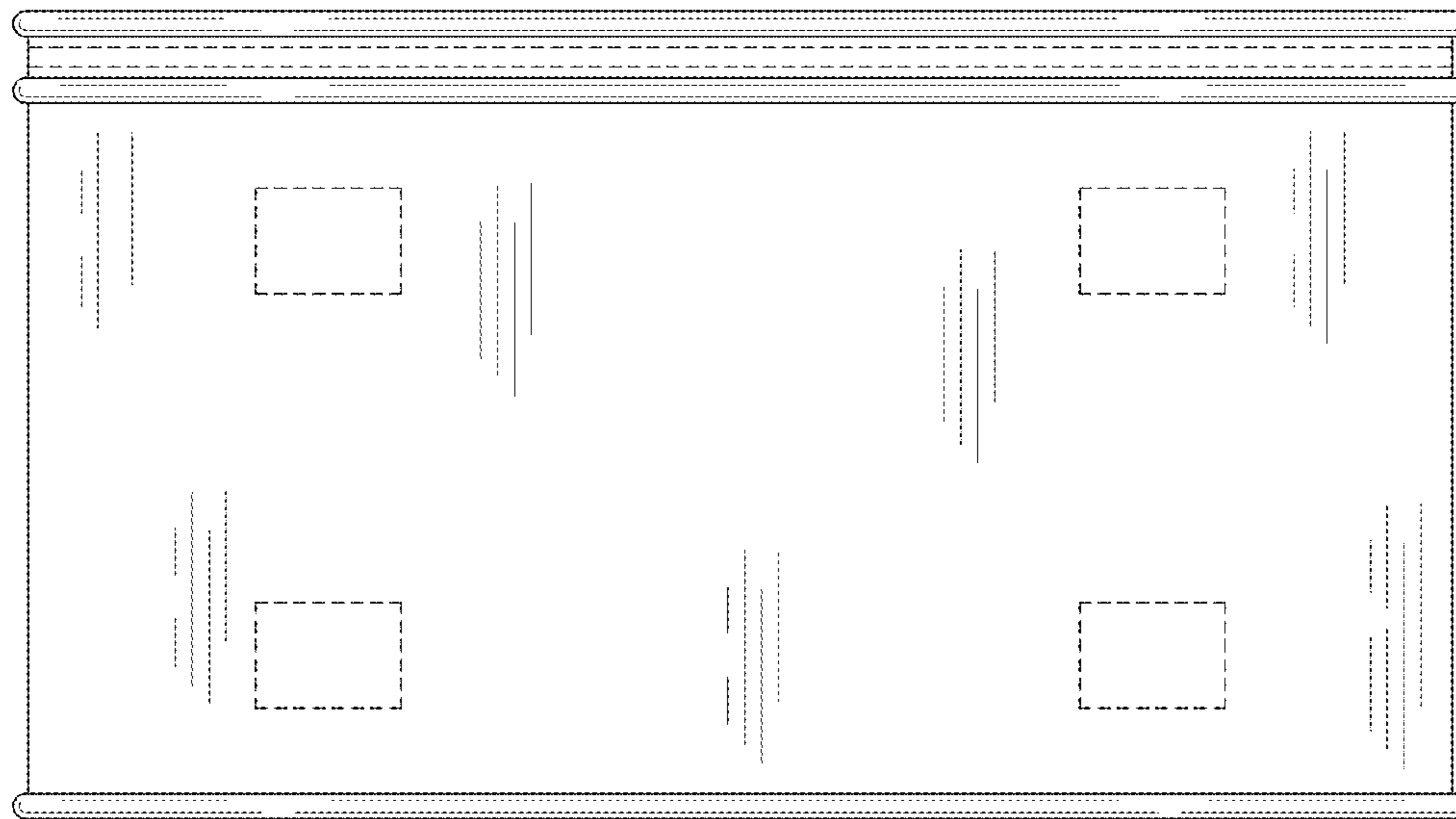
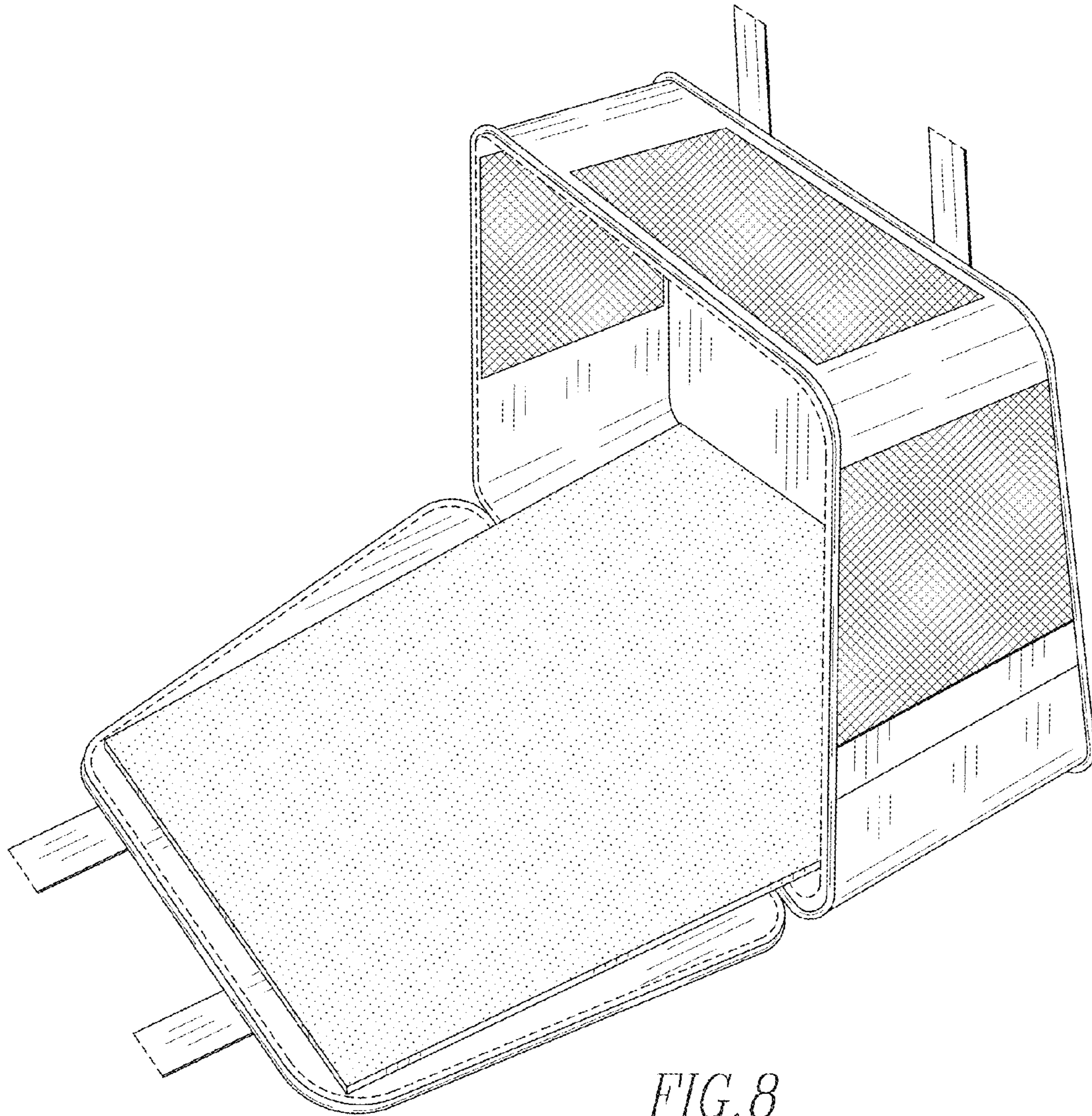

FIG. 7



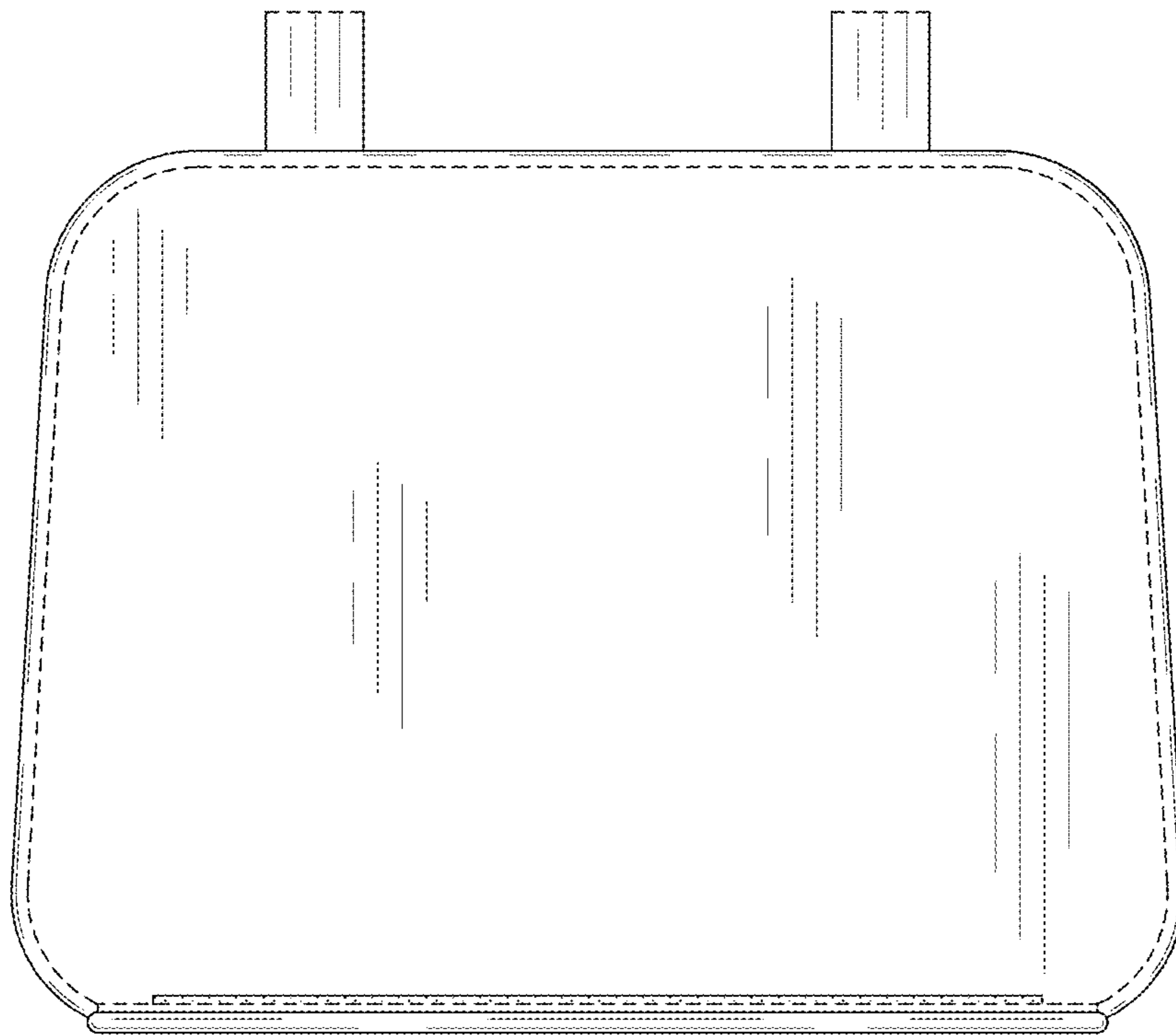

FIG. 9

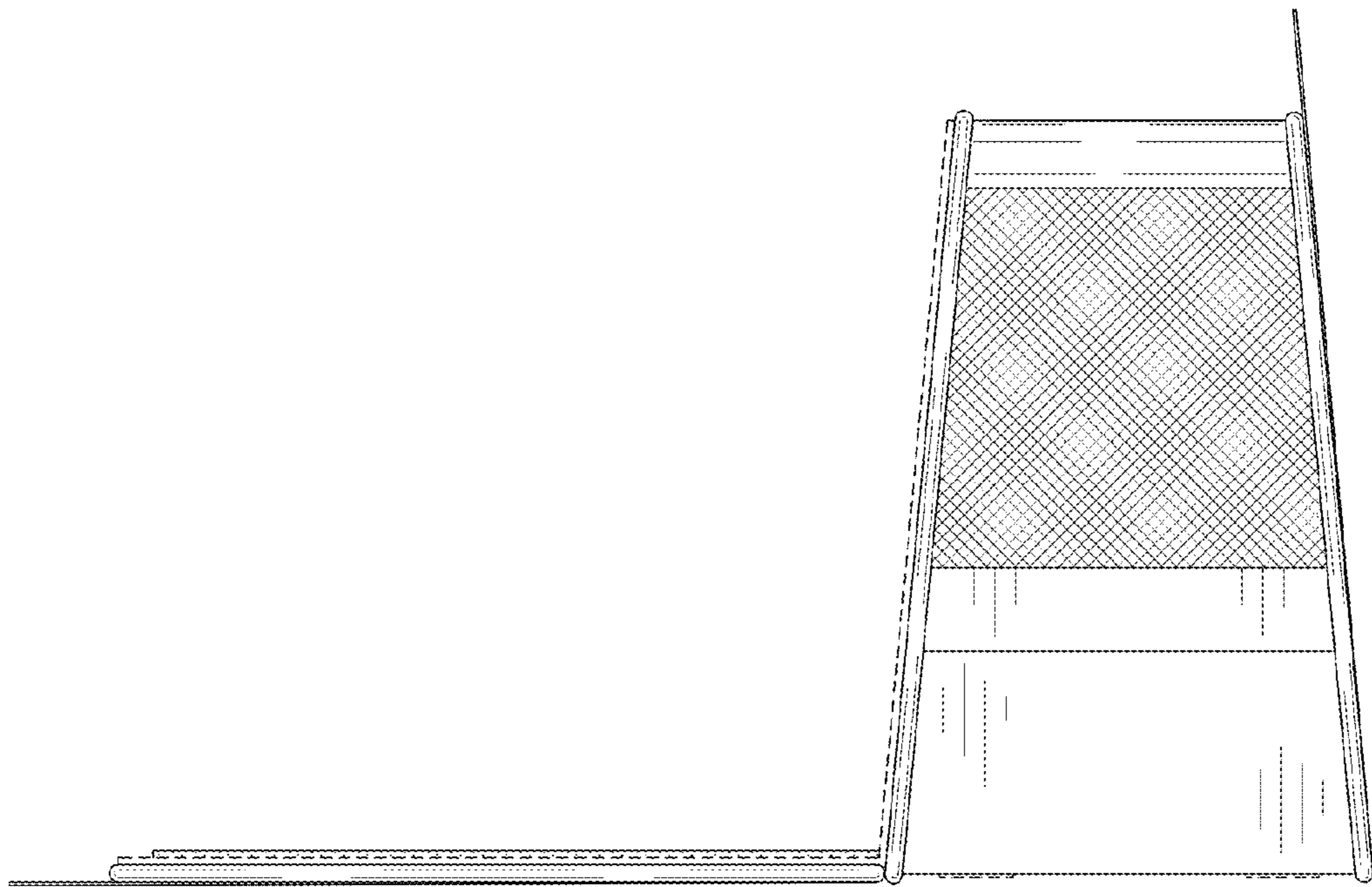

FIG. 10

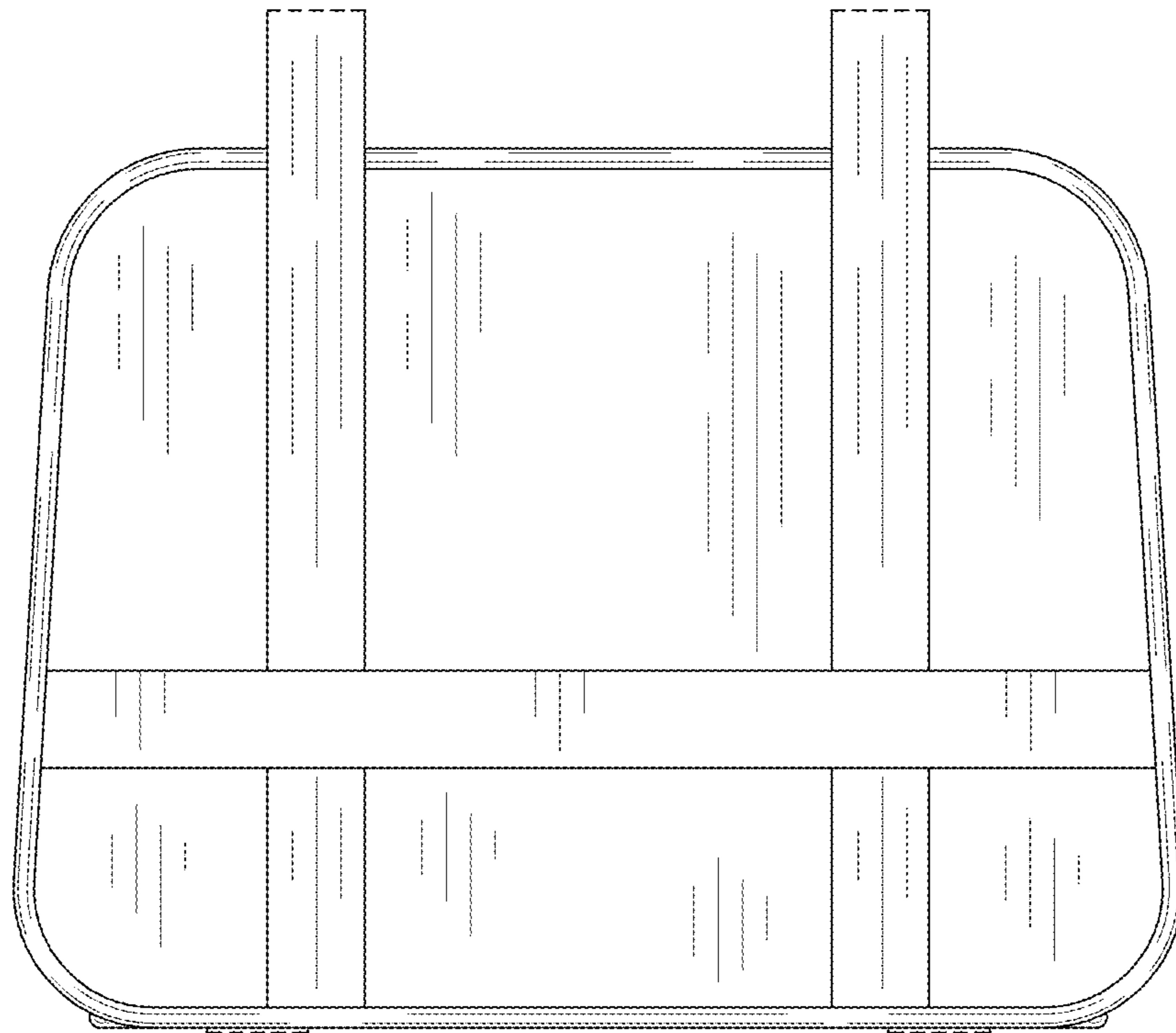

FIG. 11

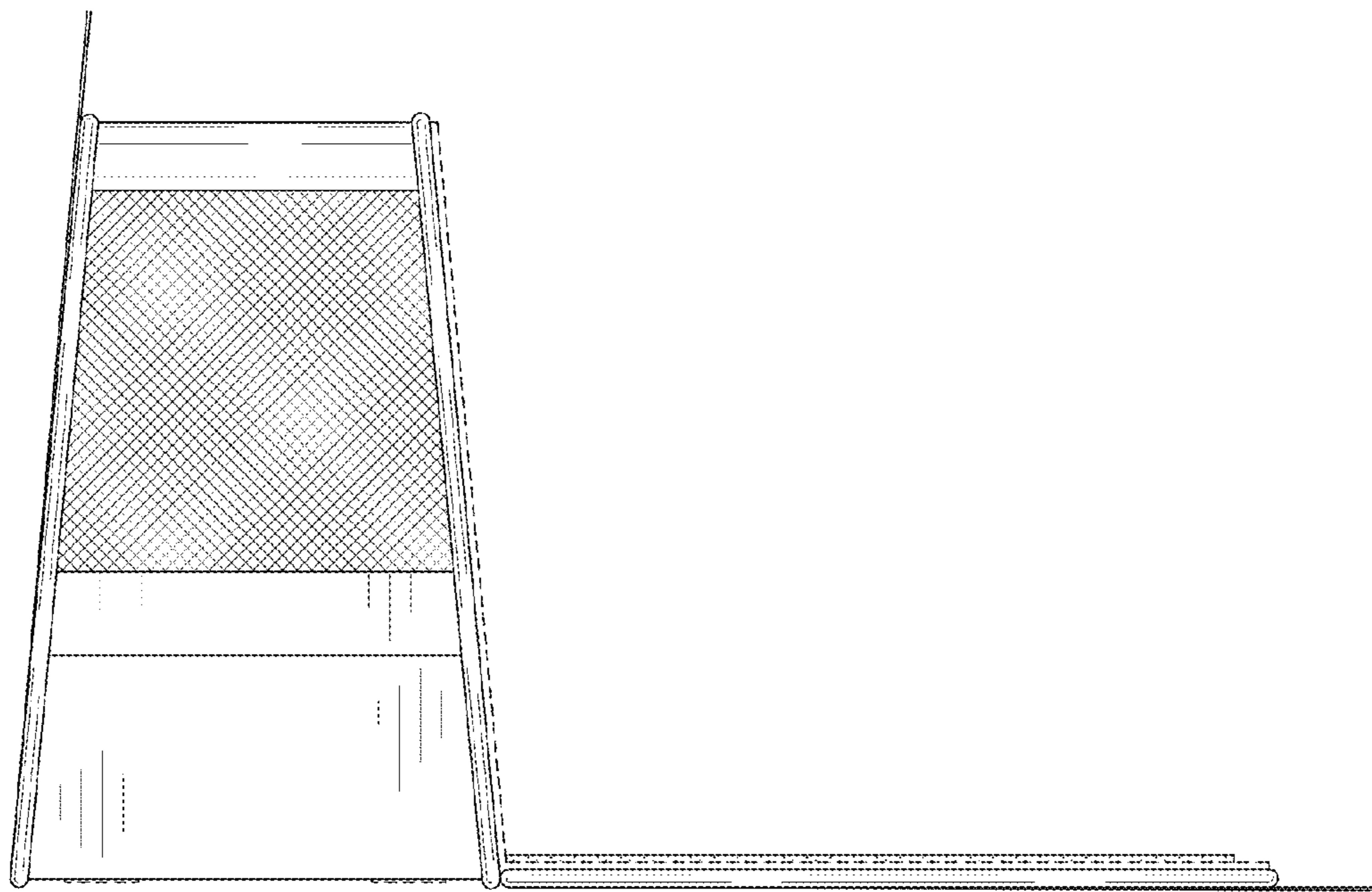

FIG.12

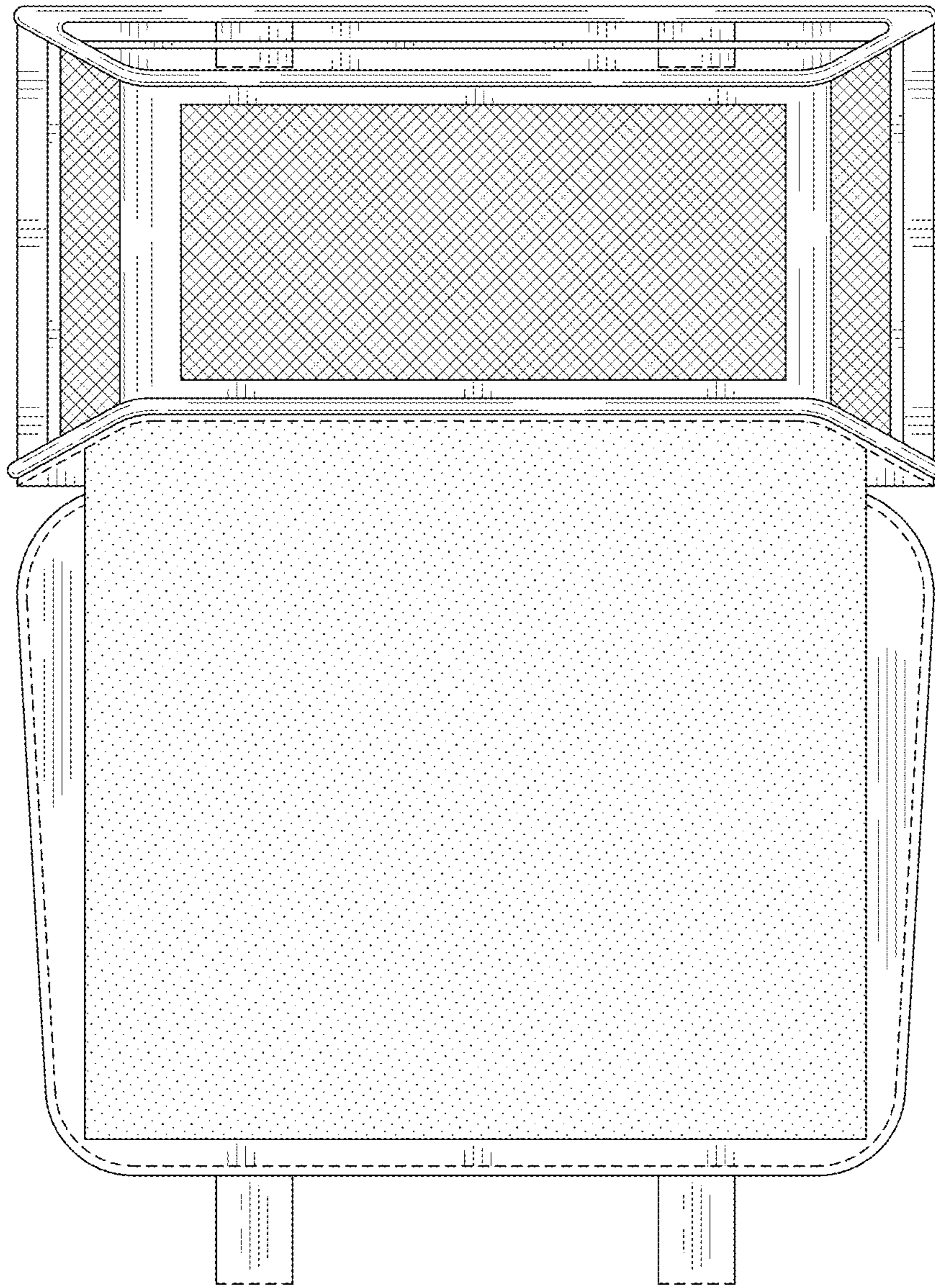

FIG. 13

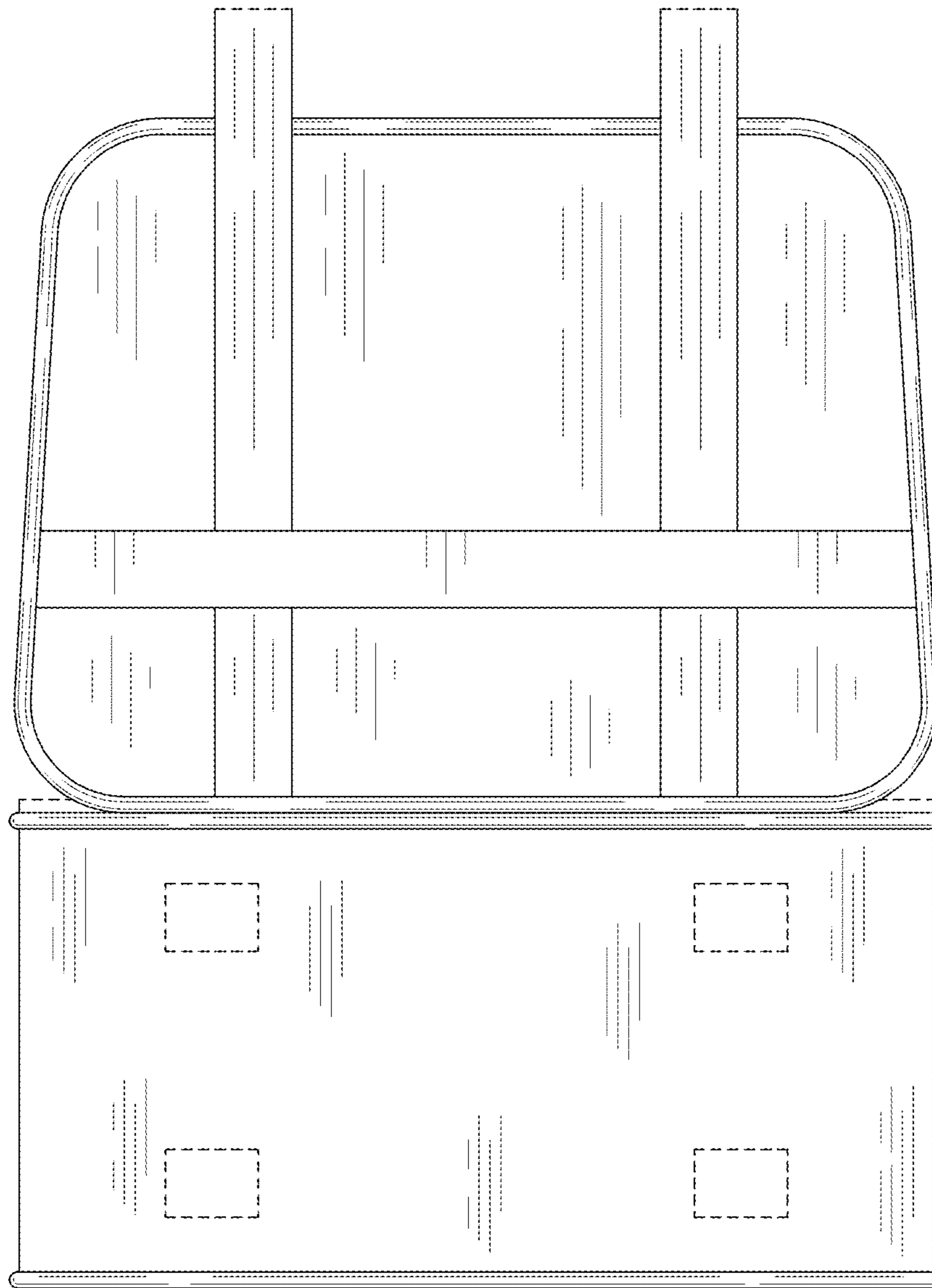

FIG. 14