



US00D724776S

(12) **United States Design Patent**
Sonneman

(10) **Patent No.:** **US D724,776 S**
(45) **Date of Patent:** **** Mar. 17, 2015**

- (54) **WALL MOUNTED RECTILINEAR LIGHT FIXTURE**
- (71) Applicant: **Contemporary Visions, L.L.C.**,
Larchmont, NY (US)
- (72) Inventor: **Robert A. Sonneman**, Mamaroneck, NY
(US)
- (73) Assignee: **Contemporary Visions, LLC**,
Larchmont, NY (US)
- (**) Term: **14 Years**
- (21) Appl. No.: **29/471,525**
- (22) Filed: **Nov. 1, 2013**
- (51) **LOC (10) Cl.** **26-03**
- (52) **U.S. Cl.**
USPC **D26/85**
- (58) **Field of Classification Search**
USPC D26/72, 85, 87, 88, 89, 90, 91, 92, 118,
D26/120; 362/147, 432, 404-408
See application file for complete search history.

- D671,255 S * 11/2012 Sonneman D26/85
- D674,953 S * 1/2013 Sonneman D26/87
- D689,647 S * 9/2013 Brott et al. D26/88
- D690,871 S * 10/2013 Kitts D26/85

* cited by examiner

Primary Examiner — Clare E Heflin
(74) *Attorney, Agent, or Firm* — Gottlieb, Rackman & Reisman, P.C.

(57) **CLAIM**
The ornamental design for a wall mounted rectilinear light fixture, as shown and described.

DESCRIPTION

FIG. 1 is a perspective view of the wall mounted rectilinear light fixture showing my new design;
FIG. 2 is a right side elevational view thereof;
FIG. 3 is a top plan view thereof;
FIG. 4 is a front elevational view thereof;
FIG. 5 is a bottom plan view thereof;
FIG. 6 is a left side elevational view thereof;
FIG. 7 is an enlarged sectional view of FIG. 3;
FIG. 8 is a second embodiment of my new design;
FIG. 9 is a right side elevational view thereof;
FIG. 10 is a top plan view thereof;
FIG. 11 is a front elevational view thereof;
FIG. 12 is a bottom plan view thereof;
FIG. 13 is a left side elevational view thereof;
FIG. 14 is an enlarged sectional view of FIG. 10.
The broken lines in FIGS. 7-9 and 11-14 are for the purposes of illustrating environment and form no part of the claimed design.

1 Claim, 4 Drawing Sheets

- (56) **References Cited**
U.S. PATENT DOCUMENTS
- D468,474 S * 1/2003 Poulton D26/90
- D557,442 S * 12/2007 Niemier D26/85
- D558,380 S * 12/2007 Starck D26/76
- D629,554 S * 12/2010 Gielen D26/76
- D649,278 S * 11/2011 Sabernig D26/90
- D651,336 S * 12/2011 Hartman D26/120
- D666,762 S * 9/2012 Gilad D26/87
- D666,763 S * 9/2012 Gilad D26/87
- D670,019 S * 10/2012 Sabernig D26/85

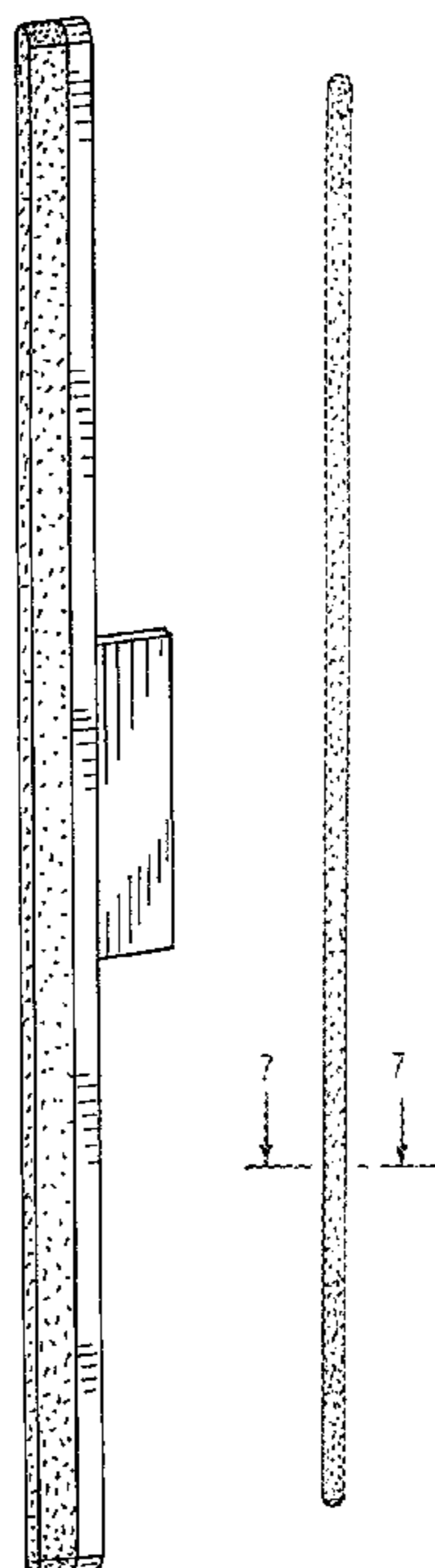

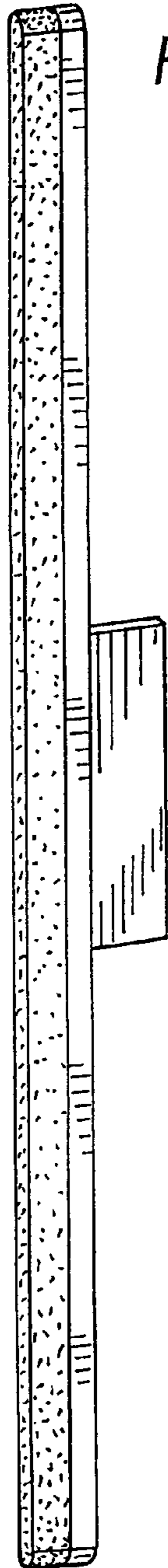

FIG. 1

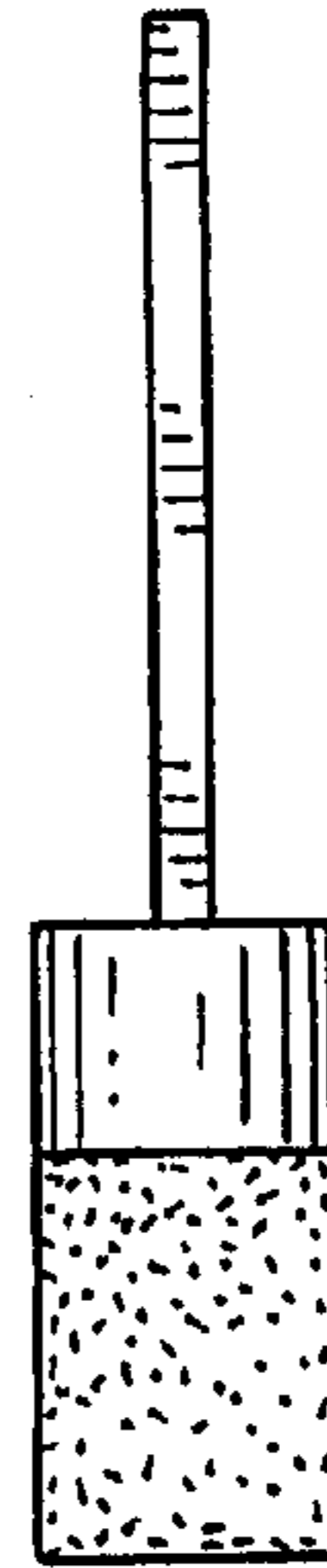

FIG. 2

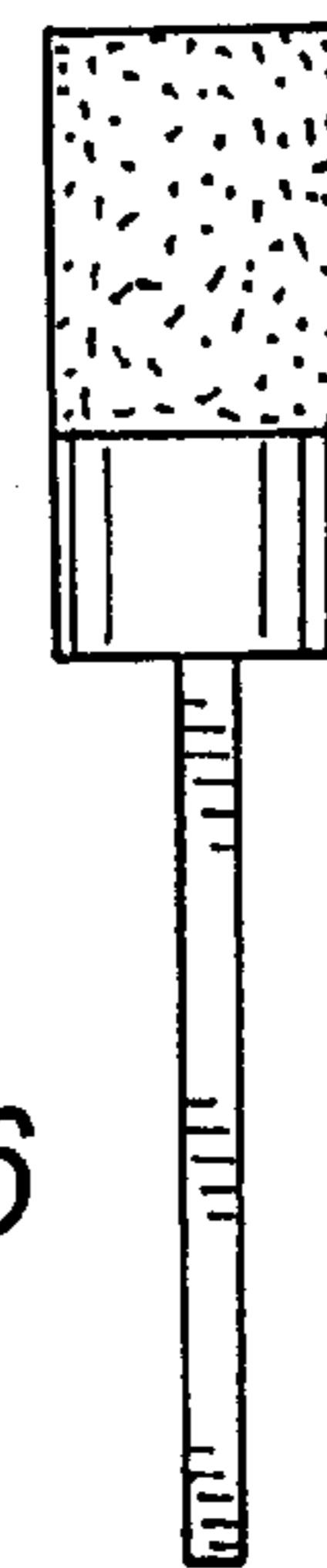

FIG. 6

FIG. 3

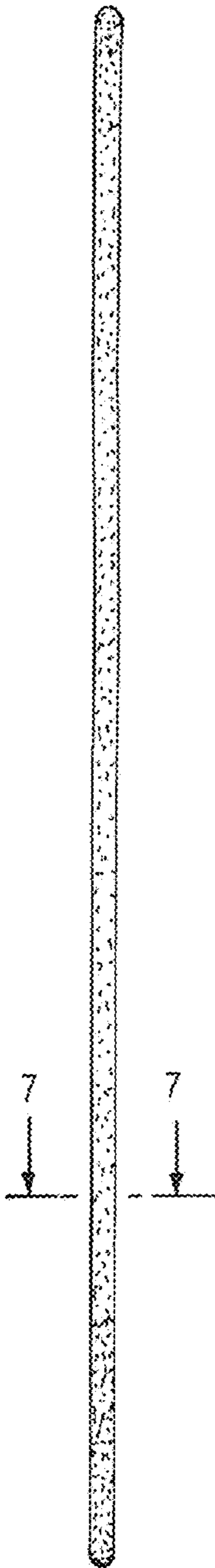

FIG. 5

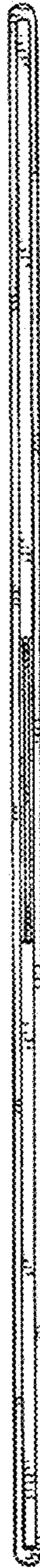

FIG. 4

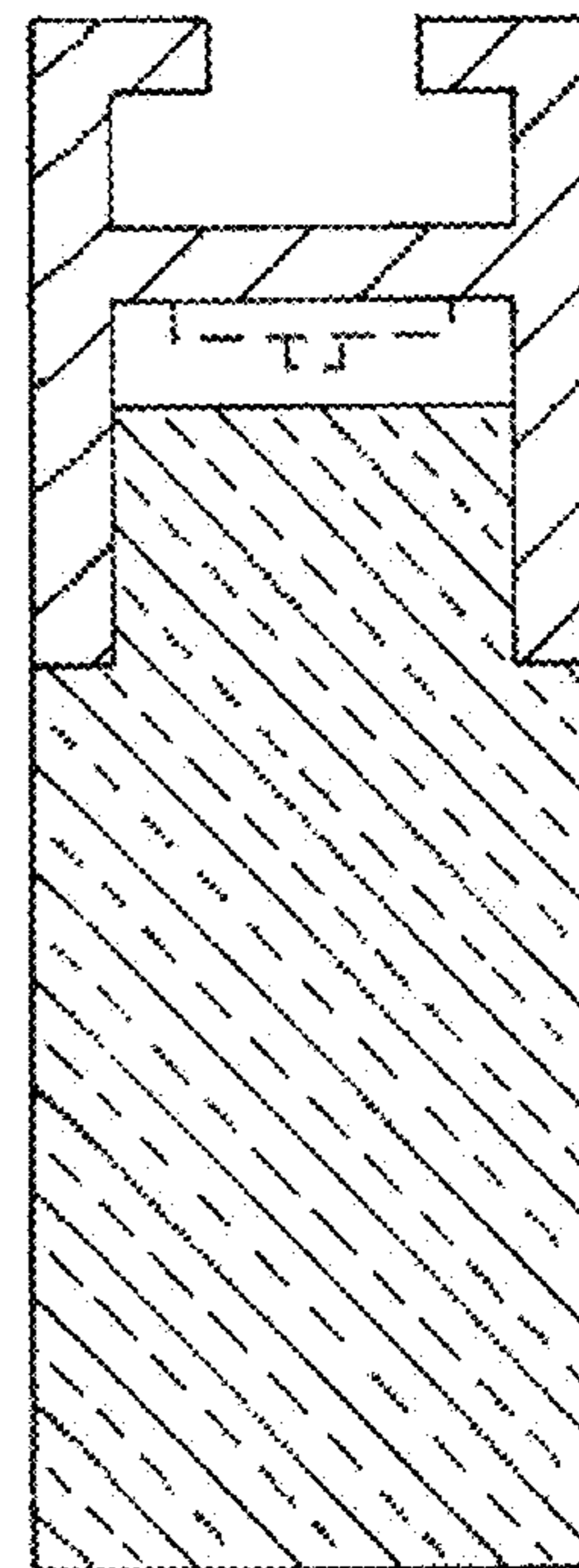
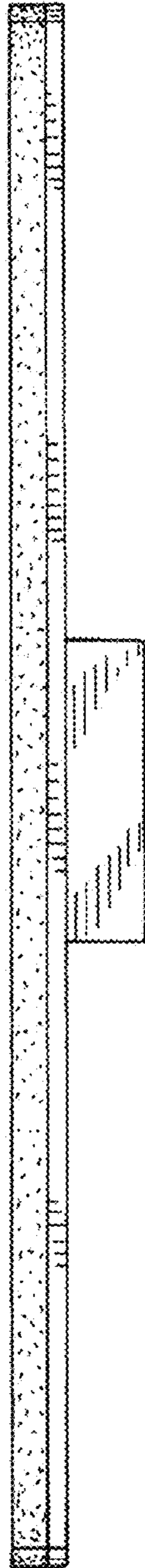

FIG. 7

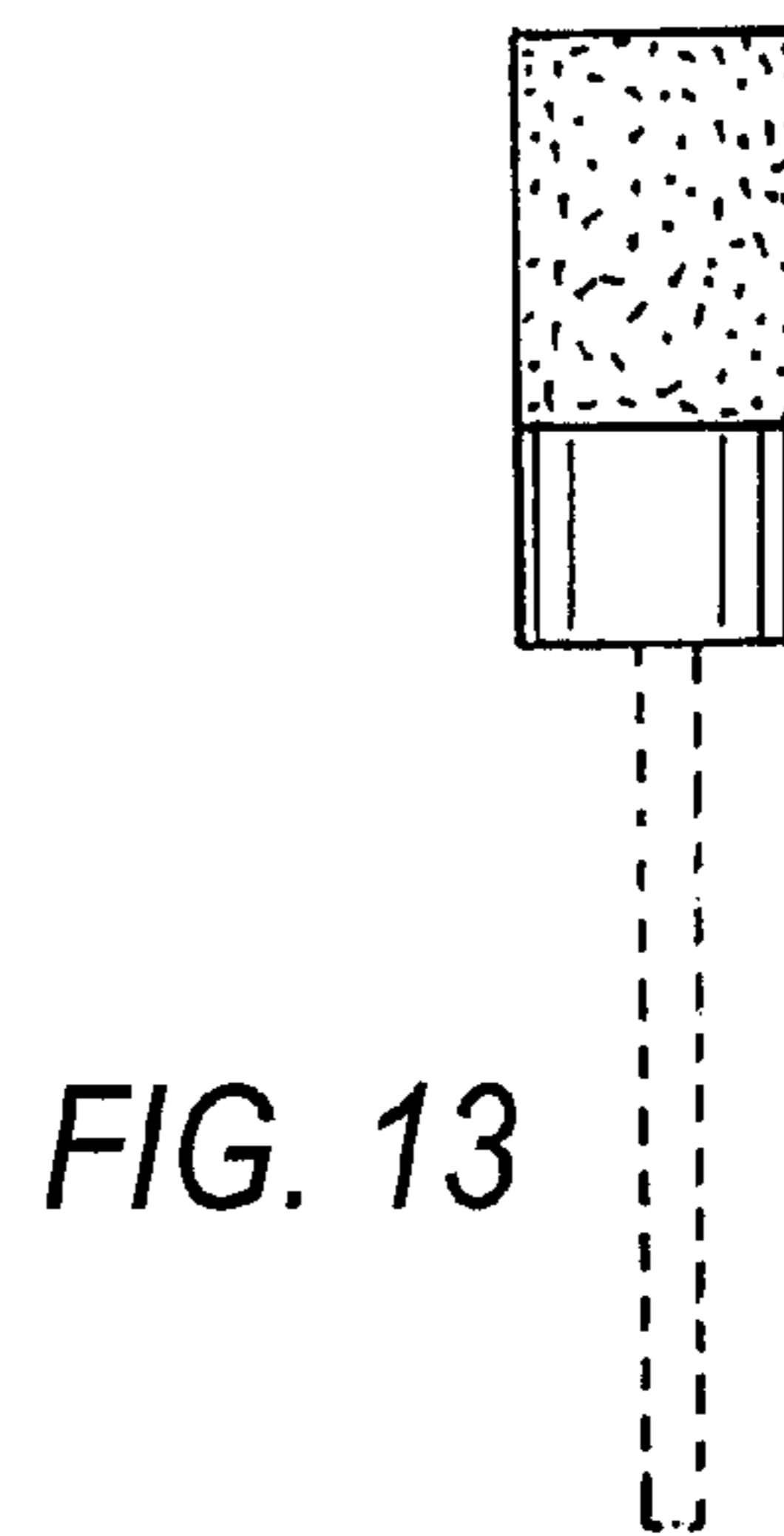
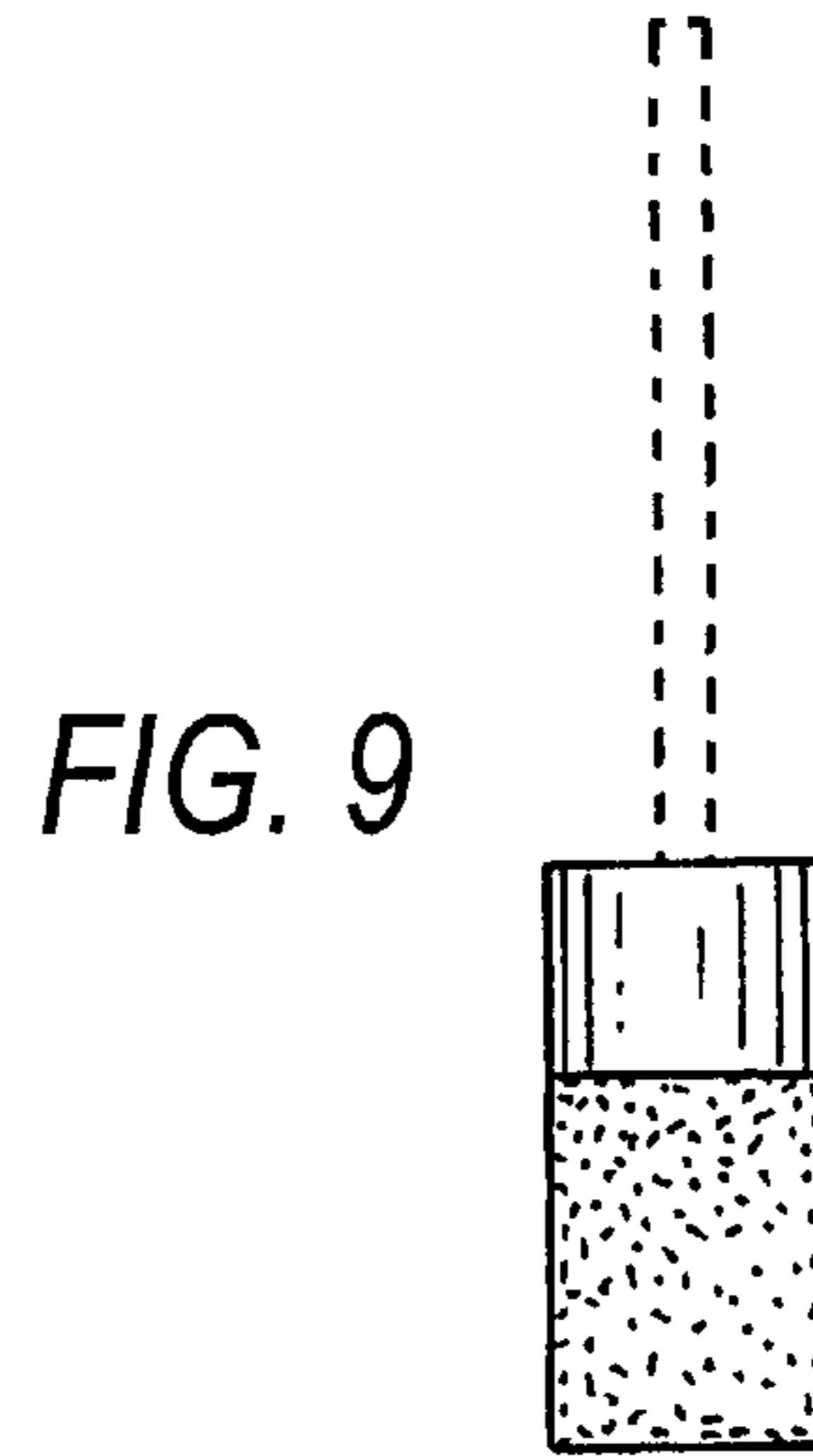
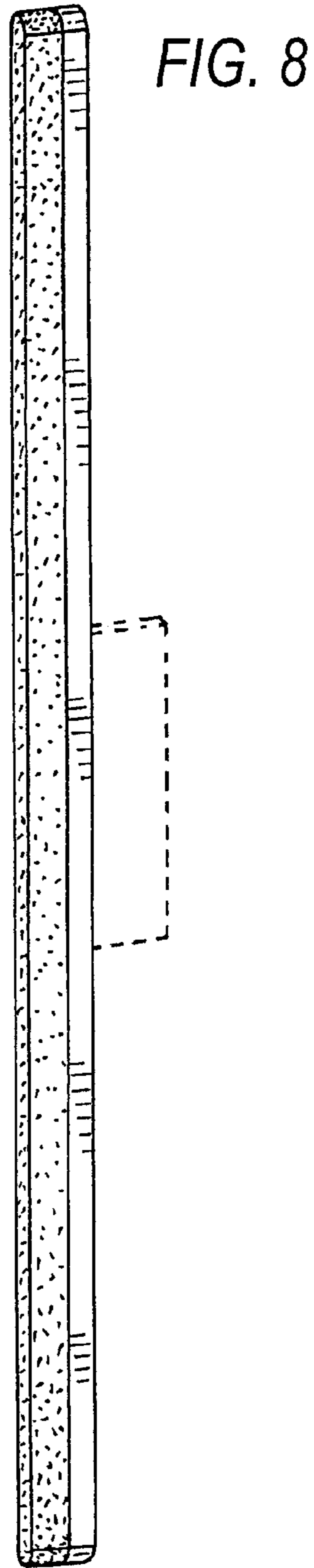

FIG. 10

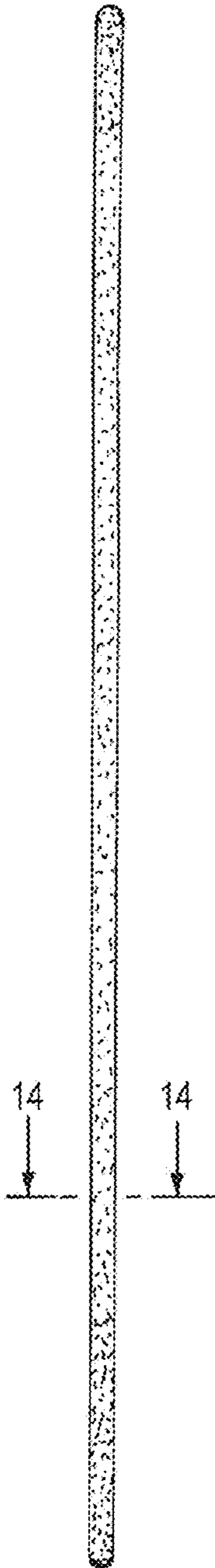

FIG. 12

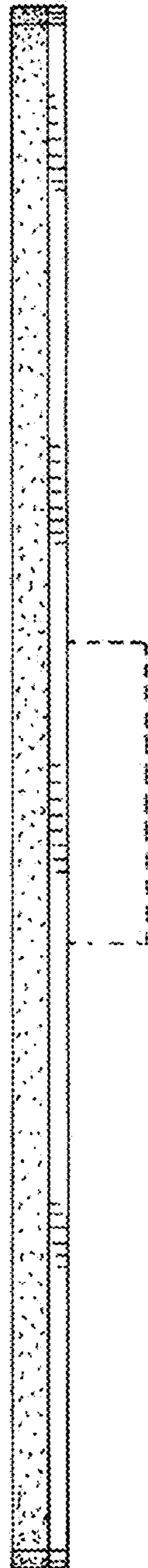

FIG. 11

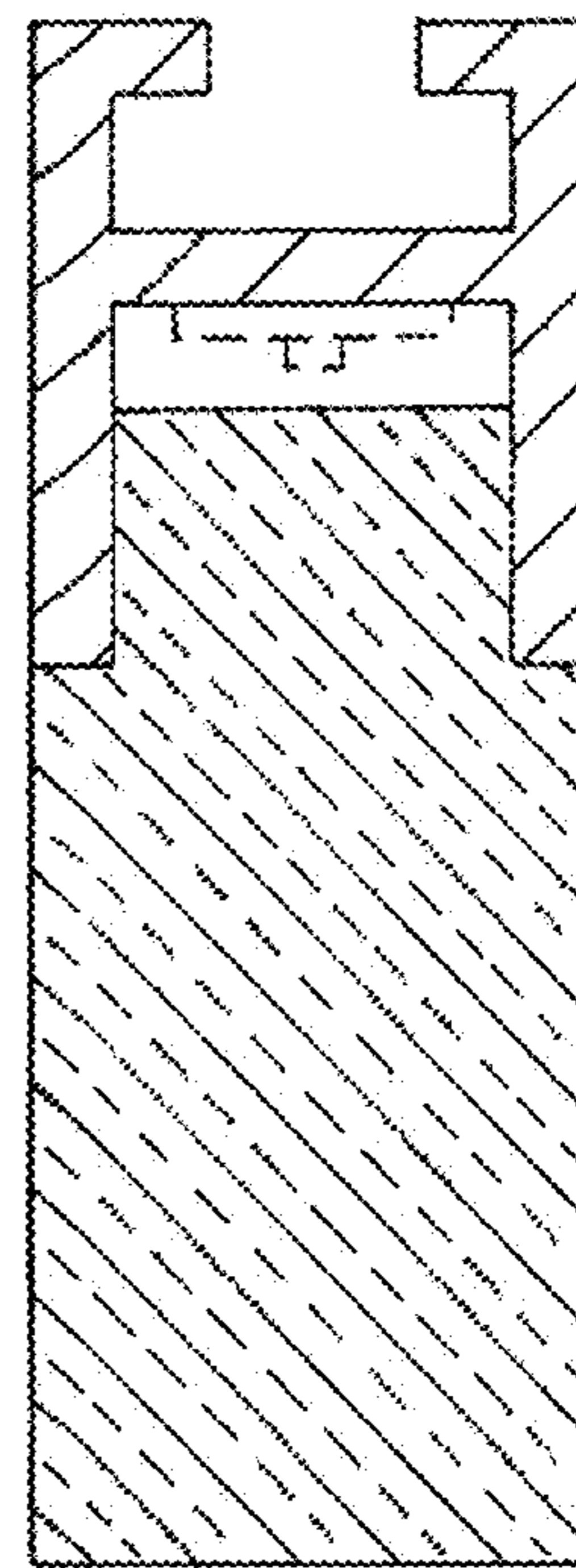

FIG. 14